

ESSENCE

ADVANTAGE

BY MASTERBRAND

PRICING & SPECIFICATIONS

AUGUST 2024 Supersedes all prior versions

SPEED. SERVICE. QUALITY.

WHAT'S NEW

Dive deep into color with this new product launch and discover a variety of additions to make designing easier. After all, we're all about improving the product lineup to give you the just-right options you need.



ADMIRAL EXPANSION

We've heard your requests for greater availability of Admiral and are excited to announce it has now to all SKUs and replacement parts in the Omni door style!

MORE NEW PRODUCTS & UPDATES

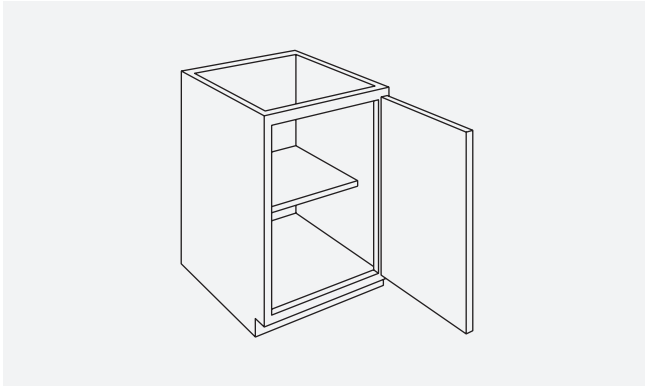

BASE 12" FULL HEIGHT

B12FHR

We've filled a gap in the offering with the new B12FHR, eliminating exceptions as you design.

Door hinge may be flipped for left hinge application.

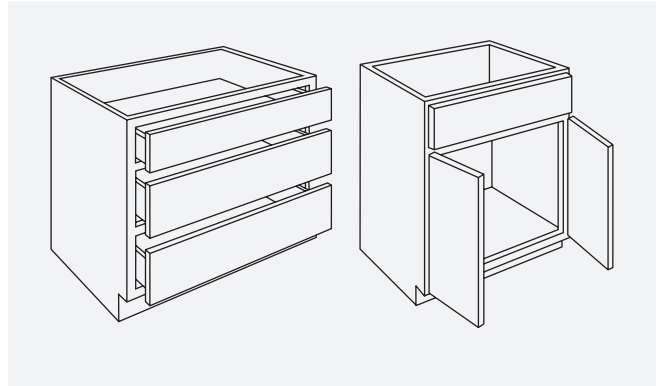

27" & 33" 3-DRAWER BASE & VANITY SINK BASE

3DB27, 3DB33, VSB273421

By popular request, we've added new widths of the Vanity Sink Base and 3-Drawer Base to create continuity across the offering.

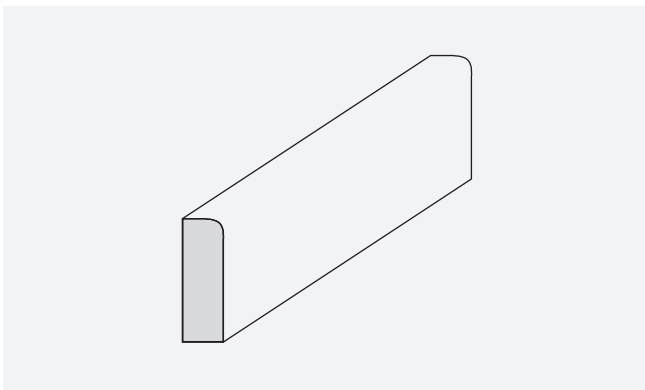

SCRIBE MOULDING

SCRIBE8

Our Scribe moulding now has an improved profile and will be replacing SSM8.

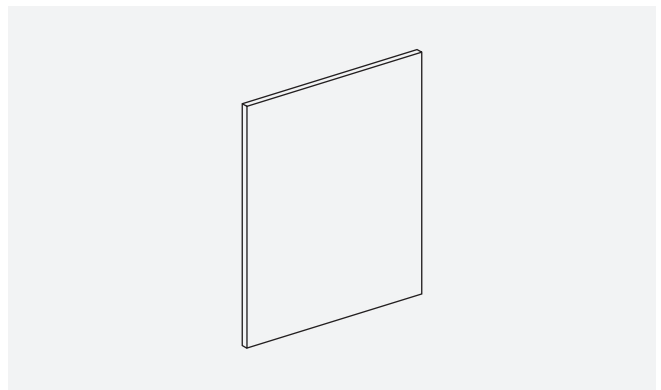

SNOW PLYWOOD END PANELS

BEPWD, WEP1230WD, TEP2496WD

When designing in our most popular finish, Snow, you now have the option for Plywood End Panels. This addition meets a popular request, while also providing price flexibility with the option of particle board still remaining.

ESSENCE

ADVANTAGE

BY MASTERBRAND

Your Essence Advantage user experience is our priority. The Essence Advantage Pricing and Specification Guide features hyperlink navigation, so you can quickly locate product specific to your project.

- The Indexes contain links to each unique product.
- The main Table of Contents contains links to the beginning of each section.
- The secondary Table of Contents at the beginning of each section contains links to product subcategories.
- Return to the beginning of each section by clicking on the title inside the black tab.
- Return to the main Table of Contents at any time by clicking on Essence Advantage logo at the bottom of each page.

If your preferred PDF search method is holding the Control and F keys and populating the search box with item codes or words, we've got you covered.

No matter how you choose to use this resource, we're glad you're specifying Essence Advantage!

TABLE OF CONTENTS

Index by Description	2
Index by Code	3
Customer Experience	4
How To Order	5
Door Styles	6-8
Product Specifications	9-16
Wall Cabinets	17-41
Base Cabinets	42-52
Universal Design Cabinets	53-58
Tall Cabinets	59-67
Vanity Cabinets	68-73
Fillers	74-76
Skins	77-78
Panels	79-81
Mouldings	82-88
Accessories	89-95

Description	Code	Page	Description	Code	Page
2 Drawer Base	2DB	45	Plywood End Panels	BEPWD, WEP12330WD, TEP2496WD	79
3 Drawer Base	3DB	46	Roll Tray Kits	RT__WD	92
3" Filler	F3__, TF396FH	75	Sink Base	SB	48
6" Filler	F6__, TF696FH	76	Stain & Paint	QUARTCOLOR, SSC	95
Accent Moulding, Flat Scribe	SM8	85	Starter Moulding, Shaker	STRS8	84
Accent Moulding, Light Baffle	LB2	86	Straight Valance / Baseboard	VV__	88
Accent Moulding, Small Scribe	SCRIBE8	85	Super Lazy Susan	SLS36R	51
Angled Corner Sink Front	ACSF	49	Tall End Panels	TEP2484LAM, TEP2496LAM, TEP3096LAM	79
Angled Corner Sink Front Bottom	ACSFB	49	Tilt-out Trays	TOT__	93
Base and Tall Panels with Filler Attached	BEPF1.5LAM, BEPF3LAM, TEP2496F1.5, TEP3096F1.5	80	Toeboard	TB8LAM18, TB8LAM14	88
Base Built-in Microwave with Drawer	BBMWD30	47	Touch-up Kit	TUK	95
Base Corner Single Door	BC__S	50	Universal Design, 3 Drawer Base	3DB__32.5	55
Base Double Door	B	44	Universal Design, Base Corner Single Door	BC__32.5S	57
Base Double Door - Full Height	B__FH	45	Universal Design, Base Double Door	B__32.5	55
Base Easy Reach	BER__R	51	Universal Design, Base Built-in Microwave with Drawer	BBMWD3032.5	56
Base End Decorative Door Panel Kit	BEDSD	81	Universal Design, Base Single Door	B__32.5R	54
Base Lazy Susan	BLS36R	52	Universal Design, Base Sink Removable	BSR__32.5	56
Base Single Door	B__R	43	Universal Design, Sink Base	SB__32.5	0
Base Single Door - Full Height	B__FHR	44	Universal Design, Super Lazy Susan	SLS3632.5R	58
Base Wastebasket	BWB	47	Universal Design, Vanity Base Sink Removable	VBSR__32.521	58
Classic Square Wood Hood	WHS36	90	Utility Double Door	U24__24	62
Classic Wood Hood Chimney	WHC36	90	Utility Double Door	U30__24	64
Corner Moulding, Inside Corner	ICM8	86	Utility Single Door	U18__24R	60
Corner Moulding, Outside Corner	OCM8	87	Vanity Base Single Door	VB__3421R	71
Corner Moulding, Quarter Round	QRM	87	Vanity Drawer Base	VDB__32.521	69
Country Sink Base	CNTYSB	48	Vanity Drawer Base	VDB__3421	72
Crown Moulding, Cove Crown	COVECROWN8	83	Vanity Sink Base	VS__32.521	70
Crown Moulding, Large Shaker Crown	LSHAKER8	84	Vanity Sink Base	VS__3418	70
Crown Moulding, Small Cove Crown	SMCOVECROWN8	83	Vanity Sink Base	VS__3421	72
Crown Moulding, Solid Wood Crown	SWCRM8	82	Vanity Sink Drawer Base	2VSD__3421	72
Crown Moulding, Solid Wood Large Crown	SWLCRM8	82	Vanity Sink Drawer Base	3VSD__3421	73
Cutlery Insert Wood Organizer	CIW	94	Wall Corner Double Door	WC__S	37
Diagonal Wall	DW____R	39	Wall Corner Single Door	WC__S	36
Diagonal Wall Cut-for-glass	DWCG	40	Wall Cut-for-glass	WCG	30
End Panel Skins	WEPS42LAM14, BEPS34.514, TEPS96LAM14	77	Wall Double Door	W	19
Easy Reach Wall Corner	ER__	41	Wall End Decorative Door Panel Kit	WED	81
Finished Back Skins	BP4834.514, BP4896LAM14	78	Wall Single Door	W__R	21
Microwave Wall Cabinet	MW3018	90	Wood Hood Blower, 400 CFM	BLOWER400	91
Mini Touch-up Kit	MTUK	95			
Oven 3 Drawers	OC3D33__24	66			

Code	Description	Page	Code	Description	Page
2DB	2 Drawer Base	45	RT__WD	Roll Tray Kits	92
2VSD__3421	Vanity Sink Drawer Base	72	SB	Sink Base	48
3DB	3 Drawer Base	46	SCRIBEB8	Accent Moulding, Small Scribe	85
3DB__32.5	Universal Design, 3 Drawer Base	55	SLS3632.5R	Universal Design, Super Lazy Susan	58
3VSD__3421	Vanity Sink Drawer Base	73	SLS36R	Super Lazy Susan	51
ACSF	Angled Corner Sink Front	49	SM8	Accent Moulding, Flat Scribe	85
ACSF8	Angled Corner Sink Front Bottom	49	SMCOVECROWN8	Crown Moulding, Small Cove Crown	83
B	Base Double Door	44	SSC	Stain & Paint	95
B__32.5	Universal Design, Base Double Door	55	STRS8	Starter Moulding, Shaker	84
B__32.5R	Universal Design, Base Single Door	54	SWCRM8	Crown Moulding, Solid Wood Crown	82
B__FH	Base Double Door - Full Height	45	SWLCRM8	Crown Moulding, Solid Wood Large Crown	82
B__FHR	Base Single Door - Full Height	44	TB8LAM14	Toeboard	88
B__R	Base Single Door	43	TB8LAM18	Toeboard	88
BC__32.5S	Universal Design, Base Corner Single Door	57	TEP2484LAM	Tall End Panel	79
BC__S	Base Corner Single Door	50	TEP2496F1.5	Tall Panel with Filler Attached	80
BBMWD30	Base Built-in Microwave with Drawer	47	TEP2496LAM	Tall End Panel	79
BBMWD3032.5	Universal Design, Base Built-in Microwave with Drawer	56	TEP2496WD	Plywood End Panel	79
BEDSD	Base End Decorative Door Panel Kit	81	TEP3096F1.5	Tall Panel with Filler Attached	80
BEPF1.5LAM	Base Panel with Filler Attached	80	TEP3096LAM	Tall End Panel	79
BEPF3LAM	Base Panel with Filler Attached	80	TEPS96LAM14	End Panel Skins	77
BEPS34.514	End Panel Skins	77	TF396FH	3" Filler, Tall	75
BEPWD	Plywood End Panel	79	TF696FH	6" Filler, Tall	76
BER__R	Base Easy Reach	51	TOT__	Tilt-out Trays	93
BLOWER400	Wood Hood Blower, 400 CFM	91	TUK	Touch-up Kit	95
BLS36R	Base Lazy Susan	52	U18__24R	Utility Single Door	60
BP4834.514	Finished Back Skins	78	U24__24	Utility Double Door	62
BP4896LAM14	Finished Back Skins	78	U30__24	Utility Double Door	64
BSR__32.5	Universal Design, Base Sink Removable	56	VB__3421R	Vanity Base Single Door	71
BWB	Base Wastebasket	47	VDB__32.521	Vanity Drawer Base	69
CIW	Cutlery Insert Wood Organizer	94	VDB__3421	Vanity Drawer Base	71
CNTYSB	Country Sink Base	48	VSB__32.521	Vanity Sink Base	70
COVECROWN8	Crown Moulding, Cove Crown	83	VSB__3418	Vanity Sink Base	70
DW_____R	Diagonal Wall	39	VSB__3421	Vanity Sink Base	72
DWCG	Diagonal Wall Cut-for-glass	40	VBSR__32.521	Universal Design, Vanity Base Sink Removable	58
ER__	Easy Reach Wall Corner	41	VV__	Straight Valance / Baseboard	88
F3__	3" Filler	75	W	Wall Double Door	19
F6__	6" Filler	76	W____R	Wall Single Door	21
ICM8	Corner Moulding, Inside Corner	86	WC____S	Wall Corner Double Door	37
LB2	Accent Moulding, Light Baffle	86	WC____S	Wall Corner Single Door	36
LSHAKER8	Crown Moulding, Large Shaker Crown	84	WCG	Wall Cut-for-glass	30
MTUK	Mini Touch-up Kit	95	WED	Wall End Decorative Door Panel Kit	81
MW3018	Microwave Wall Cabinet	35	WEP1230WD	Plywood End Panel	79
OC3D33__24	Oven 3 Drawers	66	WEPS42LAM14	End Panel Skins	77
OCM8	Corner Moulding, Outside Corner	87	WHC36	Classic Wood Hood Chimney	90
QRM	Corner Moulding, Quarter Round	87	WHS36	Classic Square Wood Hood	90
QUARTCOLOR	Stain & Paint	95			

ESSENCE ADVANTAGE

BY MASTERBRAND

CABINETS FAST

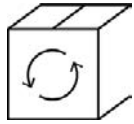

Cycle Ship

Orders are delivered based on a cycle ship calendar

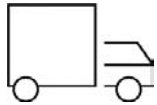

Truckload

15 business day lead time delivered

SERVICE MATTERS

As part of the Williams Distributing product family, we believe our service will set Essence Advantage apart. This is our pledge to every partner.



Consistent Support

We will be there to help before, during and after the sale.

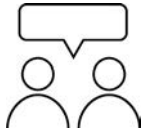

Personal Support

We will actually listen and work together to support your unique needs.



Proven Commitment

We will use our extensive knowledge and years of experience to help every partner success.

QUALITY ABOVE

We strive to deliver beyond your expectations. That's why popular features like all-plywood construction and soft-close come standard with every Essence Advantage cabinet. Say goodbye to the hassle of upgrades and added costs for your customers.

ESSENCE ADVANTAGE order

WAYS TO ORDER

1. Email orders to williamsorders@wmsdist.com
2. Fax orders to 616-456-8091
3. Call in orders 800-748-0503

CUSTOMER SERVICE HOURS

Monday - Friday 8:00 am - 5:00 pm EST

- Once we receive your order, we will contact you if there are any questions or concerns regarding your order.
- If there are no questions, your order will be entered and you will receive an Order Acknowledgment within 24 hours.
- Thoroughly review the Order Acknowledgment for accuracy including quantity, colors, etc.
- Please reference your Order Acknowledgment number when contacting us regarding your order.

Before placing your order, please review for accuracy. No changes can be made after submission to Masterbrand.



CLASSIC

Partial Overlay • Shaker • 2 1/4" Rail • Slab drawer front

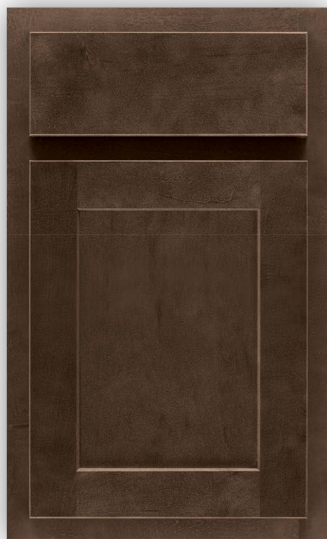

Bark

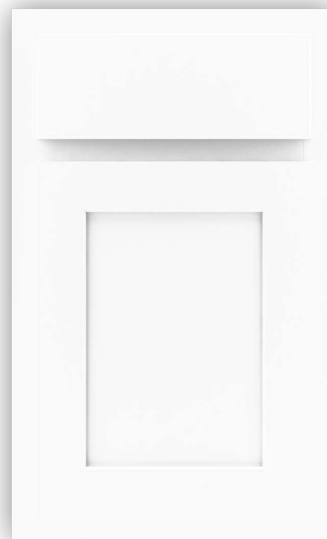

Snow



OMNI

Full Overlay • Shaker • 2 1/4" Rail • 5-piece drawer front



Admiral



Beachwood



Graphite

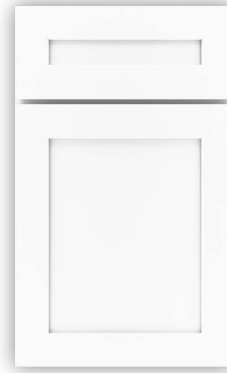

Snow



SPECTRA

Full Overlay • Transitional • 3" Rail • 5-piece drawer front

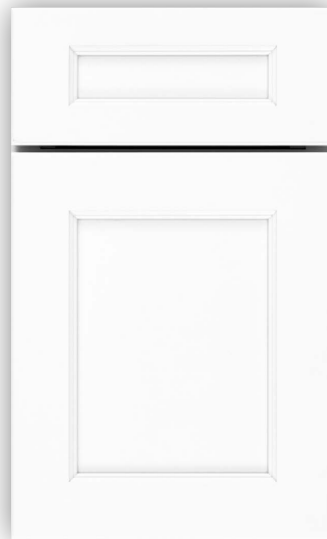

Snow

PRODUCT SPECIFICATIONS

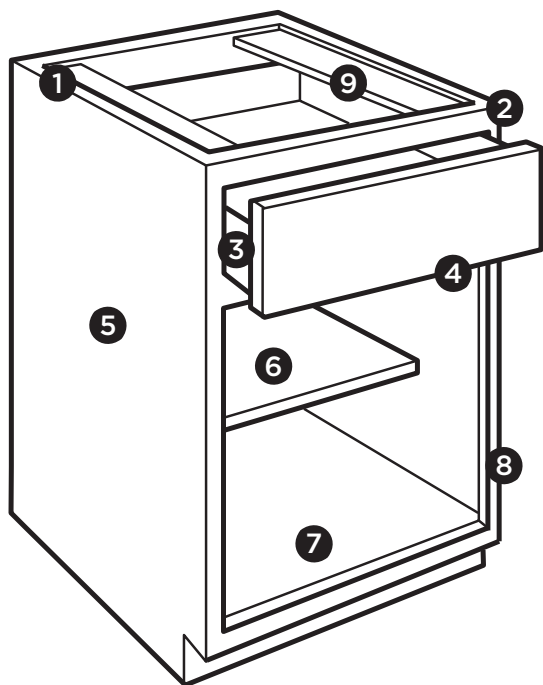









- 1 1/2" Plywood ends, 3/8" top, back, and bottom
- 2 3/4" Hardwood frame, doors and drawer fronts
- 3 5/8" Solid wood dovetail drawer box
- 4 Soft-closing, undermount, full extension drawer guides
- 5 Matching exterior
- 6 3/4" Natural Plywood adjustable shelves
- 7 Natural interior
- 8 Soft-closing, 6-way adjustable hinges
- 9 3/8" Plywood I-beam braces

Cabinet Care and Cleaning Instructions: [wmsdist.com/essence-advantage/resources](https://www.wmsdist.com/essence-advantage/resources)

For installation and warranty information, visit: [wmsdist.com/essence-advantage/resources](https://www.wmsdist.com/essence-advantage/resources)

PRICE AND STYLE CODE INFORMATION

	Price Group 1		Price Group 2					Price Group 3
	Classic Stain	Classic Paint	Omni Paint	Omni Paint	Omni Paint	Omni Stain	Omni Paint	Spectra Paint
	Bark	Snow	Snow	Mineral	Graphite	Beachwood	Admiral	Snow
								
Style Code	320	321	323	327	328	329	330	325
Common Style Code -Items with stain/paint price (Ex. Moulding)	310	311	311	312	313	314	315	311
Miscellaneous Code -Items with one price (Ex. Roll Trays)	300	300	300	300	300	300	300	300

NOTES

FULL AND PARTIAL OVERLAY SPECIFICATIONS

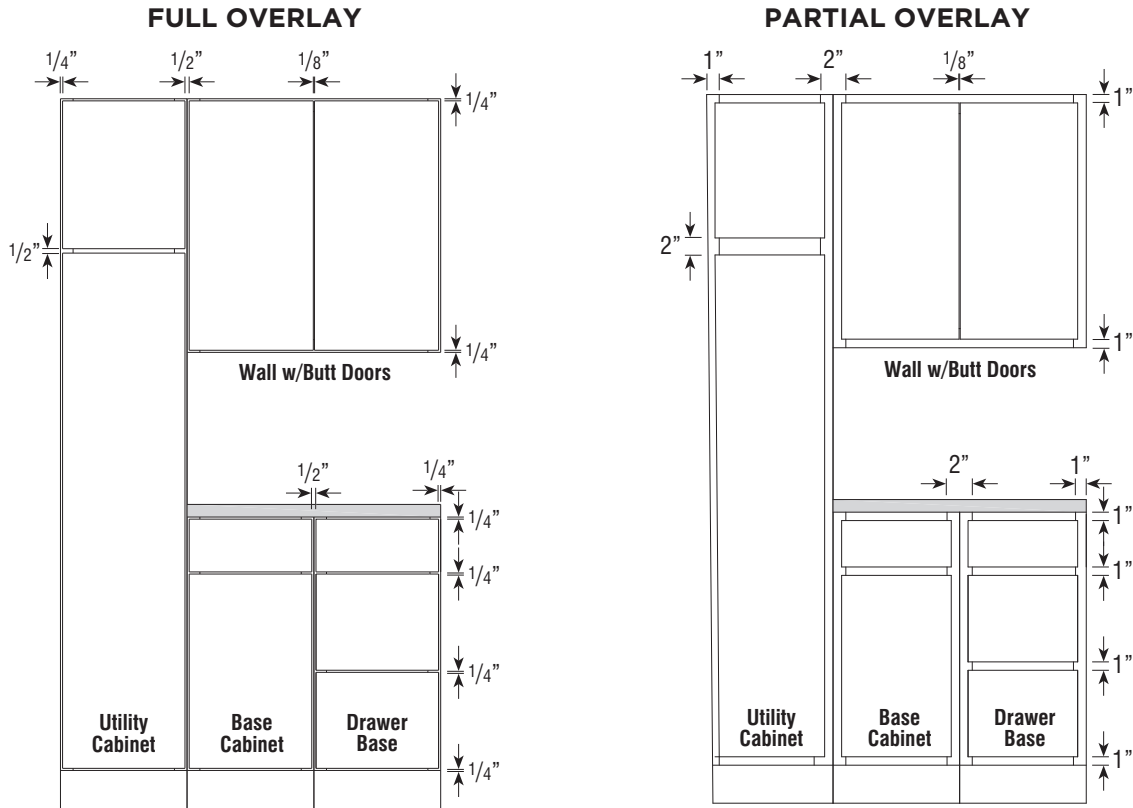

CABINET DIMENSIONS

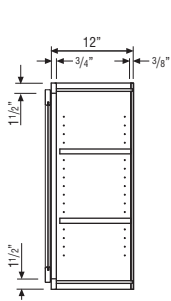

WALL CABINET

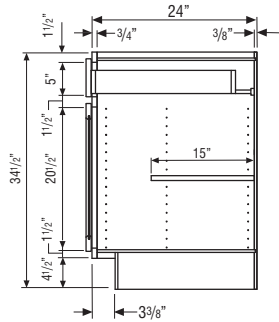

BASE CABINET

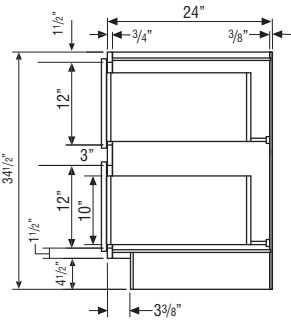

**TWO-DRAWER
BASE CABINET**

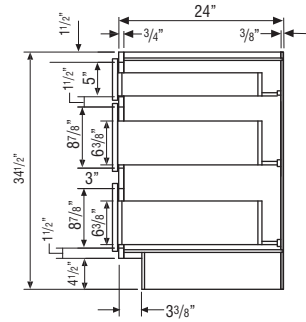

**THREE-DRAWER
BASE CABINET**

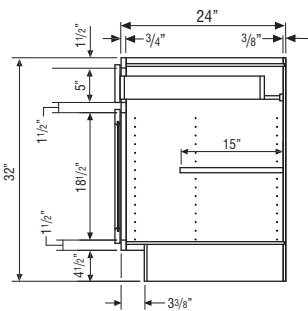

**32 1/2" HIGH
BASE CABINET**

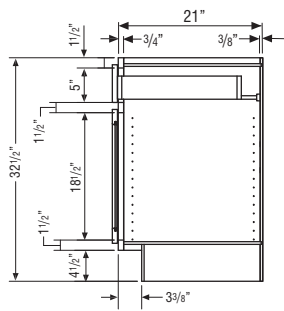

**32 1/2" HIGH
VANITY CABINET**

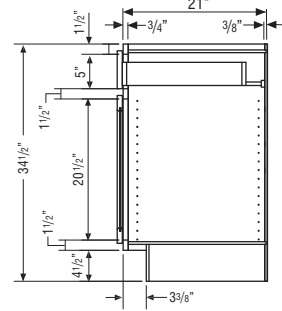

**34 1/2" HIGH
VANITY CABINET**

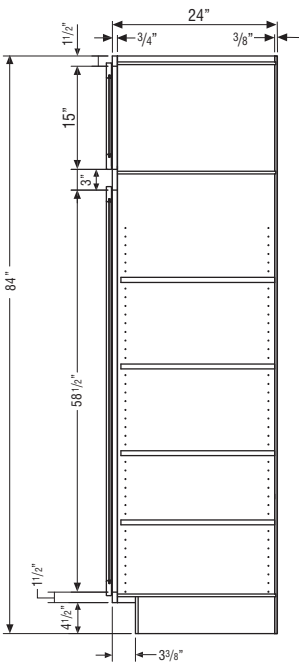

UTILITY CABINET

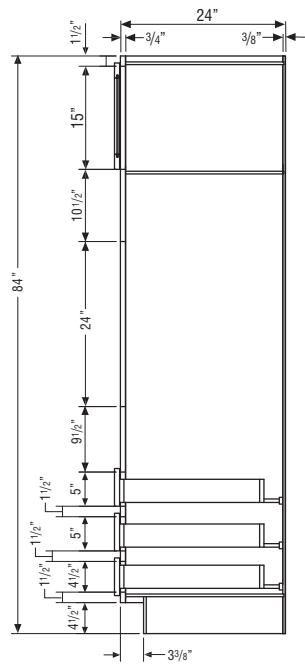

OC3D CABINET

CABINET DIMENSIONS

84" HIGH APPLICATION

Number after Wall Cabinet Represents Height of Cabinet

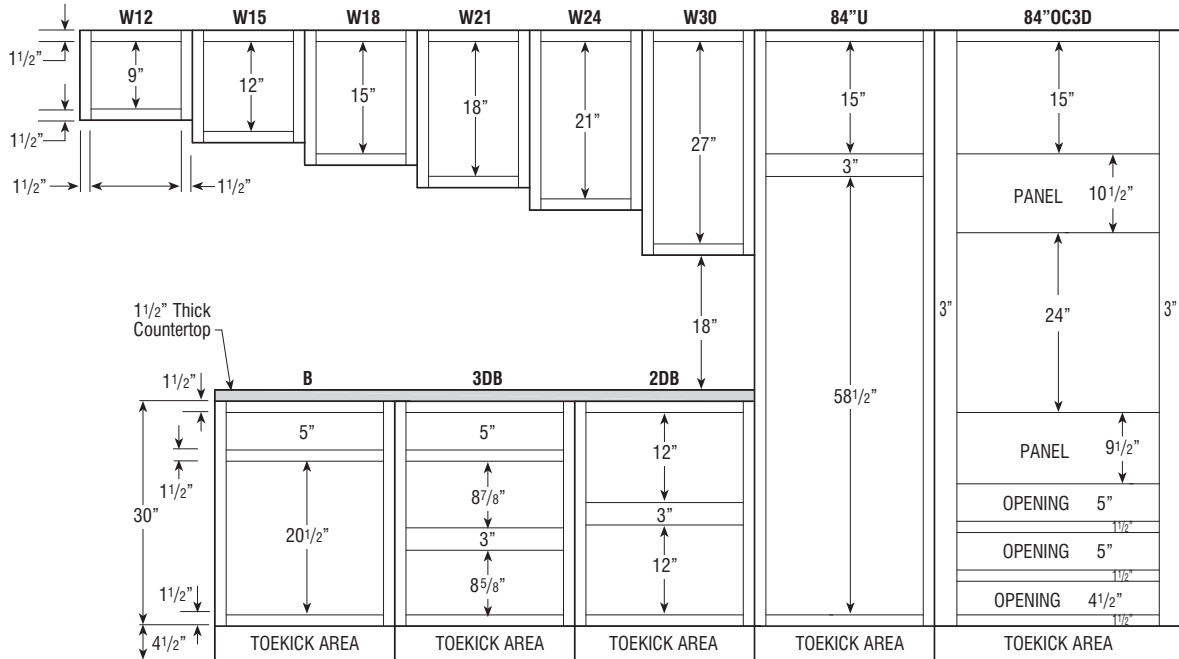

90" HIGH APPLICATION

Number after Wall Cabinet Represents Height of Cabinet

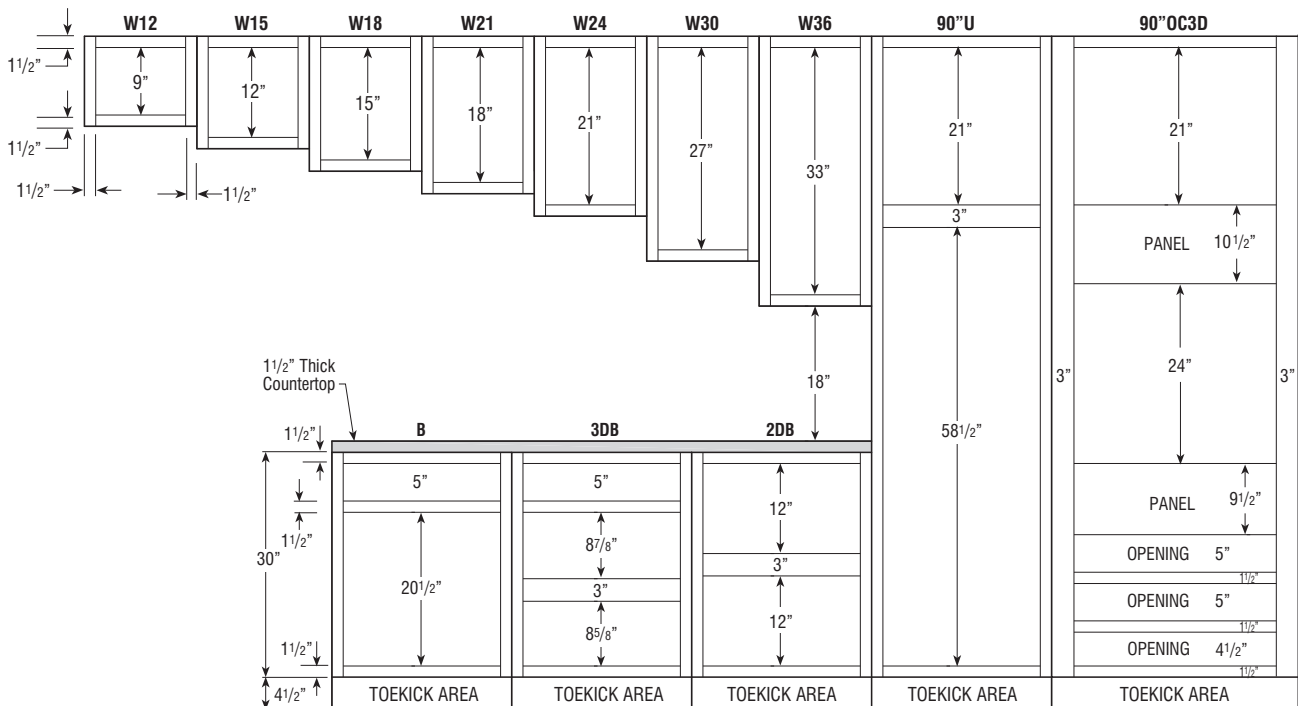

CABINET DIMENSIONS

93" HIGH APPLICATION

Number after Wall Cabinet Represents Height of Cabinet

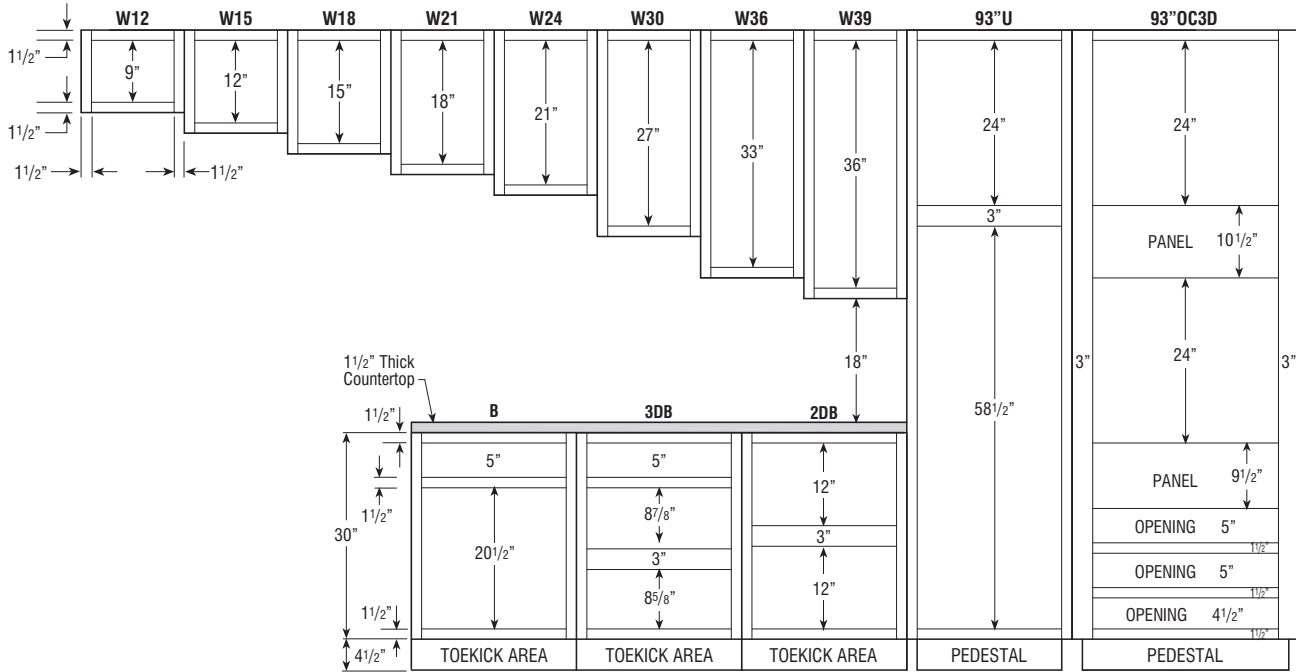

96" HIGH APPLICATION

Number after Wall Cabinet Represents Height of Cabinet

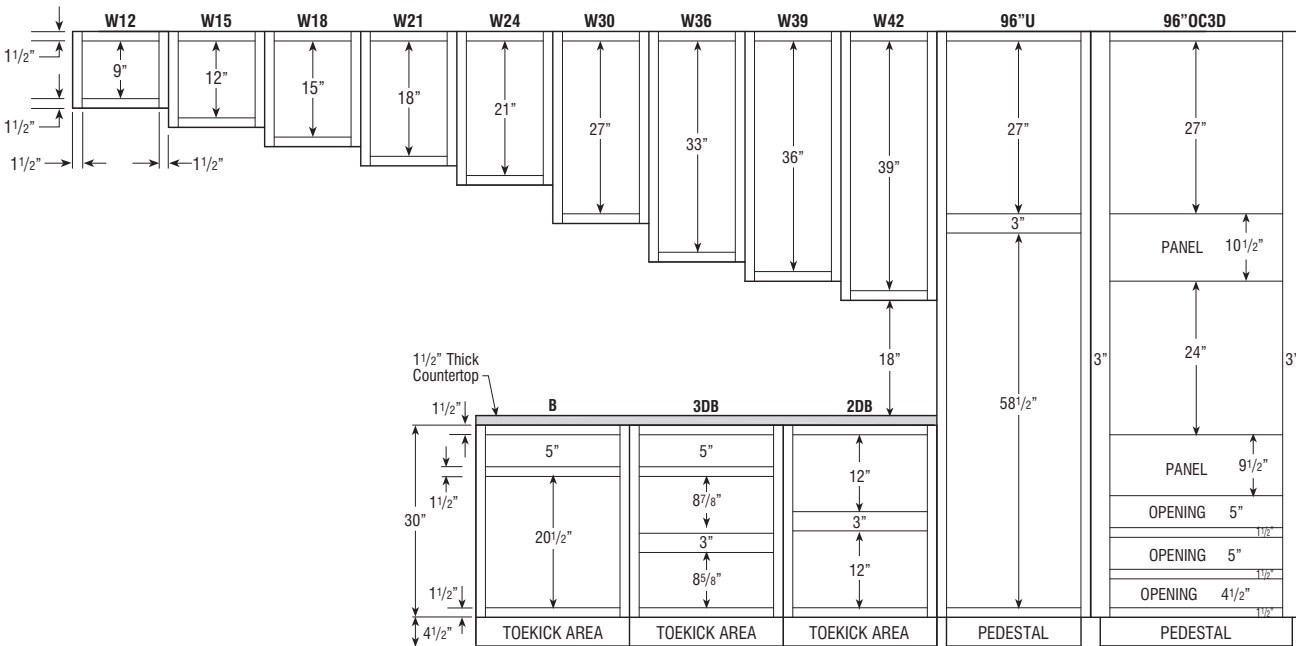

CABINET DIMENSIONS

32 1/2" HIGH BASE CABINETS

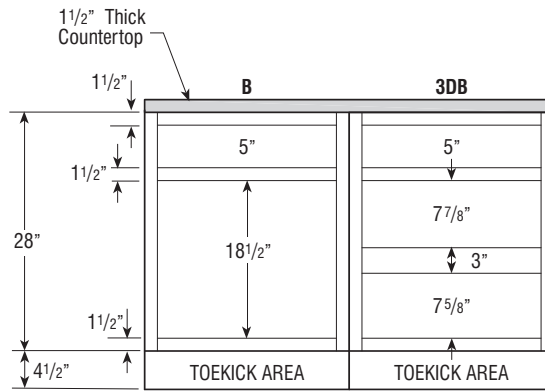

32 1/2" HIGH VANITY CABINETS

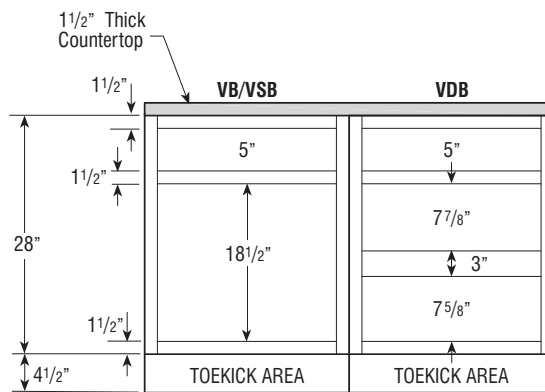

34 1/2" HIGH VANITY CABINETS

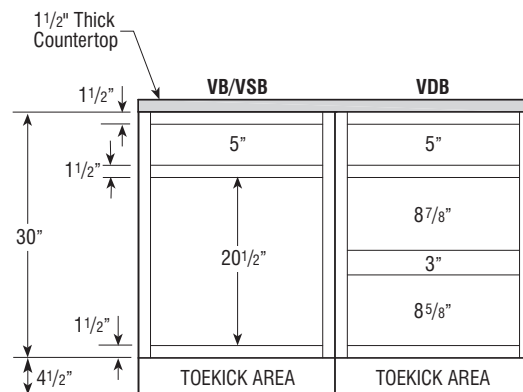

TABLE OF CONTENTS - WALL CABINETS



12" Deep Wall

12" High19
15" High19
18" High20
21" High20
24" High21
30" High22
36" High24
39" High26
42" High28

12" Deep Wall Cut-for-glass

30" High30
36" High31
42" High32

24" Deep Wall

12" High33
18" High34
21" High34
24" High35

24" Deep Microwave Wall Cabinet

18" High35
----------------	-----

12" Deep Wall Corner

30" High36
36" High37
39" High38
42" High38

12" Deep Diagonal Wall

30" High39
36" High39
39" High39
42" High39

12" Deep Diagonal Wall Cut-for-glass

30" High40
36" High40
42" High40

12" Deep Easy Reach Wall Corner

30" High41
36" High41

WALL DOUBLE DOOR

12" High

12" Deep

Model	Cubic Feet	1	2	3
W3012	3.4	224	265	305
W3312	3.7	257	303	348
W3612	4.0	297	351	405

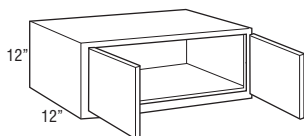

WALL DOUBLE DOOR

15" High

12" Deep

Model	Cubic Feet	1	2	3
W2415	3.2	295	348	400
W3015	3.9	268	317	361
W3315	4.2	292	345	400
W3615	4.6	320	376	433

• W2415 not available in Classic Bark.

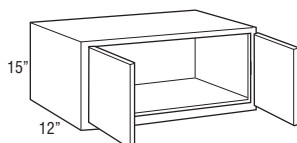

WALL DOUBLE DOOR

18" High

12" Deep

Model	Cubic Feet	1	2	3
W2418	3.8	303	355	411
W3018	4.9	320	376	433
W3318	5.3	335	393	453
W3618	5.8	343	402	461

• W2418 not available in Classic Bark.

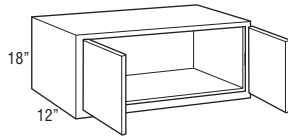

WALL DOUBLE DOOR

21" High

12" Deep

Model	Cubic Feet	1	2	3
W3021	6.7	338	397	459
W3621	8.0	372	435	499

• Not available in Classic Bark.

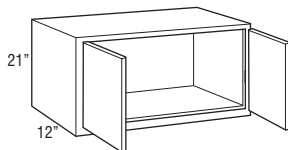

WALL SINGLE DOOR

24" High

12" Deep

Model	Cubic Feet	1	2	3
W2124R	4.6	297	351	405

- Cabinet hinged on the right; may be flipped for left hinge application.

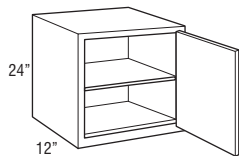

WALL DOUBLE DOOR

24" High

12" Deep

Model	Cubic Feet	1	2	3
W2424	5.2	323	379	437
W3024	6.4	357	418	484
W3324	7.0	382	450	516
W3624	7.6	400	468	536

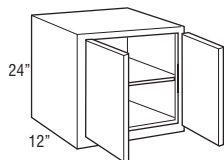

WALL SINGLE DOOR

30" High

12" Deep

Model	Cubic Feet	1	2	3
W930R	2.6	253	292	335
W1230R	3.4	257	305	351
W1530R	4.1	271	323	376
W1830R	4.9	295	348	402
W2130R	5.6	320	376	433

• Cabinet hinged on the right; may be flipped for left hinge application.

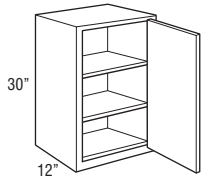

WALL DOUBLE DOOR

30" High

12" Deep

Model	Cubic Feet	1	2	3
W2430	6.4	348	411	468
W2730	7.2	385	453	526
W3030	7.9	402	471	538
W3330	8.7	442	521	595
W3630	9.4	457	536	616
W4230	11.0	501	591	680

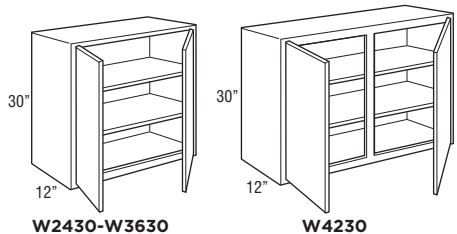

WALL SINGLE DOOR

36" High

12" Deep

Model	Cubic Feet	1	2	3
W936R	3.1	289	335	389
W1236R	4.0	303	353	411
W1536R	4.9	314	373	423
W1836R	5.8	343	402	461
W2136R	6.7	373	437	501

- Cabinet hinged on the right; may be flipped for left hinge application.

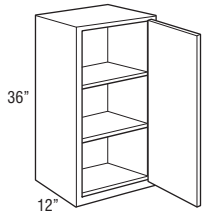

WALL DOUBLE DOOR

36" High

12" Deep

Model	Cubic Feet	1	2	3
W2436	7.6	405	477	551
W2736	8.5	447	526	604
W3036	9.4	464	548	631
W3336	10.3	516	604	689
W3636	11.2	533	621	717
W4236	13.1	595	698	804

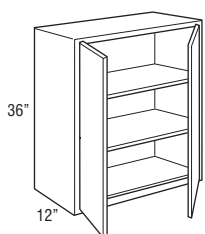

W2436-W3636

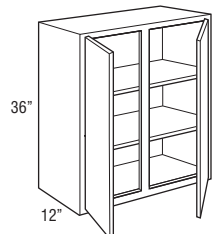

W4236

WALL SINGLE DOOR

39" High

12" Deep

Model	Cubic Feet	1	2	3
W939R	3.3	303	346	400
W1239R	4.3	318	364	418
W1539R	5.3	335	384	440
W1839R	6.3	361	414	477
W2139R	7.3	392	450	520

- Cabinet hinged on the right; may be flipped for left hinge application.
- Not available in Classic Bark.

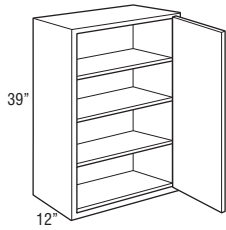

WALL DOUBLE DOOR

39" High

12" Deep

Model	Cubic Feet	1	2	3
W2439	8.2	425	487	561
W2739	9.2	470	539	620
W3039	10.2	491	563	648
W3339	11.2	543	621	713
W3639	12.1	559	640	735
W4239	14.1	623	717	826

• Not available in Classic Bark.

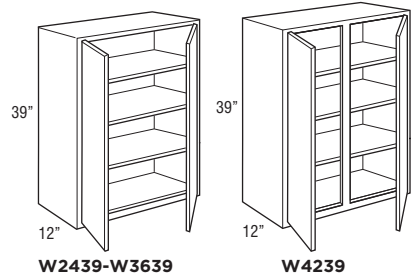

WALL SINGLE DOOR

42" High

12" Deep

Model	Cubic Feet	1	2	3
W942R	3.6	326	382	440
W1242R	4.6	343	402	461
W1542R	5.7	365	425	492
W1842R	6.7	389	457	531
W2142R	7.8	423	499	572

- Cabinet hinged on the right; may be flipped for left hinge application.

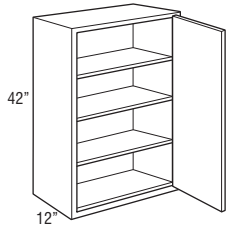

WALL DOUBLE DOOR

42" High

12" Deep

Model	Cubic Feet	1	2	3
W2442	8.8	457	536	616
W2742	9.9	504	595	683
W3042	11.0	533	621	717
W3342	12.0	586	685	791
W3642	13.1	600	708	811
W4242	15.2	670	791	912

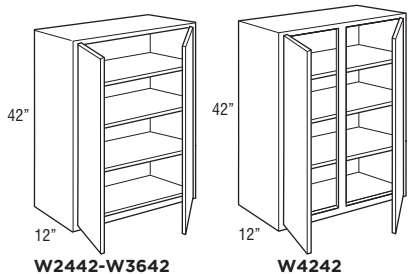

WALL CUT-FOR-GLASS CABINETS

RECOMMENDED GLASS SIZE FOR WALL CABINET DOORS			
SKU	Omni Door Size	Door Route Size	Glass Size
WCG1530R	14 1/2" x 29 1/2"	11 1/4" x 26 1/4"	11 1/16" x 26 1/16"
WCG1830R	17 1/2" x 29 1/2"	14 1/4" x 26 1/4"	14 1/16" x 26 1/16"
WCG3030	14 11/16" x 29 1/2"	11 7/16" x 26 1/4"	11 1/4" x 26 1/16"
WCG3630	17 11/16" x 29 1/2"	14 7/16" x 26 1/4"	14 1/4" x 26 1/16"
WCG1536R	14 1/2" x 35 1/2"	11 1/4" x 32 1/4"	11 1/16" x 32 1/16"
WCG1836R	17 1/2" x 35 1/2"	14 1/4" x 32 1/4"	14 1/16" x 32 1/16"
WCG3036	14 11/16" x 35 1/2"	11 7/16" x 32 1/4"	11 1/4" x 32 1/16"
WCG3636	17 11/16" x 35 1/2"	14 7/16" x 32 1/4"	14 1/4" x 32 1/16"
WCG1542R	14 1/2" x 41 1/2"	11 1/4" x 38 1/4"	11 1/16" x 38 1/16"
WCG1842R	17 1/2" x 41 1/2"	14 1/4" x 38 1/4"	14 1/16" x 38 1/16"
WCG3042	14 11/16" x 41 1/2"	11 7/16" x 38 1/4"	11 1/4" x 38 1/16"
WCG3642	17 11/16" x 41 1/2"	14 7/16" x 38 1/4"	14 1/4" x 38 1/16"

*Recommended glass size dimensions are 3/16" smaller than glass route.

WALL CUT-FOR-GLASS

30" High

12" Deep

Model	Cubic Feet	1	2	3
WCG1530R	4.1	•	363	•
WCG1830R	4.9	•	386	•

- Cabinet hinged on the right; may be flipped for left hinge application.
- Glass clips included with door; glass not included.
- Cabinets will have matching interior.

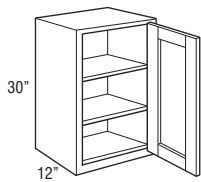

WALL CUT-FOR-GLASS

30" High

12" Deep

Model	Cubic Feet	1	2	3
WCG3030	7.9	•	558	•
WCG3630	9.4	•	620	•

- Glass clips included with door; glass not included.
- Cabinets will have matching interior.

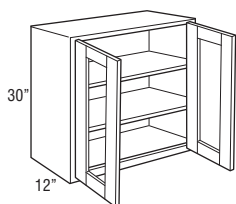

WALL CUT-FOR-GLASS

36" High

12" Deep

Model	Cubic Feet	1	2	3
WCG1536R	4.9	•	411	•
WCG1836R	5.8	•	440	•

- Cabinet hinged on the right; may be flipped for left hinge application.
- Glass clips included with door; glass not included.
- Cabinets will have matching interior.

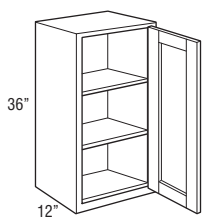

WALL CUT-FOR-GLASS

36" High

12" Deep

Model	Cubic Feet	1	2	3
WCG3036	9.4	•	631	•
WCG3636	11.2	•	702	•

- Glass clips included with door; glass not included.
- Cabinets will have matching interior.

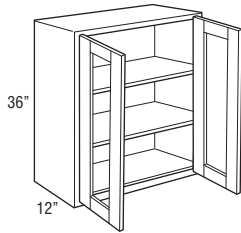

WALL CUT-FOR-GLASS

42" High

12" Deep

Model	Cubic Feet	1	2	3
WCG1542R	5.7	•	461	•
WCG1842R	6.7	•	492	•

- Cabinet hinged on the right; may be flipped for left hinge application.
- Glass clips included with door; glass not included.
- Cabinets will have matching interior.

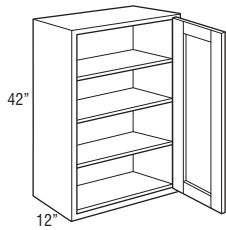

WALL CUT-FOR-GLASS

42" High

12" Deep

Model	Cubic Feet	1	2	3
WCG3042	11.0	•	702	•
WCG3642	13.0	•	787	•

- Glass clips included with door; glass not included.
- Cabinets will have matching interior.

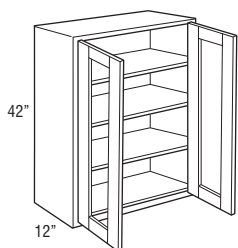

WALL DOUBLE DOOR

12" High

24" Deep

Model	Cubic Feet	1	2	3
W361224	7.4	361	423	490

- 24" deep cabinets must be supported on three surfaces when mounted.
- Load limit is 15 lbs. per square foot of load bearing surface.

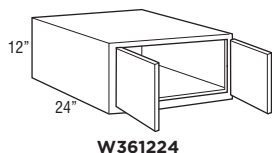

WALL DOUBLE DOOR

18" High 24" Deep

Model	Cubic Feet	1	2	3
W361824	10.7	391	461	533
W391824	11.5	411	481	553

- 24" deep cabinets must be supported on three surfaces when mounted.
- Load limit is 15 lbs. per square foot of load bearing surface.

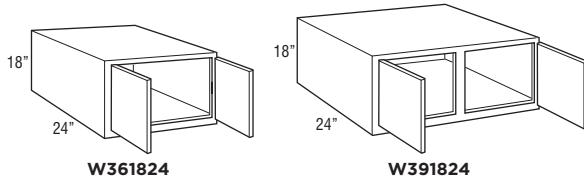

WALL DOUBLE DOOR

21" High 24" Deep

Model	Cubic Feet	1	2	3
W362124	13.5	419	494	569

- 24" deep cabinets must be supported on three surfaces when mounted.
- Load limit is 15 lbs. per square foot of load bearing surface.
- Not available in Classic Bark.

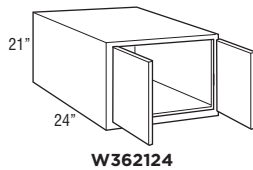

WALL DOUBLE DOOR

24" High

24" Deep

Model	Cubic Feet	1	2	3
W362424	14.0	447	526	604

- 24" deep cabinets must be supported on three surfaces when mounted.
- Load limit is 15 lbs. per square foot of load bearing surface.

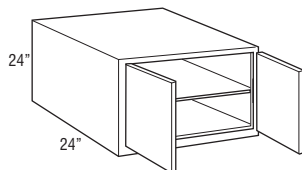

W362424

MICROWAVE WALL CABINET

18" High

24" Deep

Model	Cubic Feet	1	2	3
MW3018	4.9	414	414	414

- Includes one 3/4" shelf with six mounting screws. Microwave shelf extends beyond the front of the cabinet by 6 1/2", for a total shelf depth of 18 1/2".
- Microwave cabinet must be attached to wall stud and adjacent cabinets on both sides for support.
- Finished matching interior.

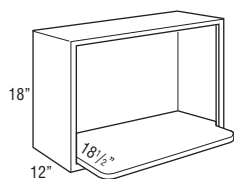

Model	Opening Width	Opening Height
MW3018	27"	14 1/2"

WALL CORNER CABINETS

SKU	A	B	C	D	E		E		F
	Min. Space	Max. Pull	Max. Space	Cabinet Opening	Full Overlay At Min.	Full Overlay At Max.	Partial Overlay At Min.	Partial Overlay At Max.	Actual Cabinet
WC30...	30"	5"	35"	13 1/2"	1 3/4"	6 3/4"	2 1/2"	7 1/2"	30"
WC36...	36"	5"	41"	19 1/2"	1 3/4"	6 3/4"	2 1/2"	7 1/2"	36"
WC42...	42"	4 1/2"	46 1/2"	24"	3 1/4"	7 3/4"	4"	8 1/2"	42"

- Wall corner cabinets may be installed flush to the wall (left) or pulled 3" away from wall (right) to accommodate add dimensions in a kitchen design. In either case, the adjoining run of 12" wall cabinets plus a 3" filler will butt against the solid-wood panel.
- When a cabinet is "pulled" it will use proportionally more space, for example, a 30" wide WC, pulled 2" will use 32" of space.
- Blind side of wall corner cabinets cannot be installed next to a range hood unit due to door interference.

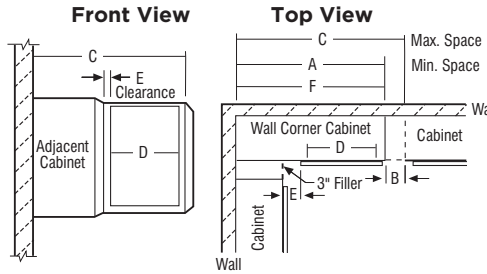

NOTE:
All outside stiles are 1 1/2" wide

WALL CORNER SINGLE DOOR

30" High

12" Deep

Model	Cubic Feet	1	2	3
WC3030S	7.9	348	411	468
WC3630S	9.4	385	453	521

- Right blind shown; cabinet may be flipped for left blind application.
- Filler required for installation. Must be ordered separately.

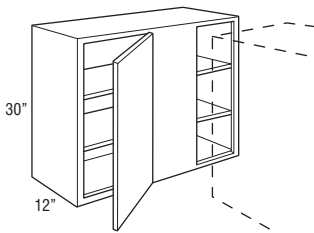

WALL CORNER DOUBLE DOOR

30" High

12" Deep

Model	Cubic Feet	1	2	3
WC4230S	11.0	447	526	604

- Right blind shown; cabinet may be flipped for left blind application.
- Filler required for installation. Must be ordered separately.

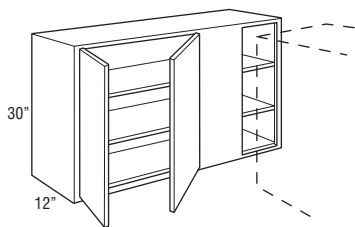

WALL CORNER SINGLE DOOR

36" High

12" Deep

Model	Cubic Feet	1	2	3
WC3036S	9.4	418	495	570
WC3636S	11.2	457	536	616

- Right blind shown; cabinet may be flipped for left blind application.
- Filler required for installation. Must be ordered separately.

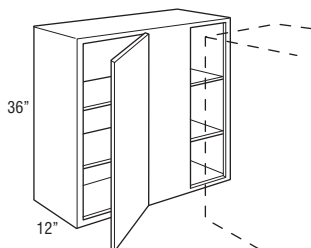

WALL CORNER SINGLE DOOR

39" High

12" Deep

Model	Cubic Feet	1	2	3
WC3039S	10.2	447	513	594
WC3639S	12.1	492	560	642

- Right blind shown; cabinet may be flipped for left blind application.
- Filler required for installation. Must be ordered separately.
- Not available in Classic Bark.

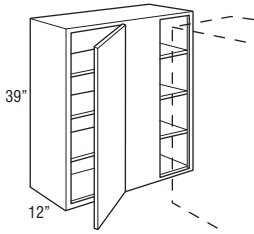

WALL CORNER SINGLE DOOR

42" High

12" Deep

Model	Cubic Feet	1	2	3
WC3042S	11.0	471	553	640
WC3642S	13.1	516	604	689

- Right blind shown; cabinet may be flipped for left blind application.
- Filler required for installation. Must be ordered separately.

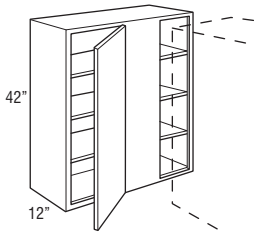

DIAGONAL WALL

30" High

36" High

12" Deep

Model	Cubic Feet	1	2	3
DW302424R	10.8	402	471	538
DW362424R	12.9	481	570	653

- Cabinet hinged on the right; may be flipped for left hinge application.
- Cabinets require 24" x 24" of corner wall space.

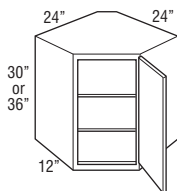

DIAGONAL WALL

39" High

42" High

12" Deep

Model	Cubic Feet	1	2	3
DW392424R	13.9	553	655	750
DW422424R	14.9	581	683	788

- Cabinet hinged on the right; may be flipped for left hinge application.
- Cabinets require 24" x 24" of corner wall space.
- DW392424R not available in Classic Bark.

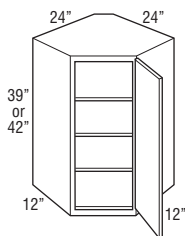

DIAGONAL WALL CUT-FOR-GLASS CABINETS

RECOMMENDED GLASS SIZE FOR WALL CABINET DOORS			
SKU	Omni Door Size	Door Route Size	Glass Size
DWCG302424R	14 1/2" x 29 1/2"	11 1/4" x 26 1/4"	11 1/16" x 26 1/16"
DWCG362424R	14 1/2" x 35 1/2"	11 1/4" x 32 1/4"	11 1/16" x 32 1/16"
DWCG422424R	14 1/2" x 41 1/2"	11 1/4" x 38 1/4"	11 1/16" x 38 1/16"

*Recommended glass size dimensions are 3/16" smaller than glass route.

DIAGONAL WALL CUT-FOR-GLASS

30" High

36" High

12" Deep

Model	Cubic Feet	1	2	3
DWCG302424R	10.8	•	558	•
DWCG362424R	12.9	•	653	•

- Cabinet hinged on the right; may be flipped for left hinge application.
- Cabinets require 24" x 24" of corner wall space.
- Glass clips included with door; glass not included.
- Cabinets will have matching interior.

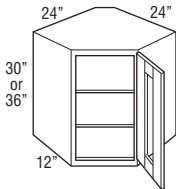

DIAGONAL WALL CUT-FOR-GLASS

42" High

12" Deep

Model	Cubic Feet	1	2	3
DWCG422424R	14.9	•	763	•

- Cabinet hinged on the right; may be flipped for left hinge application.
- Cabinets require 24" x 24" of corner wall space.
- Glass clips included with door; glass not included.
- Cabinets will have matching interior.

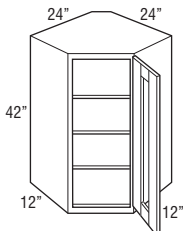

EASY REACH WALL CORNER

30" High

36" High

12" Deep

Model	Cubic Feet	1	2	3
ER30R	12.3	510	598	684
ER36R	14.6	613	725	831

- Requires 24" x 24" of corner wall space.
- Adjustable shelves.
- Cabinet hinged on the right; may be flipped for left hinge application.
- Hinged door opens 170°.
- Integrated soft-close hinge not included.

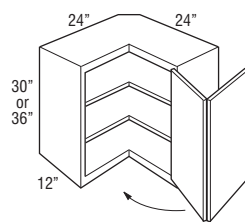

TABLE OF CONTENTS - BASE CABINETS



34 1/2" High, 24" Deep

Base with Drawer43

Full Height Base44

Drawer Base45

Base Built-in Microwave Cabinet with Drawer47

Base Wastebasket47

Sink Base48

Base Corner50

BASE SINGLE DOOR

34 1/2" High

24" Deep

Model	Cubic Feet	1	2	3
B9R	5.4	297	351	405
B12R	7.1	323	379	437
B15R	8.7	348	411	468
B18R	10.3	376	442	508
B21R	11.7	405	477	551

- Cabinet hinged on the right; door may be flipped for left hinge application.
- Roll tray kits available for 15"-21" widths.

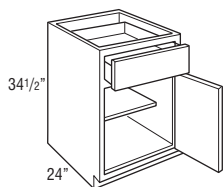

BASE DOUBLE DOOR

34 1/2" High

24" Deep

Model	Cubic Feet	1	2	3
B24	13.3	468	551	637
B27	14.9	504	595	683
B30	16.5	540	643	735
B33	18.1	588	689	793
B36	19.6	637	745	859
B42	22.8	685	806	927

• Roll tray kits available for 24"-42" widths.

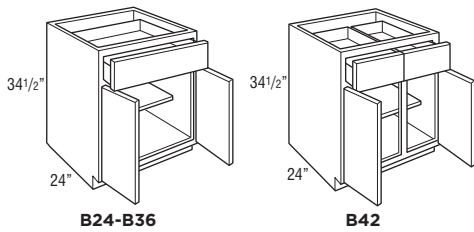

FULL HEIGHT BASE SINGLE DOOR

34 1/2" High

24" Deep

Model	Cubic Feet	1	2	3
B9FHR	5.4	291	343	393
B12FHR <small>new</small>	7.1	292	344	396
B15FHR	8.5	292	345	400
B18FHR	10.1	314	373	423

• Cabinet hinged on the right; door may be flipped for left hinge application.
 • Roll tray kits available for 15"-18" widths.

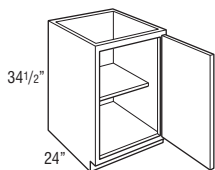

FULL HEIGHT BASE DOUBLE DOOR

34½" High

24" Deep

Model	Cubic Feet	1	2	3
B24FH	13.3	385	453	521
B30FH	16.5	447	526	604
B36FH	19.6	477	560	646

• Roll tray kits available for 24"-36" widths.

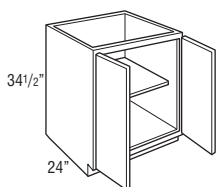

2 DRAWER BASE

34½" High

24" Deep

Model	Cubic Feet	1	2	3
2DB30	16.5	710	838	965
2DB36	19.6	778	916	1053

• On door styles with slab drawer fronts, all drawer fronts will be slab.

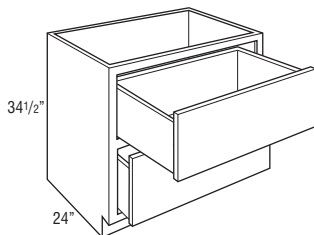

3 DRAWER BASE

34 1/2" High

24" Deep

Model	Cubic Feet	1	2	3
3DB12	7.0	453	533	612
3DB15	8.5	495	581	668
3DB18	10.1	538	640	733
3DB21	11.7	595	698	804
3DB24	13.3	653	766	881
3DB27 new	14.9	682	802	923
3DB30	16.5	710	838	965
3DB33 new	18.1	744	878	1009
3DB36	19.6	778	916	1053

• On door styles with slab drawer fronts, all drawer fronts will be slab.

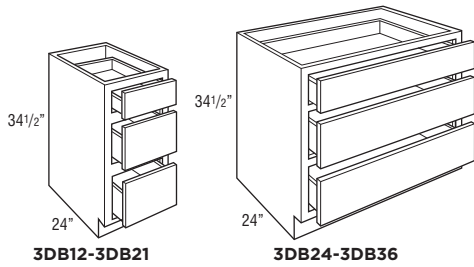

BASE BUILT-IN MICROWAVE WITH DRAWER

34 1/2" High

24" Deep

Model	Cubic Feet	1	2	3
BBMWD30	16.1	679	803	920

- The usable cabinet face height between top of drawer front and top of cabinet is 19 1/8" for partial overlay and 19 3/4" for full overlay. Be sure to verify overall appliance height, gap requirements, and cut-out dimensions with cabinet specifications.
- Metal appliance support brackets included.

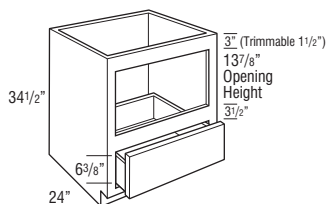

Model	Opening Width	Maximum Width	Opening Height	Maximum Height
BBMWD30	27"	28 1/2"	13 7/8"	16 7/8"

BASE WASTEBASKET

34 1/2" High

24" Deep

Model	Cubic Feet	1	2	3
BWB18	10.3	616	729	838

- Pull-out features undermount full extension, soft-close guides.
- Includes two 35 quart gray wastebaskets.

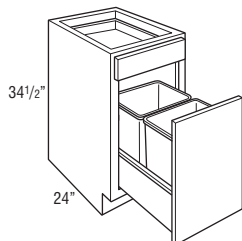

SINK BASE

34 1/2" High

24" Deep

Model	Cubic Feet	1	2	3
SB24	13.3	365	425	492
SB27	14.9	385	453	526
SB30	16.5	405	473	540
SB33	18.1	442	523	600
SB36	19.6	464	548	631
SB42	22.8	492	576	664

- Mini Touch-Up Kit (MTUK) included. MTUK includes small touch-up marker and small fill stick.
- Tilt-out tray kits available.

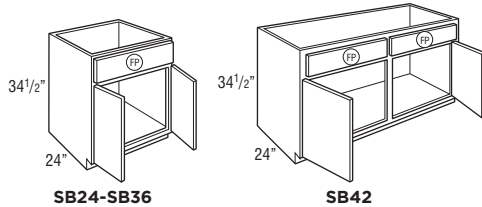

COUNTRY SINK BASE

34 1/2" High

24" Deep

Model	Cubic Feet	1	2	3
CNTYSB36	19.6	581	683	788

- 13 1/2" panel can be trimmed up to 12".
- Mini Touch-Up Kit (MTUK) included. MTUK includes small touch-up marker and small fill stick.
- Refer to manufacturer's recommendations for additional support required for apron front sinks.

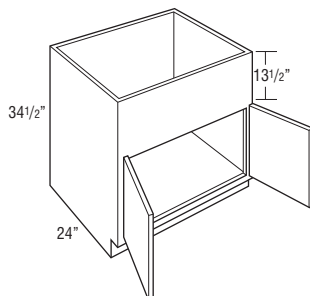

ANGLED CORNER SINK FRONT 34 1/2" High

Model	Cubic Feet	1	2	3
ACSF36R	2.9	292	345	400

- Frame edges beveled at 45°.
- Toekick and toekick retainer shipped unattached from the face frame.
- Sink base floor not included.
- Cabinet hinged on the right; door may be flipped for left hinge application.

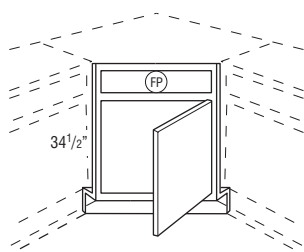

Max. Sink Widths if cut-out is 4" back from face of front frame

Wall Width	Frame	Maximum Sink Width	Maximum Sink Depth
36" x 36"	17"	25 3/4"	27 11/32"

ANGLED CORNER SINK FRONT BOTTOM

Model	Cubic Feet	1	2	3
ACSFB36	1.0	157	157	157

- Designed for use with Angled Corner Sink Front.
- 3/4" thick.
- 1-side laminated plywood.



BASE CORNER CABINETS

SKU	A Min. Space	B Max. Pull	C Max. Space	D Cabinet Opening	E Full Overlay		E Partial Overlay		F Actual Cabinet
					At Min.	At Max.	At Min.	At Max.	
BC36S	36"	6"	42"	7 1/2"	1 3/4"	7 3/4"	2 1/2"	8 1/2"	27"
BC42S	42"	6"	48"	13 1/2"	1 3/4"	7 3/4"	2 1/2"	8 1/2"	39"
BC48S	48"	3"	51"	16 1/2"	4 3/4"	7 3/4"	5 1/2"	8 1/2"	45"

- BCs use the wall space the nomenclature implies and may be pulled up to 3" to accommodate odd dimensions in a kitchen.
- Remember to use 3" filler on adjoining cabinets.
- The adjoining run of cabinets will cover the void.

NOTE:

Full overlay styles must be pulled an additional 1 1/2" to ensure proper drawer/pull clearance. 1 1/2" pull is not included in minimum and maximum list.

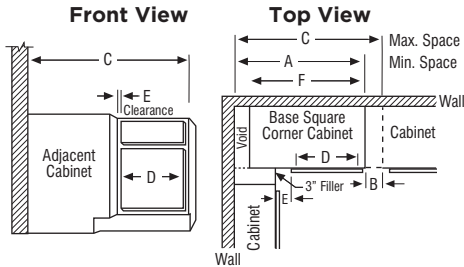

BASE CORNER SINGLE DOOR

34 1/2" High

24" Deep

Model	Cubic Feet	1	2	3
BC36S	15.0	442	523	600
BC42S	21.3	499	588	678
BC48S	24.5	581	683	788

- Right blind shown; door and drawer can be reversed for left blind application.
- Filler required for installation. Must be ordered separately.

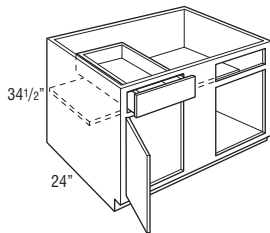

BASE EASY REACH

34 1/2" High

24" Deep

Model	Cubic Feet	1	2	3
BER33R	26.3	686	789	908
BER36R	29.1	733	861	994

- BER33R wall width is 33" x 33". BER36R wall width is 36" x 36".
- Decorative hardware screws must be countersunk to prevent scratching of adjacent cabinets and face frame of BER.
- Not recommended for use next to an appliance deeper than standard cabinet depth.
- Soft-close not available.
- Cabinet hinged on the right; door may be flipped for left hinge application.
- BER33R not available in Classic Bark.

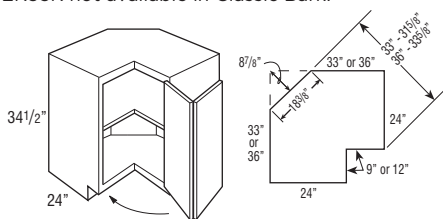

Due to the fixed shelves mounting shelves cannot be retrofitted.

SUPER LAZY SUSAN

34 1/2" High

24" Deep

Model	Cubic Feet	1	2	3
SLS36R	29.1	927	1087	1249

- Wall width is 36" x 36".
- Features two plywood revolving shelves. Lower shelf is mounted to floor. Upper shelf is mounted to fixed shelf.
- Decorative hardware screws must be countersunk to prevent scratching adjacent cabinets and face frame of SLS.
- Not recommended for use next to an appliance deeper than standard cabinet depth.
- Soft-close not available.
- Cabinet hinged on the right; door may be flipped for left hinge application.

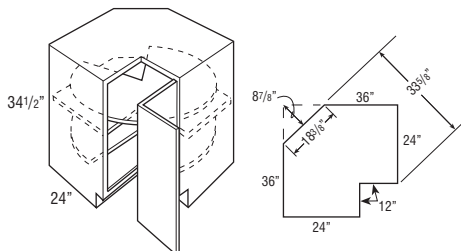

Due to the fixed shelves mounting shelves cannot be retrofitted.

BASE LAZY SUSAN

34 1/2" High

24" Deep

Model	Cubic Feet	1	2	3
BLS36R	20.4	659	776	889

- Wall width is 36" x 36".
- Cabinet is drum-shaped; adjoining cabinets create sides.
- Features two white plastic shelves.
- Decorative hardware screws must be countersunk to prevent scratching of adjacent cabinets and face frame of BLS.
- Not recommended for use next to an appliance deeper than standard cabinet depth.
- Soft-close not available.
- Cabinet hinged on the right; door may be flipped for left hinge application.
- Back material made from MDF.

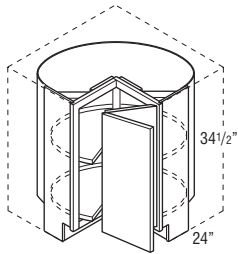
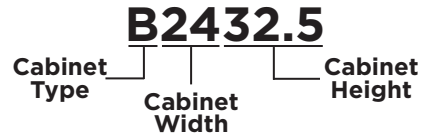

TABLE OF CONTENTS - UNIVERSAL DESIGN CABINETS



32 1/2" High, 24" Deep

Universal Design Base	54
Universal Design 3 Drawer Base	55
Universal Design Base Built-in Microwave Cabinet with Drawer	56
Universal Design Base Sink Removable	56
Universal Design Base Corner	57
Universal Design Super Lazy Susan	58
Universal Design Vanity Base Sink Removable	58

UNIVERSAL DESIGN, BASE SINGLE DOOR

32½" High

24" Deep

Model	Cubic Feet	1	2	3
B932.5R	5.0	•	351	•
B1232.5R	6.5	•	379	•
B1532.5R	8.0	•	411	•
B1832.5R	9.4	•	442	•
B2132.5R	10.9	•	477	•

- Cabinet hinged on the right; door may be flipped for left hinge application.
- Roll tray kits available for 15"-21" widths.
- Only available in Omni Snow.

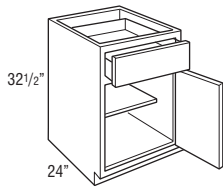

UNIVERSAL DESIGN, BASE DOUBLE DOOR

32 1/2" High

24" Deep

Model	Cubic Feet	1	2	3
B2432.5	12.4	•	551	•
B3032.5	15.3	•	643	•
B3332.5	16.8	•	689	•
B3632.5	18.3	•	745	•

- Roll tray kits available for 24"-36" widths.
- Only available in Omni Snow.

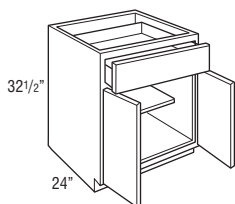

B2432.5-B3632.4

UNIVERSAL DESIGN, 3 DRAWER BASE

32 1/2" High

24" Deep

Model	Cubic Feet	1	2	3
3DB1232.5	6.3	•	533	•
3DB1532.5	8.0	•	581	•
3DB1832.5	9.4	•	640	•

- On door styles with slab drawer fronts, all drawer fronts will be slab.
- Only available in Omni Snow.

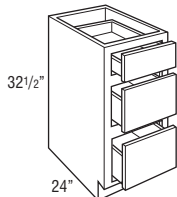

3DB1232.5-3DB1832.5

UNIVERSAL DESIGN, BASE BUILT-IN MICROWAVE WITH DRAWER

32 1/2" High

24" Deep

Model	Cubic Feet	1	2	3
BBMWD3032.5	15.3	•	763	•

- Matching Interior.
- Only available in Omni Snow.
- Metal appliance support brackets included.

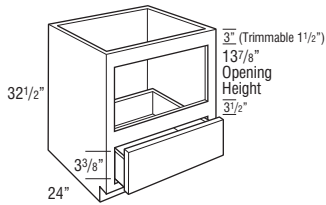

Model	Opening Width	Maximum Width	Opening Height	Maximum Height
BBMWD30	27"	28 1/2"	13 7/8"	16 7/8"

UNIVERSAL DESIGN, BASE SINK REMOVABLE

32 1/2" High

24" Deep

Model	Cubic Feet	1	2	3
BSR3032.5	13.7	•	389	•
BSR3332.5	14.9	•	400	•
BSR3632.5	16.4	•	411	•

- Cabinet must supported on both sides. Not intended for end of run.
- Front, cabinet bottom, and toekick are removable.
- Mini Touch-Up Kit (MTUK) included. MTUK includes small touch-up marker and small fill stick.
- Only available in Omni Snow.

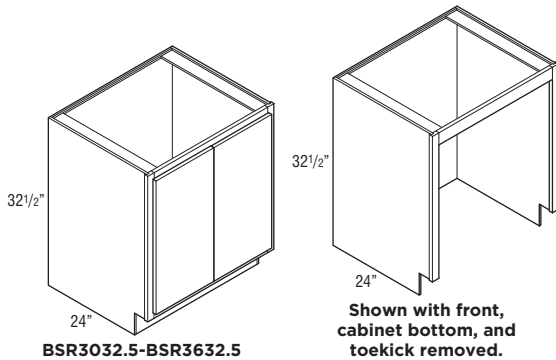

UNIVERSAL DESIGN CORNER CABINETS

SKU	A Min. Space	B Max. Pull	C Max. Space	D Cabinet Opening	E Full Overlay At Min. At Max.		E Partial Overlay At Min. At Max.		F Actual Cabinet
BC3632.5S	32"	6"	42"	7 1/2"	1 3/4"	7 3/4"	2 1/2"	8 1/2"	27"

- BCs use the wall space the nomenclature implies and may be pulled up to 3" to accommodate odd dimensions in a kitchen.
- Remember to use 3" filler on adjoining cabinets.
- The adjoining run of cabinets will cover the void.

NOTE:

Full overlay styles must be pulled an additional 1 1/2" to ensure proper drawer/pull clearance. 1 1/2" pull is not included in minimum and maximum list.

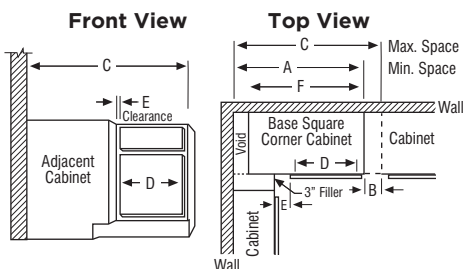

UNIVERSAL DESIGN, BASE CORNER SINGLE DOOR

32 1/2" High

24" Deep

Model	Cubic Feet	1	2	3
BC3632.5S	14.1	•	523	•

- Right blind shown; door and drawer can be reversed for left blind application.
- Filler required for installation. Must be ordered separately.
- Only available in Omni Snow.

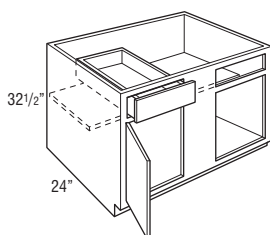

UNIVERSAL DESIGN, SUPER LAZY SUSAN

32 1/2" High

24" Deep

Model	Cubic Feet	1	2	3
SLS3632.5R	18.4	•	1087	•

- Wall width is 36" x 36".
- Features two plywood revolving shelves. Lower shelf is mounted to floor. Upper shelf is mounted to fixed shelf.
- Decorative hardware screws must be countersunk to prevent scratching adjacent cabinets and face frame of SLS.
- Not recommended for use next to an appliance deeper than standard cabinet depth.
- Soft-close not available.
- Cabinet hinged on the right; door may be flipped for left hinge application.
- Only available in Omni Snow.

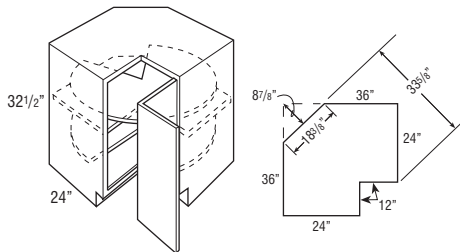

Due to the fixed shelves mounting shelves cannot be retrofitted.

UNIVERSAL DESIGN, VANITY BASE SINK REMOVABLE

32 1/2" High

21" Deep

Model	Cubic Feet	1	2	3
VBSR3032.521	13.7	•	501	•
VBSR3332.521	14.9	•	515	•
VBSR3632.521	16.3	•	528	•

- Cabinet must supported on both sides. Not intended for end of run.
- Front, cabinet bottom, and toekick are removable.
- Mini Touch-Up Kit (MTUK) included. MTUK includes small touch-up marker and small fill stick.
- Only available in Omni Snow.

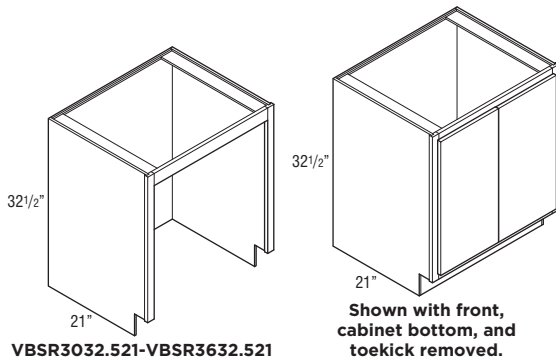
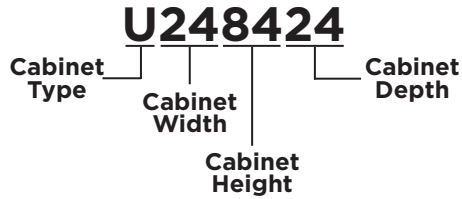

TABLE OF CONTENTS - TALL CABINETS



18" Wide Utility Single Door

84" High	.60
90" High	.60
93" High	.61
96" High	.61

24" Wide Utility Double Door

84" High	.62
90" High	.62
93" High	.63
96" High	.63

30" Wide Utility Double Door

84" High	.64
90" High	.64
93" High	.65
96" High	.65

33" Wide Oven 3 Drawers

84" High	.66
90" High	.66
93" High	.67
96" High	.67

18" WIDE UTILITY SINGLE DOOR

84" High

24" Deep

Model	Cubic Feet	1	2	3
U188424R	23.4	831	976	1123

- Roll tray kits available.
- Cabinet hinged on the right; door may be flipped for left hinge application.

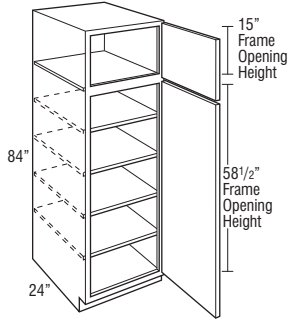

18" WIDE UTILITY SINGLE DOOR

90" High

24" Deep

Model	Cubic Feet	1	2	3
U189024R	25.4	927	1087	1249

- Roll tray kits available.
- Cabinet hinged on the right; door may be flipped for left hinge application.

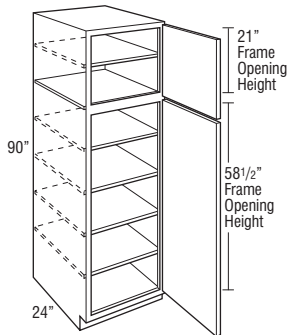

18" WIDE UTILITY SINGLE DOOR

93" High

24" Deep

Model	Cubic Feet	1	2	3
U189324R	26.1	943	1106	1274

- Separate pedestal base included on 93" tall.
- Roll tray kits available.
- Cabinet hinged on the right; door may be flipped for left hinge application.
- Not available in Classic Bark.

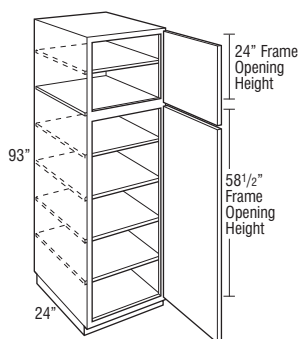

18" WIDE UTILITY SINGLE DOOR

96" High

24" Deep

Model	Cubic Feet	1	2	3
U189624R	27.0	1033	1214	1396

- Separate pedestal base included on 96" tall.
- Roll tray kits available.
- Cabinet hinged on the right; door may be flipped for left hinge application.

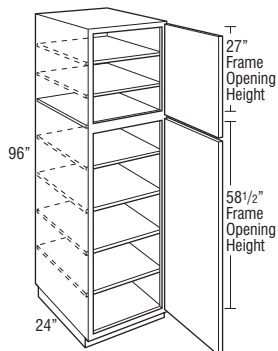

24" WIDE UTILITY DOUBLE DOOR

84" High

24" Deep

Model	Cubic Feet	1	2	3
U248424	30.9	1009	1191	1371

• Roll tray kits available.

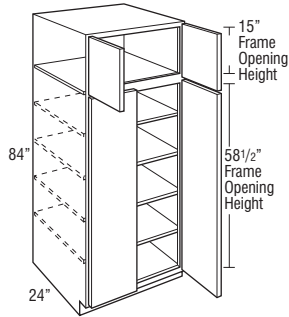

24" WIDE UTILITY DOUBLE DOOR

90" High

24" Deep

Model	Cubic Feet	1	2	3
U249024	33.4	1134	1334	1532

• Roll tray kits available.

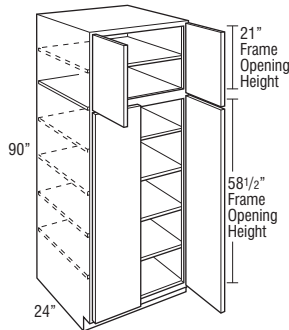

24" WIDE UTILITY DOUBLE DOOR

93" High

24" Deep

Model	Cubic Feet	1	2	3
U249324	34.5	1157	1361	1563

- Separate pedestal base included on 93" tall.
- Roll tray kits available.
- Not available in Classic Bark.

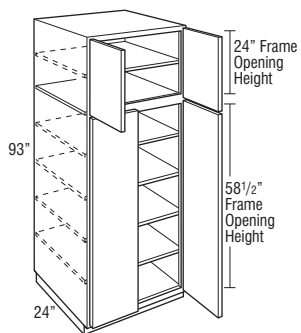

24" WIDE UTILITY DOUBLE DOOR

96" High

24" Deep

Model	Cubic Feet	1	2	3
U249624	35.6	1271	1496	1717

- Separate pedestal base included on 96" tall.
- Roll tray kits available.

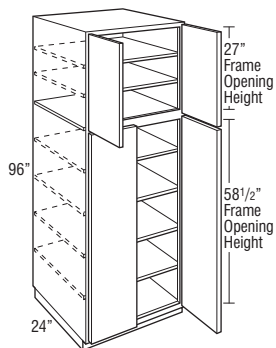

30" WIDE UTILITY DOUBLE DOOR

84" High

24" Deep

Model	Cubic Feet	1	2	3
U308424	43.0	1196	1408	1618

- Roll tray kits available.
- Not available in Classic Bark.

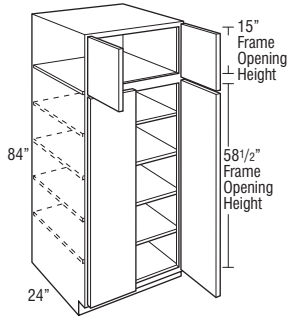

30" WIDE UTILITY DOUBLE DOOR

90" High

24" Deep

Model	Cubic Feet	1	2	3
U309024	46.0	1343	1580	1816

- Roll tray kits available.
- Not available in Classic Bark.

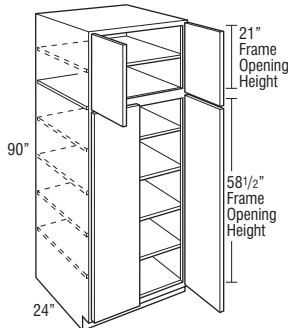

30" WIDE UTILITY DOUBLE DOOR

93" High

24" Deep

Model	Cubic Feet	1	2	3
U309324	46.5	1427	1679	1929

- Separate pedestal base included on 93" tall.
- Roll tray kits available.
- Not available in Classic Bark.

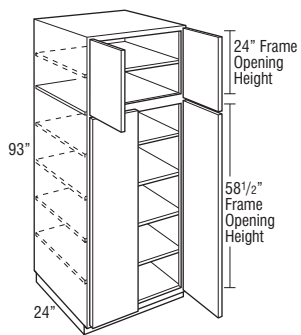

30" WIDE UTILITY DOUBLE DOOR

96" High

24" Deep

Model	Cubic Feet	1	2	3
U309624	49.0	1510	1776	2042

- Separate pedestal base included on 96" tall.
- Roll tray kits available.
- Not available in Classic Bark.

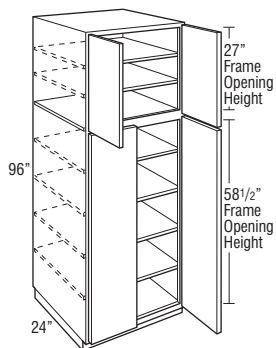

33" WIDE OVEN 3 DRAWERS

84" High

24" Deep

Model	Cubic Feet	1	2	3
OC3D338424	47.7	1324	1554	1785

- Oven cabinets feature an open back in cut-out area designed to improve field appliance installation.
- Metal appliance support brackets included for 24" deep cabinets.
- Confirm a heat shield is built into your appliance by the manufacturer.

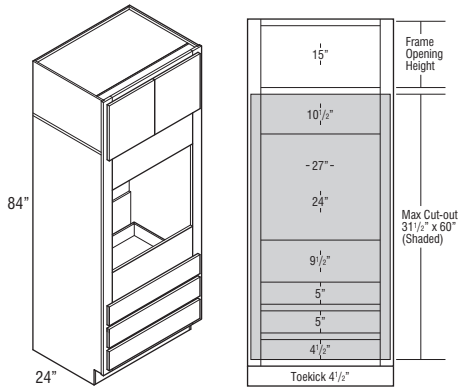

33" WIDE OVEN 3 DRAWERS

90" High

24" Deep

Model	Cubic Feet	1	2	3
OC3D339024	51.0	1549	1822	2095

- Oven cabinets feature an open back in cut-out area designed to improve field appliance installation.
- Metal appliance support brackets included for 24" deep cabinets.
- Confirm a heat shield is built into your appliance by the manufacturer.

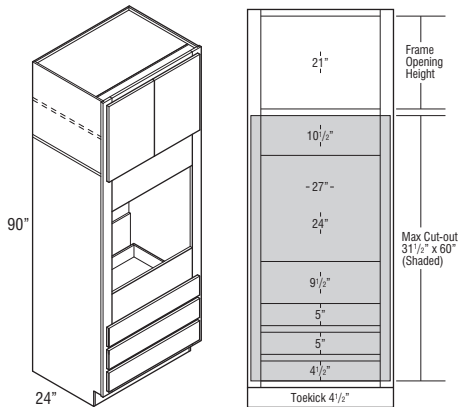

33" WIDE OVEN 3 DRAWERS

93" High

24" Deep

Model	Cubic Feet	1	2	3
OC3D339324	52.6	1585	1865	2146

- Oven cabinets feature an open back in cut-out area designed to improve field appliance installation.
- Metal appliance support brackets included for 24" deep cabinets.
- Separate pedestal base included on 93" tall.
- Confirm a heat shield is built into your appliance by the manufacturer.
- Not available in Classic Bark.

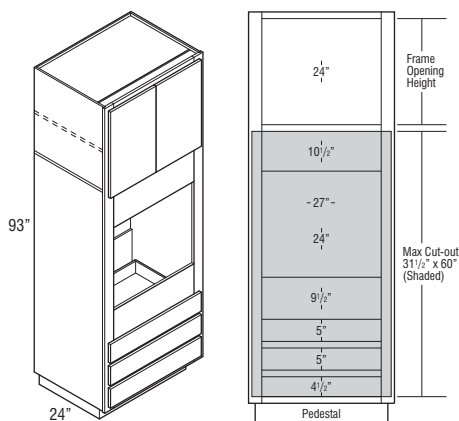

33" WIDE OVEN 3 DRAWERS

96" High

24" Deep

Model	Cubic Feet	1	2	3
OC3D339624	54.3	1744	2054	2363

- Oven cabinets feature an open back in cut-out area designed to improve field appliance installation.
- Metal appliance support brackets included for 24" deep cabinets.
- Separate pedestal base included on 96" tall.
- Confirm a heat shield is built into your appliance by the manufacturer.

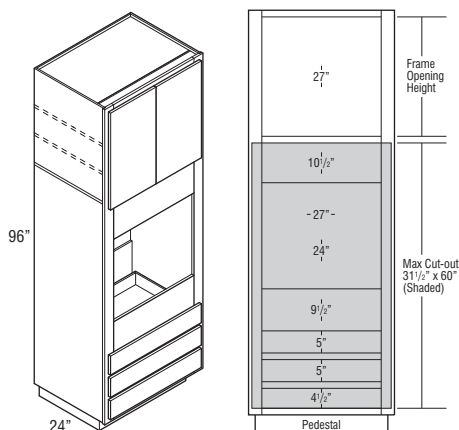
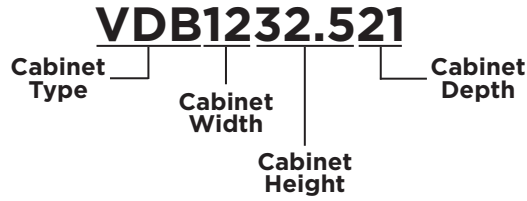

TABLE OF CONTENTS - VANITY CABINETS



32 1/2" High, 21" Deep

Vanity Drawer Base69
 Vanity Sink Base70

34 1/2" High, 18" Deep

Vanity Sink Base70

34 1/2" High, 21" Deep

Vanity Base with Drawer71
 Vanity Drawer Base71
 Vanity Sink Base72
 Vanity Sink Drawer Base72

VANITY DRAWER BASE

32½" High

21" Deep

Model	Cubic Feet	1	2	3
VDB1232.521	5.7	440	516	591
VDB1532.521	7.1	481	567	653
VDB1832.521	8.4	526	616	710

• On door styles with slab drawer fronts, all drawer fronts will be slab.

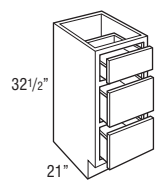

VANITY SINK BASE

32½" High

21" Deep

Model	Cubic Feet	1	2	3
VSB2432.521	11.0	351	415	477
VSB3032.521	13.7	391	461	533
VSB3632.521	16.3	453	533	612

• Tilt-out tray kits available.

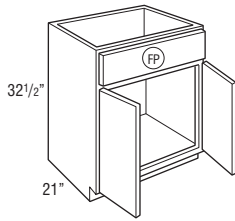

VANITY SINK BASE

34½" High

18" Deep

Model	Cubic Feet	1	2	3
VSB243418	10.2	•	503	•

• Tilt-out tray kits available.
• Only available in Omni Snow.

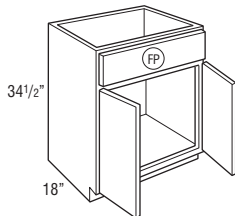

VANITY BASE SINGLE DOOR

34½" High

21" Deep

Model	Cubic Feet	1	2	3
VB153421R	7.6	335	393	453
VB183421R	9.0	365	425	492

- Cabinet hinged on the right; door may be flipped for left hinge application.

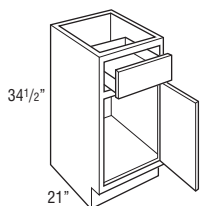

VANITY DRAWER BASE

34½" High

21" Deep

Model	Cubic Feet	1	2	3
VDB123421	6.2	440	516	591
VDB153421	7.6	481	567	653
VDB183421	8.9	526	616	710

- On door styles with slab drawer fronts, all drawer fronts will be slab.

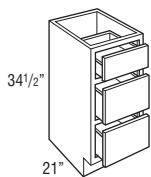

VANITY SINK BASE

34 1/2" High

21" Deep

Model	Cubic Feet	1	2	3
VSB243421	11.9	351	415	477
VSB273421 <small>new</small>	13.3	372	438	505
VSB303421	14.7	391	461	533
VSB363421	17.5	453	533	612

• Tilt-out tray kits available.

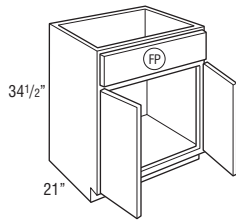

VANITY SINK DRAWER BASE

34 1/2" High

21" Deep

Model	Cubic Feet	1	2	3
2VSD363421	17.4	600	708	811
2VSD423421	20.3	653	769	884
2VSD483421CS	23.1	714	842	969

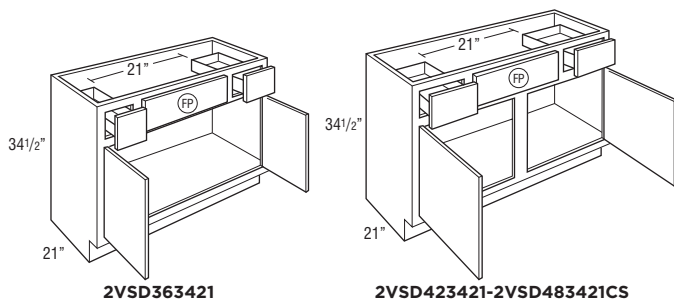

VANITY SINK DRAWER BASE

34 1/2" High

21" Deep

Model	Cubic Feet	1	2	3
3VSD303421	14.7	•	759	876
3VSD363421	17.5	•	884	1014

- Top drawer is scoop drawer; 6 inches from top.
- Matching finished interior.
- 3VSD has open toekick. Toeboard can be used to cover if not desired.
- Door(s) are on the left and drawers are on the right; cannot be flipped.

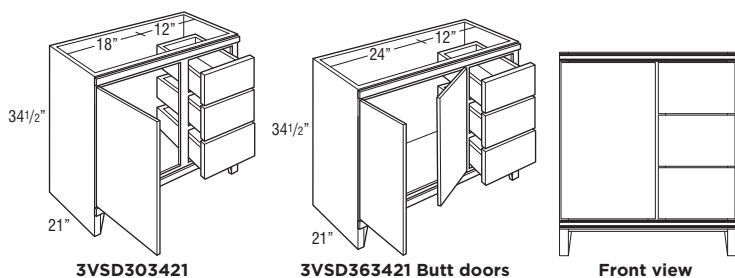

TABLE OF CONTENTS - FILLERS, SKINS, PANELS, & MOULDING

Fillers	75
Skins	77
Panels	79
Crown Moulding	82
Starter Moulding	84
Accent Moulding	85
Corner Moulding	86
Toeboard	88
Straight Valance / Baseboard	88

3" FILLER

Model	Cubic Feet	Price
F330	0.2	46
F336	0.2	51
F342	0.2	57
TF396FH	0.5	128

- 3/4" thick.
- Finished on front and two long edges (backs are not finished).

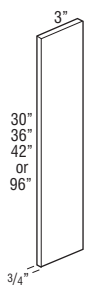

6" FILLER

Model	Cubic Feet	Price
F630	0.2	85
F636	0.2	93
F642	0.2	106
TF696FH	0.5	204

- 3/4" thick.
- Finished on front and two long edges (backs are not finished).

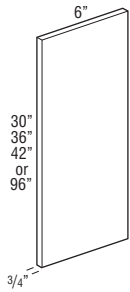

END PANEL SKINS

Model	Cubic Feet	Price
WEPS42LAM14	0.5	90
BEPS34.514	0.7	82
TEPS96LAM14	2.7	157

- 1/4" thick laminated furniture board.
- One side matching exterior and the other side Natural Maple laminate interior.

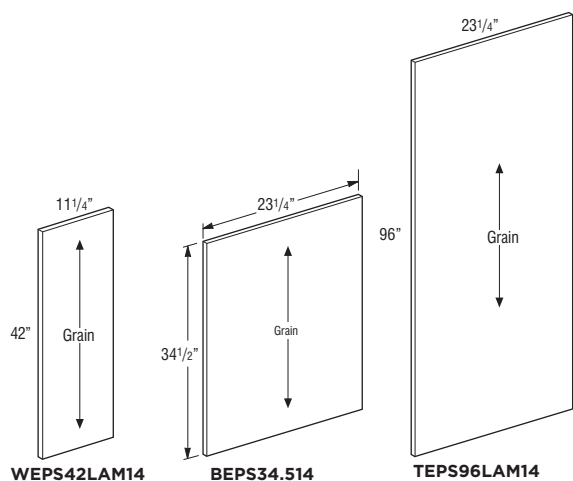

FINISHED BACK SKINS

Model	Cubic Feet	Price
BP4834.514	1.1	93

- 1/4" thick laminated furniture board.
- Grain runs with 34.5".
- One side matching exterior and the other side is unfinished.

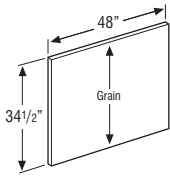

FINISHED BACK SKINS

Model	Cubic Feet	Price
BP4896LAM14	2.7	204

- 1/4" thick laminated furniture board.
- Grain runs with 96".
- One side matching exterior and the other side is unfinished.

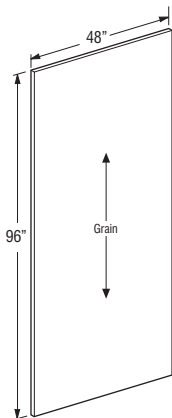

PLYWOOD END PANELS

Model	Cubic Feet	Price
BEPWD <small>new</small>	0.7	135
WEP1230WD <small>new</small>	0.3	148
TEP2496WD <small>new</small>	1.3	255

- 3/4" Plywood panel with lamination paper on both sides, edgeband on front edge.
- Only available in Classic Snow, Omni Snow, and Spectra Snow.

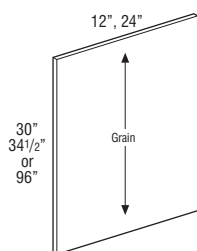

TALL END PANEL

Model	Cubic Feet	Price
TEP2484LAM	1.3	224
TEP2496LAM	1.3	268
TEP3096LAM	1.3	335

- 3/4" thick laminated furniture board.
- Panels are edgebanded on front edge.
- Matching exterior on both sides.

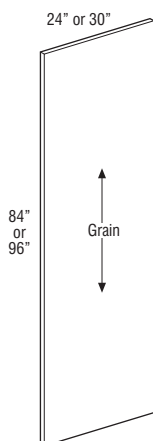

Pricing effective 8/9/24
New SKUs available 8/19/24

BASE AND TALL PANELS WITH FILLER ATTACHED

Model	Cubic Feet	Price
BEPF1.5LAM	1.7	120
BEPF3LAM	1.7	145
TEP2496F1.5	1.3	309
TEP3096F1.5	1.3	464

- 1/2" thick laminated furniture board.
- One side matching exterior and the other side Natural Maple laminate interior.

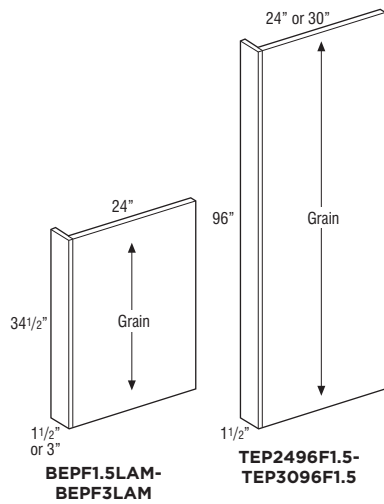

WALL END DECORATIVE DOOR PANEL KIT

Model	Cubic Feet	1	2	3
WED1230	0.8	•	158	183
WED1236	0.9	•	181	210
WED1239	1.0	•	195	224
WED1242	1.1	•	208	239

• Door panel kits include Wall End Panel Skin and doors with attachment screws for field installation.

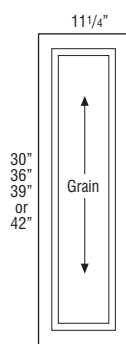

BASE END DECORATIVE DOOR PANEL KIT

Model	Cubic Feet	1	2	3
BEDSD	1.6	•	239	272

• Door panel kits include Base End Panel Skin and doors with attachment screws for field installation.

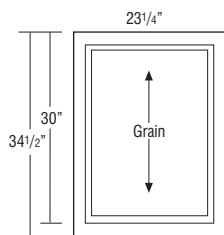

CROWN MOULDING, SOLID WOOD CROWN

Model	Cubic Feet	Price
SWCRM8	0.5	114

- Face mounts on Partial Overlay doors.
- May be face mounted on Full Overlay if used with a cleat.
- One 8' section.
- Moulding can be used as standard or inverted.
- Finished edges indicated by bold lines on side view drawings.

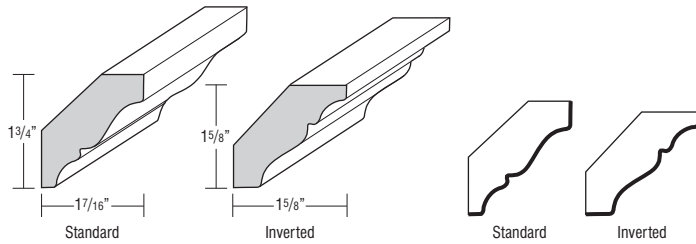

CROWN MOULDING, SOLID WOOD LARGE CROWN

Model	Cubic Feet	Price
SWLCRM8	0.5	147

- Face mounts on Partial Overlay doors.
- May be face mounted on Full Overlay if used with a cleat.
- One 8' section.
- Moulding can be used as standard or inverted.
- Finished edges indicated by bold lines on side view drawings.

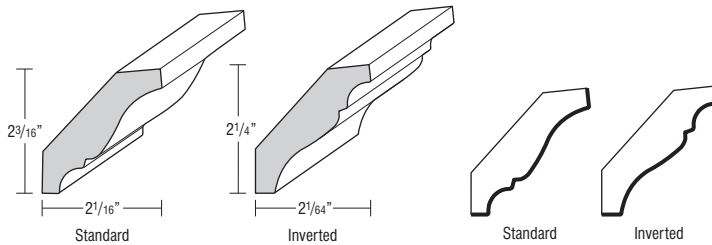

CROWN MOULDING, SMALL COVE CROWN

Model	Cubic Feet	Price
SMCOVECROWN8	1.0	185

- One 8' section.
- Finished edges indicated by bold lines on side view drawings.

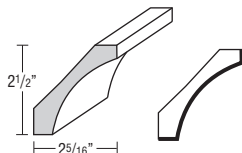

CROWN MOULDING, COVE CROWN

Model	Cubic Feet	Price
COVECROWN8	1.0	229

- One 8' section.
- Cleat shipped unattached can be used for top mount or face frame applications.
- Finished edges indicated by bold lines on side view drawings.

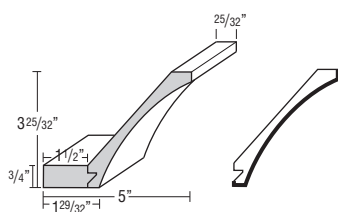

LARGE SHAKER CROWN

Model	Cubic Feet	Price
LSHAKER8	1.0	140

- One 8' section.
- Finished edges indicated by bold lines on side view drawings.
- Not available in Classic Bark.

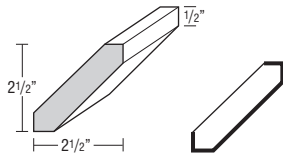

STARTER MOULDING, SHAKER

Model	Cubic Feet	Price
STRS8	1.0	357

- One 8' section.
- Finished edges indicated by bold lines on side view drawings.

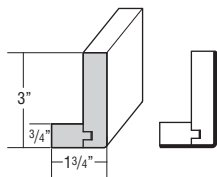

ACCENT MOULDING, FLAT SCRIBE

Model	Cubic Feet	Price
SM8	0.5	46

- One 8' section.
- Finished edges indicated by bold lines on side view drawings.

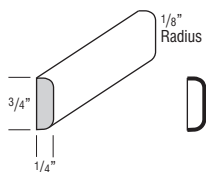

ACCENT MOULDING, SMALL SCRIBE

Model	Cubic Feet	Price
SSM8	0.5	44

- One 8' section.
- Finished edges indicated by bold lines on side view drawings.

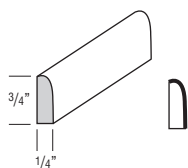

Note: This item will be stocked until 10/1/24, then discontinued.

ACCENT MOULDING, SMALL SCRIBE

Model	Cubic Feet	Price
SCRIBE8 <small>new</small>	0.5	46

- One 8' section.
- Finished edges indicated by bold lines on side view drawings.

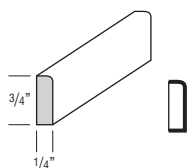

Note: This item is available for special order. It will be in-stock starting 9/15/24.

ACCENT MOULDING, LIGHT BAFFLE

Model	Cubic Feet	Price
LB2	0.5	82

- One 8' section.
- Finished edges indicated by bold lines on side view drawings.

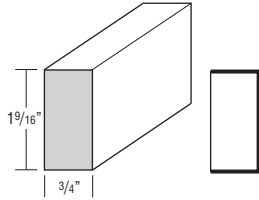

CORNER MOULDING, INSIDE CORNER

Model	Cubic Feet	Price
ICM8	0.5	65

- One 8' section.
- Finished edges indicated by bold lines on side view drawings.

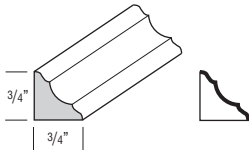

CORNER MOULDING, OUTSIDE CORNER

Model	Cubic Feet	Price
OCM8	0.5	65

- One 8' section.

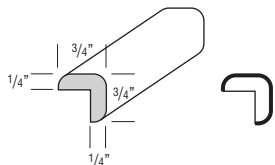

CORNER MOULDING, QUARTER ROUND

Model	Cubic Feet	Price
QRM	0.5	68

- One 8' section.
- Finished edges indicated by bold lines on side view drawings.

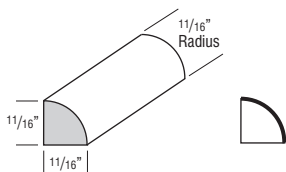

TOEBOARD

Model	Cubic Feet	Price
TB8LAM18	0.1	37
TB8LAM14	0.1	46

- One 8' section.
- TB8LAM18: 1/8" laminated furniture board.
- TB8LAM14: 1/4" laminated furniture board.

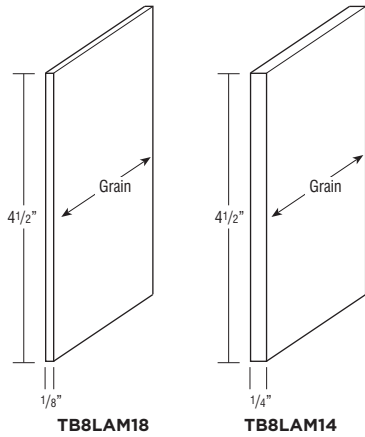

STRAIGHT VALANCE / BASEBOARD

Model	Cubic Feet	Price
VV48	0.4	80
VV96	0.4	157

- Trimmable.
- Profiled bottom edge 3/4" thick.

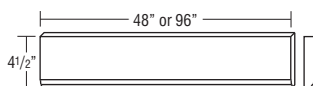

TABLE OF CONTENTS - ACCESSORIES

Classic Square Wood Hood90
 Classic Wood Hood Chimney90
 Wood Hood Blower91
 Roll Tray Kits92
 Tilt-out Trays93
 Cutlery Insert Wood Organizer94
 Stain, Paint, & Touch-up Tools95

CLASSIC SQUARE WOOD HOOD

Model	Cubic Feet	Price
WHS36	30.0	2544

- Freestanding unit (must be properly secured to wall and cannot be attached to adjacent cabinets).
- Exhaust system not included. Compatible with BLOWER400.
- Compatible with Classic Wood Hood Chimney (WHC_ _), which can be trimmed. See below.
- Check your local building code for installation heights above the range.
- Silver metallic liner included. Assembly required.
- Installation instructions and hardware included.
- Liner opening size: 10 1/4" deep by 19 1/2" wide.
- Only available in Classic Snow, Omni Snow, and Spectra Snow.

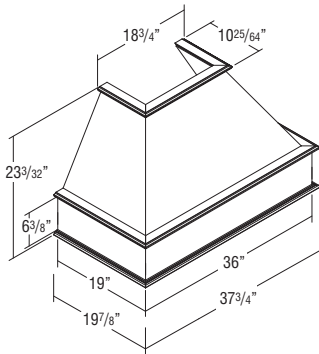

CLASSIC WOOD HOOD CHIMNEY

Model	Cubic Feet	Price
WHC36	4.1	479

- 3/4" thick plywood.
- Trimmable.
- If trimmed, moulding is recommended to conceal any cut marks.
- Only available in Classic Snow, Omni Snow, and Spectra Snow.

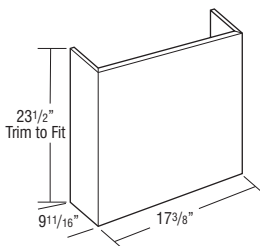

WOOD HOOD BLOWER, 400 CFM

Model	Cubic Feet	Price
BLOWER400	2.9	972

- 400 CFM, Energy Star rated.
- Two 2.8 watt (250+ Lumens) LED lights included.
- Installation instructions, warranty, and repair information included.
- Stainless Steel finish.
- Three speed rotary switch control.
- Includes removable dishwasher safe grease filter.
- Heat Sentry technology included.
- Sound rating is 7.0 sones on highest setting.
- Vertical ducting requires 7" diameter vent.
- 1 year warranty.

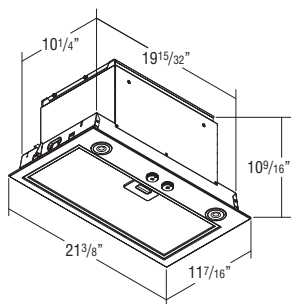

ROLL TRAY KITS

Model	Cubic Feet	Price
RT15WD	0.5	131
RT18WD	0.8	138
RT21WD	0.9	142
RT24WD	1.0	147
RT27WD	1.4	153
RT30WD	1.4	157
RT33WD	1.6	165
RT36WD	1.6	171
RT42WD	1.8	282

- 5/8" solid-wood dovetail roll tray with soft-closing, undermount, full extension guides.
- RT15WD-RT36WD kits contain 1 roll tray, roll tray brackets, hardware, and screws.
- RT42WD kits contain 2 roll trays, roll tray brackets, hardware, and screws.
- Exterior dimensions of roll trays are 21" deep x 3 3/8" tall (fits standard 24" deep cabinet).

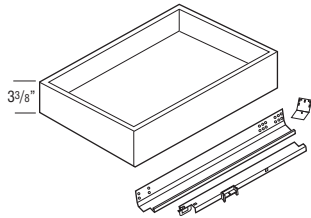

Width	Application
15"	B15, B15FH, B1532.5
18"	B18, B18FH, B1832.5, U18
21"	B21, B2132.5
24"	B24, B24FH, B2432.5, U24
27"	B27, B2732.5
30"	B30, B30FHB, B3032.5, U30
33"	B33, B3332.5
36"	B36, B36FH, B3632.5
42"	B42, B4232.5

TILT-OUT TRAYS

Model	Cubic Feet	Price
TOT15	0.1	85
TOT18	0.2	85

- TOT15: 11" w X 2" d X 3 3/4"
- TOT18: 14 1/4" w X 2" d X 3 3/4"
- Kit includes two white plastic trays and one pair of tilt-out hinges that attaches to the inside of the false panel.
- One tilt-out tray per false panel on cabinets less than 30" wide and greater than 36" wide, two tilt-out trays attached to one false panel on 30"-36" wide cabinets.

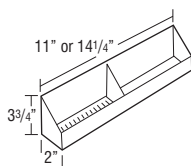

Cab Width	TOT Size	Cabinets
24"	TOT18	SB24, VSB2432.521, VSB243418, VSB243421
27"	TOT18	SB27, SB2732.5, VSB273421
30"	TOT15	SB30, VSB3032.521, VSB303421
33"	TOT15	SB33
36"	TOT18	SB36, VSB3632.521, VSB363421
42"	TOT18	SB42

CUTLERY INSERT WOOD ORGANIZER

Model	Cubic Feet	Price
CIW15	1.0	149
CIW18	1.0	159
CIW21	1.0	206
CIW24	1.0	220

- Pre-assembled natural wood drawer insert.
- Place a cabinet with a CIW next to the dishwasher for convenience.

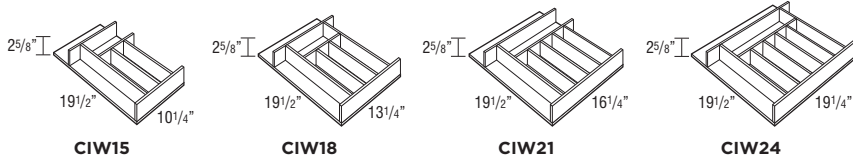

Model	Application
CIW15	15" Base
CIW18	18" Base
CIW21	21" Base
CIW24	24" Base

STAIN & PAINT

Model	Cubic Feet	Price
QUARTCOLOR	0.1	128
SSC	0.1	48
SSCCLEAR	0.1	48

- Wiping stain can be sprayed at low pressure.
- SSC is a 384 mL aerosol can available in Paint colors.
- SSCCLEAR is a 384 mL aerosol can in clear.

TOUCH-UP KIT

Model	Cubic Feet	Price
TUK	0.1	67
MTUK	0.1	40

- TUK includes touch-up marker and a fill stick.
- MTUK includes small touch-up marker and a small fill stick.

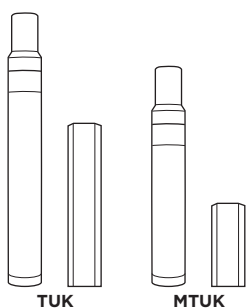

ESSENCE

ADVANTAGE

BY MASTERBRAND



**National Forest
Foundation**

Essence Advantage cabinets have a five year limited warranty. For terms & conditions and Cabinet Care and Cleaning Instructions, please visit wmsdist.com/essence-advantage/resources. Styles, product availability and construction may vary slightly from those shown due to material availability and/or design evolution. Specifications are subject to change without notice. Our customer service team is available if your design requires verification of product availability and specifications.