

HOMECREST[®]

C A B I N E T R Y



CABINERY PRICE & SPECIFICATIONS GUIDE

PRICES EFFECTIVE 3.11.24
SUPERSEDES ALL PRIOR VERSIONS

HOME CREST[®]

C A B I N E T R Y



MARCH 2024 LAUNCH IS HERE



HAYLAN

Its slim profile maintains the traditional shaker style while offering a sleek, minimalist appearance and touch of sophistication. This contemporary mitered door features a 3/4" stile and rail profile with veneer door and drawer front center panels for stain finishes and a MDF center panel for paint finishes.

Available on Maple and Painted Hardwood.



WHY YOU'LL CARE:

Narrow rail shaker style is trending and will help meet consumer demands.

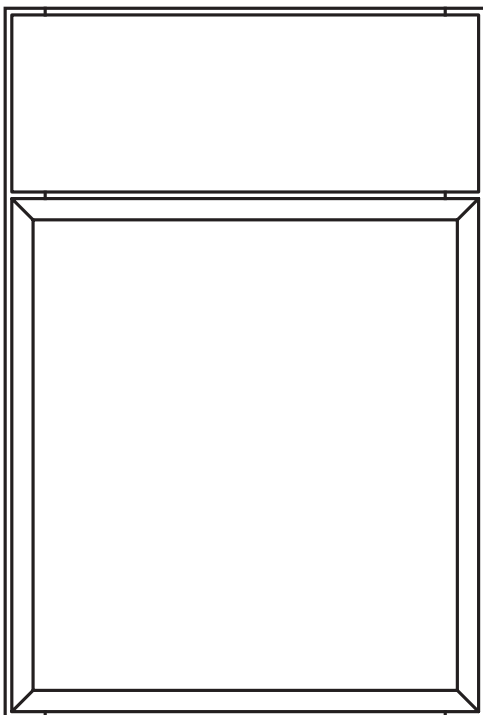

STANDARD SLAB DRAWER FRONT

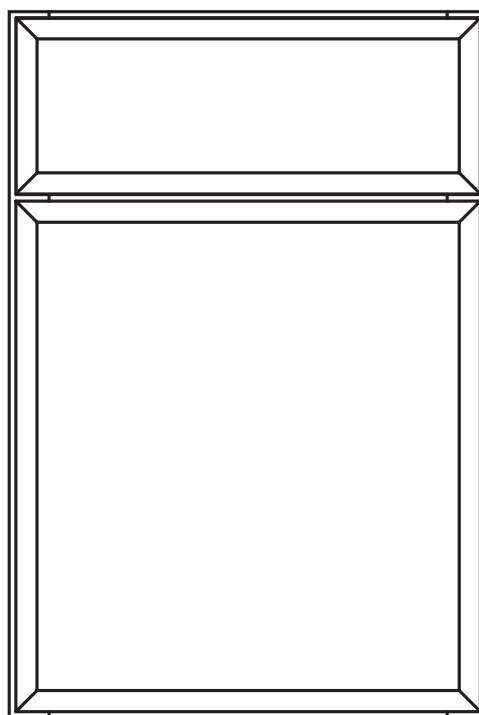

OPTIONAL 5-PIECE DRAWER FRONT

WOOD HOODS

Wood hoods bring natural beauty and character to the kitchen and complement various design styles.

INTRODUCING FOUR NEW WOOD HOOD OPTIONS!

ARTISAN STRAIGHT

The Artisan Straight wood hood will be the focal point of your kitchen, adding style and sophistication. Available in all species.

SKUs: WHAS30, WHAS36, WHAS42

WATERFALL

The Waterfall wood hood mimics a cascade effect providing a sleek and unified appearance. Available in all species.

SKUs: WHWF36, WHWF42

CRAFTSMAN STRAIGHT

The Craftsman Straight hood emphasizes clean, straight lines that will integrate seamlessly in any kitchen. Available in all species.

SKUs: WHCFS30, WHCFS36

SIGNATURE MANTEL

This Signature Mantel wood hood will serve as a statement piece, instilling the kitchen with timeless character. Available in all species.

SKUs: WHSGM3030, WHSGM3630, WHSGM3036, WHSGM3636



Simple Tapered Wood Hood



ARTISAN STRAIGHT



WATERFALL



CRAFTSMAN STRAIGHT



SIGNATURE MANTEL

120" TALL PANELS, SKINS AND FILLERS

10' floor to ceiling end panels are here!
Available in Maple and Painted Hardwood.

FILLERS

F3120FH, F6120FH

END PANEL SKINS

WTEP120

END PANELS

SP12120, SP24120

REFRIGERATOR PANELS WITH FILLER ATTACHED

WREP1.524120, WREP324120

REFRIGERATOR PANELS WITH FILLER ATTACHED AND FURNITURE ENDS

WREP1.524120FPE, WREP324120FPE

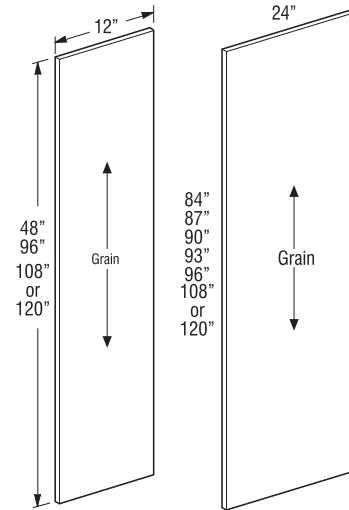

WHY YOU'LL CARE:

For designs with tall ceilings, these full-height panels save installation time and cost.

CUSTOM CHOICE™ UPDATE

To accommodate larger refrigerators, appliance panels are now available up to 36" wide and 84" high through Custom Choice.

- Dover door style will convert to a flat center panel when larger than 24" wide or 70" tall.
- Larger appliance panels are not available in Chalet, Fyfer, Piper, Wexford and Welzin door styles.
- See the price and specification guide for additional details on Custom Choice.

PRODUCT CHANGES

BEXLEY AND LAUTNER RAIL CHANGE

The rail width on Bexley and Lautner is transitioning from 2 3/4" to 2 1/2".

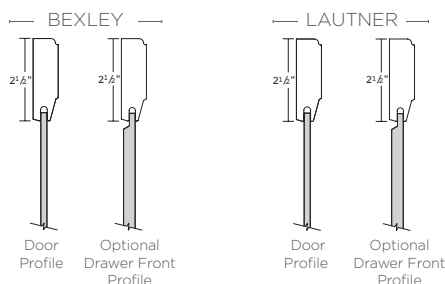

WELZIN 10"+ DRAWER FRONT TRANSITION

The Welzin 10"+ drawer front is transitioning to a standard raised center panel to align with all other solid raised panel door styles across the Homecrest portfolio.

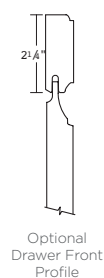



STAY SHARP.

eLearning Training Modules are refreshed and available for self-training, anytime, anywhere.

Take advantage of the MasterBrand eLearning Library available through MasterBrand Connect. This interactive training platform offers Homecrest training modules for you to access on-demand 24/7/365. Take a few minutes now to freshen up your product knowledge.

You can help shape the library of content by reaching out and sharing the training topics that you are seeking. Email your suggestions to mbmarketing@masterbrand.com

PRICE AND SPECIFICATION INSERT PAGES

March 2024 new products will not be found in their respective categories within printed price and specification guides. However, the following pages can be printed and inserted for future reference.



DOOR STYLES

Haylan 

	Hickory	Maple	Oak	Painted Hardwood	Rustic Hickory	Laminate	PureStyle™
Price Point	—	7	—	7	—	—	—

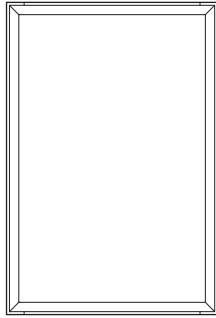

Wall

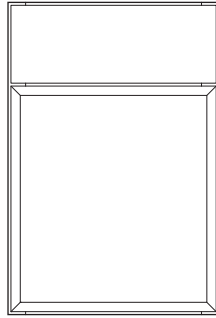

Base

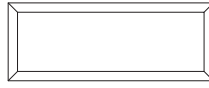

Optional 5-piece Drawer Front (DFF5PC)

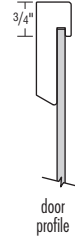

door profile



3/4" drawer front profile



3/4" optional drawer front profile

- Full/Modified Full Overlay
- 3/16" Veneer Recessed Center Panel in 3/4" Hardwood Frame

- 45° Mitered Joints
- 3/4" Solid Hardwood Slab Drawer Front
- See page 26 for 5-piece drawer front dimensions when specifying decorative hardware.

NEW Artisan Straight Wood Hood

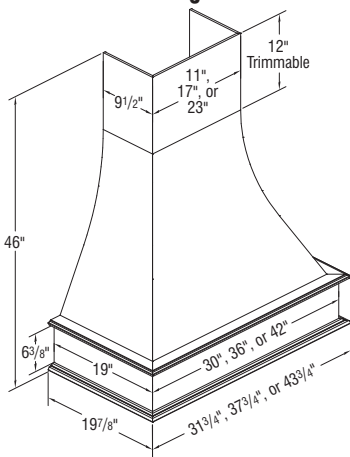

Price Point	1	2	3	4	5	6	7	8
WHAS30	3019	3019	3019	3019	3019	3019	3019	3019
WHAS36	3044	3044	3044	3044	3044	3044	3044	3044
WHAS42	3239	3239	3239	3239	3239	3239	3239	3239

- Freestanding unit (must be properly secured to wall and cannot be attached to adjacent cabinets).
- Exhaust system not included. Compatible with all Homecrest blowers.
- Chimney height is trimmable up to 34".
- Check local building code and appliance installation specifications for clearance requirements and installation heights above the range.
- Silver metallic liner included. Assembly required.
- Liner opening size: 10 1/4" deep by 19 1/2" wide.
- Installation instructions and hardware included.
- Painted Hardwood will be used for PureStyle™.
- When ordering Rustic Hickory, Hickory will be substituted.
- No changes or cancellations will be accepted after 24 hours from acknowledgment of order.

MODIFICATIONS
No modifications available for these products.

NEW Waterfall Wood Hood

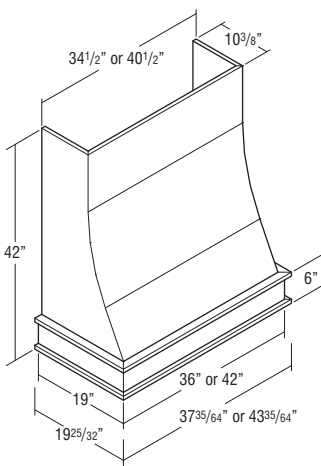

WHWF36	3350	3350	3350	3350	3350	3350	3350	3350
WHWF42	3620	3620	3620	3620	3620	3620	3620	3620

- Freestanding unit (must be properly secured to wall and cannot be attached to adjacent cabinets).
- Exhaust system not included. Compatible with all Homecrest blowers.
- Chimney height is trimmable up to 34".
- Check local building code and appliance installation specifications for clearance requirements and installation heights above the range.
- Silver metallic liner included. Assembly required.
- Liner opening size: 10 1/4" deep by 19 1/2" wide.
- Installation instructions and hardware included.
- Painted Hardwood will be used for PureStyle™.
- When ordering Rustic Hickory, Hickory will be substituted.
- No changes or cancellations will be accepted after 24 hours from acknowledgment of order.

MODIFICATIONS
No modifications available for these products.

NEW Craftsman Straight Wood Hood

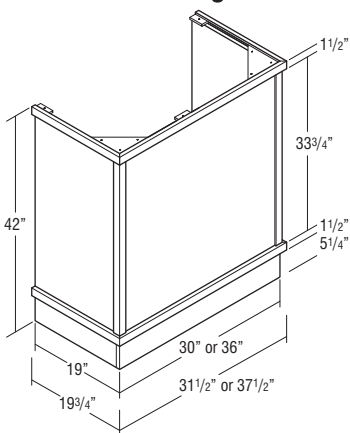

WHCFS30	2650	2650	2650	2650	2650	2650	2650	2650
WHCFS36	2865	2865	2865	2865	2865	2865	2865	2865

- Freestanding unit (must be properly secured to wall and cannot be attached to adjacent cabinets).
- Exhaust system not included. Compatible with all Homecrest blowers.
- Compatible with Simple Wood Hood Chimney (WHSMC_ _), which can be trimmed.
- Check local building code and appliance installation specifications for clearance requirements and installation heights above the range.
- Silver metallic liner included. Assembly required.
- Liner opening size: 10 1/4" deep by 19 1/2" wide.
- Installation instructions and hardware included.
- Glaze finishes not available.
- Painted Hardwood will be used for PureStyle™.
- When ordering Rustic Hickory, Hickory will be substituted.
- No changes or cancellations will be accepted after 24 hours from acknowledgment of order.

MODIFICATIONS
No modifications available for these products.

NEW Signature Mantel Hood

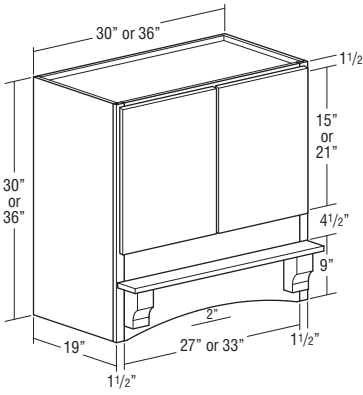

Price Point	1	2	3	4	5	6	7	8
WHSGM3030	2928	2928	2928	2928	2928	2928	2928	2928
WHSGM3036	3231	3231	3231	3231	3231	3231	3231	3231
WHSGM3630	3253	3253	3253	3253	3253	3253	3253	3253
WHSGM3636	3618	3618	3618	3618	3618	3618	3618	3618

- Exhaust system not included. Compatible with all Homecrest blowers.
- Operable doors matching the style ordered will be installed on hood.
- Check local building code and appliance installation specifications for clearance requirements and installation heights above the range.
- Silver metallic liner included. Assembly required.
- Liner opening size: 10 1/4" deep x 19 1/2" wide.
- Installation instructions and hardware included.
- Glaze finishes not available.
- Painted Hardwood will be used for PureStyle™.
- When ordering Rustic Hickory, Hickory will be substituted.
- No changes or cancellations will be accepted after 24 hours from acknowledgment of order.

Modifications

ADDTK	AUTH	CBO	CCO	CFNTO	CFRMO	CND	EX	FB	FDRW	FPEB	FTK	FTK_V	FULL/MFO	ID	MI	NSCH	P	RD	RECTKL/R

Construction Upgrades

APU	PEU

Decorative Door Options

CG	MD

3" Wide Fillers

UF3	60
F333	64
F336	64
F339	69
F342	75
F348	84
F351	90
F354	96
F357	102
F360	108
F384	134
F387	134
F390	144
F393	144
F396	153
F396FH	153
F3108FH†	207
F3120FH† 	217

- 3/4" thick.
 - Finished on front and all edges (backs are unfinished).
- †F3108FH and F3120FH only available in Maple and Painted Hardwood.

Species Availability

Hickory	Maple	Oak	Painted	Rustic Hickory	Laminate
•	•	•	•	Hickory	Painted

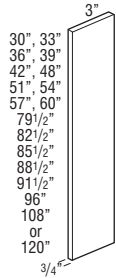

6" Wide Fillers

UF6	110
F633	118
F636	118
F639	127
F642	139
F684	232
F687	232
F690	247
F693	247
F696	263
F696FH	263
F6108FH†	355
F6120FH† 	373

- 3/4" thick.
 - Finished on front and all edges (backs are unfinished).
- †F6108FH and F6120FH only available in Maple and Painted Hardwood.

Species Availability

Hickory	Maple	Oak	Painted	Rustic Hickory	Laminate
•	•	•	•	Hickory	Painted

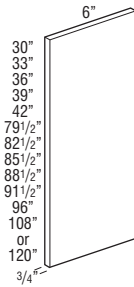

End Panel Skins

WBEP	134
WTEP1284	193
WTEP1296	222
WTEP84	321
WTEP96	370
WTEP108†	556
WTEP120† 	612
WWEP30	64
WWEP33	75
WWEP36	75
WWEP39	82
WWEP42	86
WWEP48	101

- Paints will be constructed of MDF.
- 1/4" thick wood veneered, MDF core.
- 12" deep panels - ID15, ID18, ID21, ID24, ID27, and ID30 available. RD9, RD6 available.
- 21" deep panels - ID24, ID27, and ID30 available. RD12, RD15, and RD18 available.
- 24" deep panels - ID27 and ID30 available. RD12, RD15, RD18, and RD21 available.

†WTEP108 and WTEP120 only available in Maple and Painted Hardwood. ID not available on 108" and 120" panels.

Species Availability



Hickory	Maple	Oak	Painted	Rustic Hickory	Laminate
•	•	•	•	Hickory	Painted

Modifications

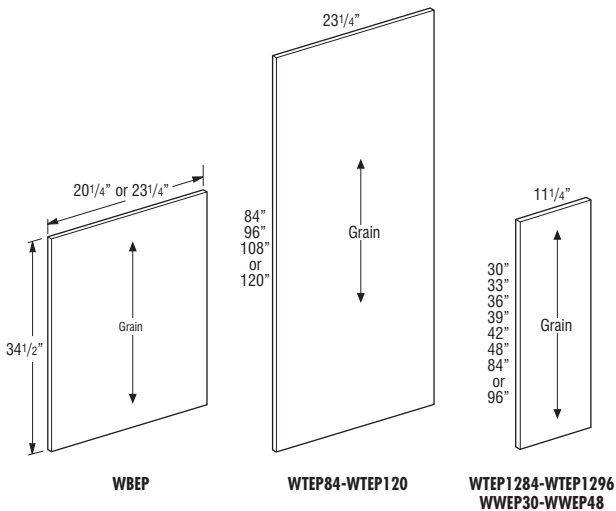
ID	RD
•	•



End Panels

SP1230	169
SP1248	188
SP1296	371
SP12108†	575
SP12120† 	633
SP2434.5	211
SP2484	547
SP2487	567
SP2490	587
SP2493	607
SP2496	627
SP24108†	970
SP24120† 	1067
SP3084	682
SP3096	785

- 3/4" thick veneered furniture board finished on both sides and front edge.
 - 12" deep panels - ID15, ID18, ID21, ID24, ID27, and ID30 available. RD9, RD6 available.
 - 24" deep panels - ID27 and ID30 available. RD12, RD15, RD18, and RD21 available.
 - 30" deep panels - RD27 available.
- †SP12108, SP12120, SP24108, and SP24120 only available in Maple and Painted Hardwood. ID not available on 108" and 120" panels. 3/4" thick veneered plywood.

Modifications



APU	ID	RD
•	•	•

Species Availability

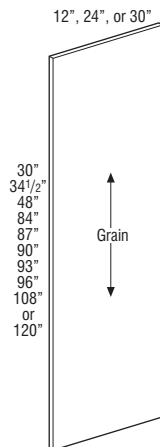
Hickory	Maple	Oak	Painted	Rustic Hickory	Laminate
•	•	•	•	Hickory	Painted



Refrigerator Panels with Filler Attached

WREP1.52484	616
WREP1.52487	666
WREP1.52490	666
WREP1.52493	707
WREP1.52496	707
WREP1.524108†	1060
WREP1.524120† 	1166
WREP32484	668
WREP32487	712
WREP32490	712
WREP32493	762
WREP32496	762
WREP324108†	1144
WREP324120† 	1258

- 1/2" thick plywood.
- 1/4" reveal on filler at panel attachment.
- Total panel depth includes 3/4" thick filler. Example: WREP1.52484 = panel depth of 24".
- 24" deep panels - ID27 and ID30 available. RD12, RD15, RD18 and RD21 available.

†WREP1.524108, WREP1.524120, WREP324108, and WREP324120 only available in Maple and Painted Hardwood. ID and MI not available on 108" and 120" panels.

Species Availability

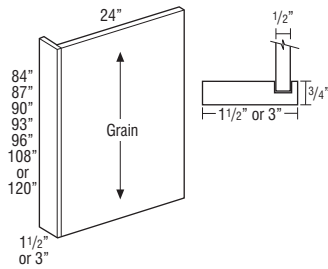

Hickory	Maple	Oak	Painted	Rustic Hickory	Laminate
•	•	•	•	Hickory	Painted



Modifications

ID	MI	RD
•	•	•

Refrigerator Panels with Filler Attached and Furniture Ends

WREP1.52484FPE	727
WREP1.52487FPE	786
WREP1.52490FPE	786
WREP1.52493FPE	834
WREP1.52496FPE	834
WREP1.524108FPE†	1251
WREP1.524120FPE† 	1376
WREP32484FPE	788
WREP32487FPE	840
WREP32490FPE	840
WREP32493FPE	899
WREP32496FPE	899
WREP324108FPE†	1350
WREP324120FPE† 	1485

- 3/4" thick plywood.
- Total panel depth includes 3/4" thick filler. Example: WREP1.52484FPE = panel depth of 24".
- 24" deep panels - ID27 and ID30 available. RD12, RD15, RD18 and RD21 available.

†WREP1.524108FPE, WREP1.524120FPE, WREP324108FPE, and WREP324120FPE only available in Maple and Painted Hardwood with MI standard. ID not available on 108" and 120" panels.

Modifications

FPEB	ID	MI	RD
STD	•	•	•

Species Availability

Hickory	Maple	Oak	Painted	Rustic Hickory	Laminate
•	•	•	•	Hickory	Painted

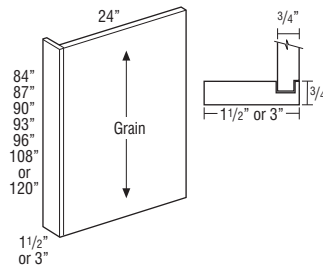

HOMECREST[®]

C A B I N E T R Y

NEW PRODUCTS & UPDATES

Welcome to Homecrest[®].

Like any artist, you need the right tools to create your award-winning designs. With Homecrest's 2023 launch, you'll find thoughtful portfolio enhancements that add new possibilities to your palette. New products and enhancements will assist you in satisfying the unique design needs of each of your customers.

We can't wait to see what you'll design next!

Don't miss out on the opportunity to have your design work featured on MasterBrand's website, social media, literature and beyond. We want to promote you by spotlighting your design talent. Submission is simple via the Homecrest Brand Portal on mb1touch.com.

SHARE YOUR HOMECREST DESIGNS WITH US BY SCANNING THE QR CODE.

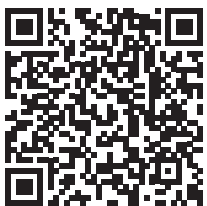

Stay up-to-date on Homecrest at mb1touch.com





Exterior: Rosedale Painted Hardwood Alpine
Island: Rosedale Maple Derby
Office: Kendrick Painted Hardwood Peacock



PURESTYLE™

Homecrest™ offers PureStyle™ for those looking for the beauty of a paint finish with added durability.

The PureStyle wrapped door and drawer front design solution delivers crisp, clean details and a durable, paint-like finish. The added benefits of color consistency paired with the resistance to scratching, fading and surface water mean PureStyle delivers fashion without the fuss.

All doors are mitered construction.

ARBOR

Traditional overlay with simple style. Available in slab and 5-Piece drawer front.

DARWYN

Full overlay with wide rails and clean lines. Available in slab and 5-Piece drawer front.

SEDONA

Full overlay with simple style. Available in slab and 5-Piece drawer front.

WALDRON

Full overlay with unique design details. Available in 5-Piece drawer front.

CHALET (Laminate)

Full Overlay with sleek style. Available with slab drawer front.



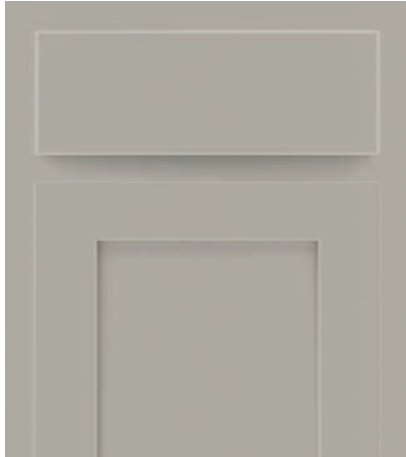

ARBOR
SLAB DRAWER



ARBOR
5-PIECE DRAWER



DARWYN
SLAB DRAWER



DARWYN
5-PIECE DRAWER



SEDONA
SLAB DRAWER



SEDONA
5-PIECE DRAWER



WALDRON
5-PIECE DRAWER

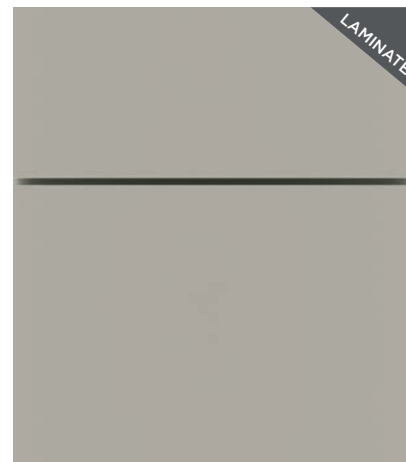

CHALET
SLAB DRAWER



EXCEPTIONAL FINISH.

PureStyle™ features color consistency without the unpredictable variability often seen by various wood types. The surface regularity of PureStyle™ results in a fashionable, clean-lined aesthetic.

Shown on Waldron 5-Piece



ALPINE



ICEBERG



WILLOW



GALAXY



POOLHOUSE



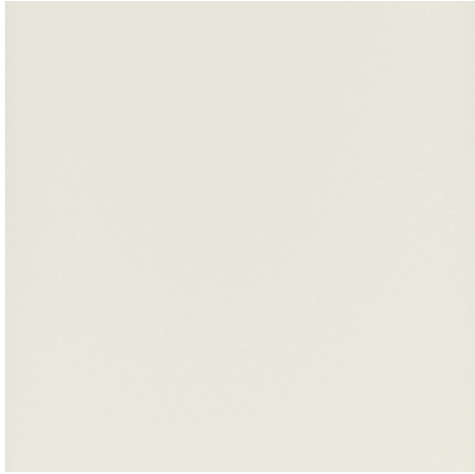

MYSTIC

This new white is a perfect solution for those who prefer a more subdued white. Mystic is a gentle white that pairs well with stains or makes a great stand-alone paint tone.

Available on Painted Hardwood

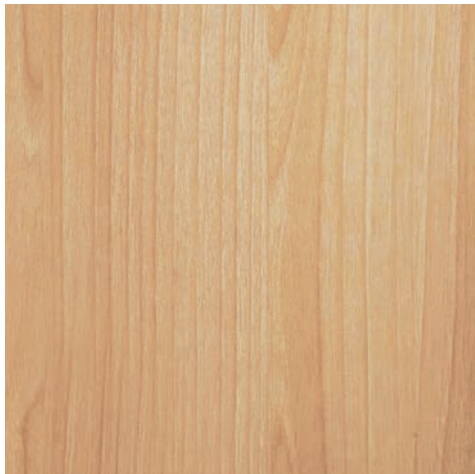

UNFINISHED

Homecrest's Unfinished option is the right choice when final finishing will be done onsite.

Requires APU or PEU upgrade.

When cabinets are finished by an outside source, finish is not covered under warranty. Interiors of cabinets will be natural Maple laminate. For finishable interiors, MIP must be specified.

Available species: Maple, Hickory, Oak, Rustic Hickory



HAVEN COMING SOON!

Haven is a mid-tone muted green that can shift to blue-gray tones offering broad appeal especially as an accent color.

Available on Painted Hardwood

31" TALL WOOD HOOD CHIMNEY

Trends show that wood hoods are the current "it" item to have in the kitchen. Why not choose one that can bring the drama? Homecrest now offers a tall chimney to punctuate rooms with a taller ceiling height.

- Classic Wood Hood Chimney Tall (RHCT)
- Fits with 30", 36", and 42" wood hoods

- RHCT30
- RHCT36
- RHCT42

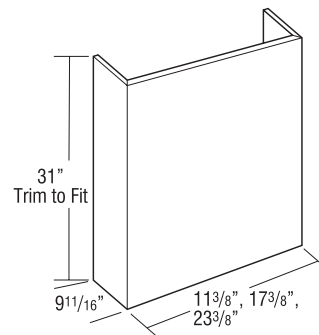

BOOKCASES

A bookcase combines form and function in the home. Serving as both a great design element and a necessary storage feature, a bookcase is a winning addition to most any design. Now, these new Bookcase SKUs offer a cleaner field look with a standard face frame and replace existing Bookcase SKUs.

Wall Furniture Bookcase

- WFBC****

12" Deep Tall Bookcase

- TBC****12

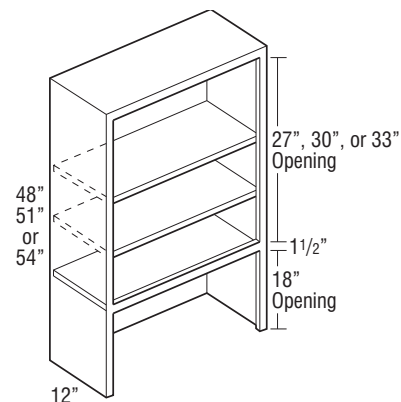

DECORATIVE MOULDINGS

Looking to add extra details to create visual interest and add height to a room? Our wide selection of Decorative Moulding has been expanded to include even more top sellers!

- SCM8
- COTCROWN8



WALL MICROWAVES

Open shelf height is smaller at 15 ¾" to accommodate today's smaller microwaves. Cabinet opening height is larger for additional behind the door storage. It's a win/win creating storage just where you need it.

Wall Microwave Double Door Cabinets

- WMW**36B
- WMW**39B
- WMW**42B

New SKUs will replace existing Wall Microwave with Double Door SKUs.

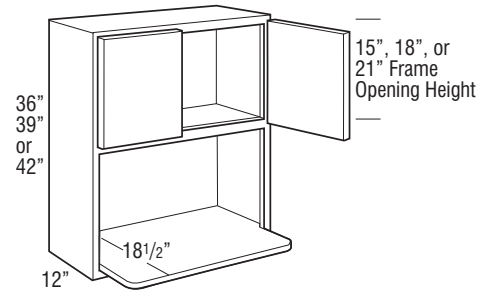

? WHY YOU'LL CARE:

Compact microwaves are here, and your kitchen designs need to accommodate them seamlessly. These new sizes make it easy.

FINISH EXPANSION

ONYX PAINT

Onyx Paint is now available with standard matching laminate Onyx ends. This allows for a perfectly finished design for less cost than a painted panel or skin.



31.5" OVEN & MICROWAVE CABINETS

First up, Homecrest has increased its oven and microwave cabinet offerings to accommodate standard ovens in the most popular sizes. This eliminates room for error with miscuts and speeds along the installation.

All oven configurations are being expanded to include 31.5" widths.

- Single Oven Cabinet (OSB)
- Double Oven Cabinet (OD)
- Double Oven Cabinet, Deep Drawer (OD**DD)
- Oven Microwave Cabinet, Deep Drawer (OMC**DD)

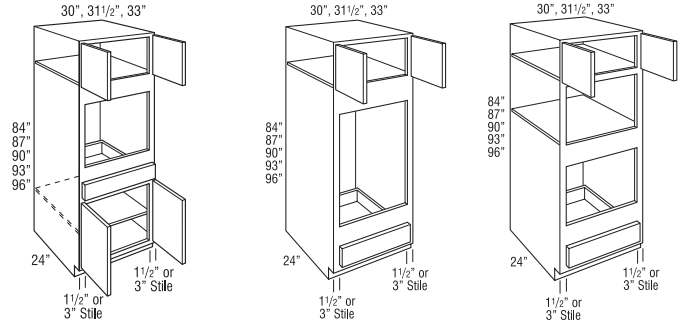

ADDITIONAL FILLER SIZES

Building on the portfolio of existing filler sizes, these options are now available.

- F348
- F351
- F354
- F357
- F360



WHY YOU'LL CARE:

Tall is trending. With the demand for taller kitchen cabinet designs, additional filler sizes are a must.

TEXTURED GLASS

We are expanding the Textured Glass Offering to include all models with cut for glass (CG) to make it easier for you to design!

- W9: 30", 33", 36", 39", 42"
- W12: 12"
- W24 (butt): 12"
- W42 (4 door): 12"
- W45 (4 door): 12"
- W48 (4 door): 12"

GLASS	CABINET HEIGHT										
	12"	15"	18"	21"	24"	27"	30"	33"	36"	39"	42"
Cabinet Width											
W9							✓	✓	✓	✓	✓
W12	✓	✓	✓	✓	✓	✓	✓	✓	✓	✓	✓
W15	✓	✓	✓	✓	✓	✓	✓	✓	✓	✓	✓
W18	✓	✓	✓	✓	✓	✓	✓	✓	✓	✓	✓
W21	✓	✓	✓	✓	✓	✓	✓	✓	✓	✓	✓
W24	✓	✓	✓	✓	✓	✓	✓	✓	✓	✓	✓
W24 (butt)	✓	✓	✓	✓	✓	✓	✓	✓	✓	✓	✓
W27 (butt)	✓	✓	✓	✓	✓	✓	✓	✓	✓	✓	✓
W30 (butt)	✓	✓	✓	✓	✓	✓	✓	✓	✓	✓	✓
W33 (butt)	✓	✓	✓	✓	✓	✓	✓	✓	✓	✓	✓
W36 (butt)	✓	✓	✓	✓	✓	✓	✓	✓	✓	✓	✓
W39 (CS)	✓	✓	✓	✓	✓	✓	✓	✓	✓	✓	✓
W42 (CS)		✓	✓	✓	✓	✓	✓	✓	✓	✓	✓
W45 (CS)			✓	✓	✓	✓	✓	✓	✓	✓	✓
W48 (CS)			✓	✓	✓	✓	✓	✓	✓	✓	✓
W42 (4 door)	✓	✓									
W45 (4 door)	✓	✓									
W48 (4 door)	✓	✓									
WD	✓	✓	✓		✓	✓	✓	✓	✓	✓	✓

GLASS OPTION EXPANDED TO OVEN CABINETS

Homecrest makes it easier to create a stylish glass run by eliminating exceptions in the portfolio.

- Allow glass option on the top doors of all Narrow Stile Oven Cabinets.
- Eliminates inconsistency in availability



WHY YOU'LL CARE:

Glass cabinet doors add interest and depth to the design and can make the space feel larger.

DESIGN ENHANCEMENTS

SMOOTH OPERATOR

SofTouch™ is now standard across Homecrest in wall spice pull-outs and with the interior wire pull-out and roll tray components within Base SuperCabinets™.

- BSC30RTR
- BSC30RTL
- BSC36PRP



WHY YOU'LL CARE:

Research shows that consumers consider soft-close a must-have feature.

WALL SPICE PULL-OUT

- WSP930
- WSP1230
- WSP933
- WSP1233
- WSP936
- WSP1236
- WSP939
- WSP1239
- WSP942
- WSP1242

DISCONTINUATIONS

Refer to the Product Discontinuation Notice on 1Touch for a complete list of discontinued products and replacements.

HOMECREST®

C A B I N E T R Y



**LEARNING
LIBRARY**

Take advantage of the MasterBrand eLearning Library available through mb1touch.com. This interactive training platform offers Homecrest training modules for you to access on-demand, 24/7/365. You can help shape the library of content by reaching out and sharing the training topics that you are seeking. Take a few minutes now to freshen up on your product knowledge!

EMAIL YOUR SUGGESTIONS TO MBMARKETING@MASTERBRAND.COM.

Waldron PureStyle™ Alpine

TABLE OF CONTENTS

Index	A-E
Nomenclature Chart	F
Characteristics	1
Policies	2
Door Styles	3-17
Finish Process and Characteristics	18
Finish Availability	19-21
Construction Specifications	22
Compatible Modifications	23
Construction Options	24
Drawer, Roll Tray, and Hinge Options	25
Drawer Front Options	26
Modifications	27-34
Specialty Doors	35-36
Glass Inserts	37
Custom Choice™ Cabinetry	38-43
Cabinet Dimensions	44-50
Design Checklist	51
NKBA Guidelines	52-53
Wall Cabinets	54-89
Base Cabinets	90-111
Universal Access Cabinets	112-113
Tall Cabinets	114-127
Other Rooms Cabinets	128-132
Vanity Cabinets	133-144
Fillers	145-148
Appliance Panels	149
Panels & Skins	149-153
Moulding	154-160
Valances	161
Embellishments	162-165
Decorative Corbels & Shelf Supports	166
Decorative Hardware	167-171
Accessories & Parts	172-174
Roll Trays	175
Stain, Paint, & Touch-up Tools	175
Guide Kits and Parts	176
Hinges	177
Parts	177
Doors, Drawer Fronts, & Drawers	177
Custom Doors	178-179
Paint Finish Awareness Agreement	180
Rustic Hickory Description Agreement	181

Description	Code	Page Number
11 1/2" Arts & Crafts Bracket	JBRACKETART	166
11 1/4" Snack Bar Support	SBS	166
13" Large Scroll Corbel	LGCORBEL	166
3" Wide Corner Filler	CWF	145
3" Wide Fillers	F, F.FH, UF	145
30" SuperCabinet™	BSC..RTL, BSC..RTR	110
36" SuperCabinet™	BSC..PRP	110
5" Old World Corbel	CORBLOWD	166
6" Wide Fillers	F, F.FH, UF	145
9" Art Corbel	CORBELART	166
9" Classic Revival Corbel	CORBELCR	166
9" Mission Corbel	CORBELMIS	166
Angle Base	AB	105
Angle End Base	AEB	105
Angled Corner Sink Front Bottom	ACSF	100
Angled Plain 3" Wide Reversible Fillers	BLVDFF	148
Arched Valance	AV	161
Asymmetrical Base Easy Reach	BER	103
Asymmetrical Super Susan	BC..SS	104
Asymmetrical Wall Corner Easy Reach Cabinet	WCER	78
Base Built-in Microwave Cabinet w/Drawer	BBMWD	98
Base Cabinet w/Mixer Lift	B..BFHMIX, B..FHMIX	111
Base Corner	BC	101
Base Corner Peninsula	BCP..B	110
Base Corner Peninsula w/Full Height Door	BCP..BFH	110
Base Corner Super Susan w/Wood Shelves	BC..SS	104
Base Double Door	B, B..B	90
Base Double Door w/Roll Trays	B..BRT, B..RT	92
Base Drop-in Range Cabinet	B..BDR	99
Base Easy Reach	BER	103
Base Lazy Susan Corner w/ Full Height Door & Lazy Susan (w/Center Hinge Door)	BLS	102
Base Microwave Cabinet w/Drawer	BMWD	98
Base Microwave Cabinet w/Standard Drawer	BMWSD	99
Base Oven Cabinet	BO	99
Base Pantry Pull-out	B..PO	109
Base Pull-out Filler, Overlay	BPOF..OV	111
Base Pull-out Filler, Plain	BPOF..PL	111
Base Single Door	B	90
Base Single Door w/Roll Trays	B..RT	92
Base Utensil Pantry Pull-out	BUPP	109
Base Utensil Pantry Pull-out w/Knife Block	BUPPKB	109
Base Wastebasket	BWB	108
Base Wastebasket, Full Height	BWB..FH	108
Base Wine Cubby	BWC	109
Base w/Roll-out Tray Divider	B..TDRO	93
Base w/Tray Divider	TD	93
Baseboard	BBM	157
Baseboard Shaker	BBMSH	157
Batten	BATTEN	157
Batten Small	SM	157
CabMat™	CABMAT	172
CabMat™ Vanity	CABMATV	172
Canopy Square Wood Hood	WHCS	88
Cap Moulding	CAPM, SOFFITA, SOFFITE	159
Chair Rail	CHAIR	157
Classic Tall Crown	CLTCROWN	154
Column Box Fillers	CB..PL	148

Description	Code	Page Number
Cooking Utensil Divider	CUDD	172
Corner Diagonal Base	CDB	102
Corner Diagonal Base w/ Full Height Door & Wood Shelves	CDB..SS	102
Corner Diagonal Sink Base	CDSB	100
Corner Sink Front	CSF	100
Cornice Tall Crown	COTCROWN	154
Country Sink Base	CNTYSB, CNTYSB..B	96
Country Sink Base, 27" Deep	CNTYSB, CNTYSB..B	97
Country Sink Base w/CabMat™	CNTYSB..BCM	97
Cove Crown	COVECROWN	154
Cross Grain Veneer Back Skin	L..X, W..BP, W..X	150
Custom Doors, No Hinge Routing	DADOOR	178
Custom Doors w/Hinge Routing	DOORHNG	179
Cutlery Divider Wood Tiered Drawer	WTCD	172
Cutlery Insert Wood Organizer	CIW	172
Decorative Arch Valance	DAV	161
Decorative Door Panel Kit — Base End	BDOP	153
Decorative Door Panel Kit — Tall End	TDOP	153
Decorative Door Panel Kit — Wall End	WDOP	152
Decorative Hardware	KNOB, PULL	167-171
Decorative Supports — Craftsman Foot	JCRAFTFOOT	165
Decorative Supports — English Bar Column	ENGBARCOLUMN	162
Decorative Supports — English Country Leg	JENGNTYLEG	162
Decorative Supports — English Island Column	ENGLISLCOLUMN	162
Decorative Supports — Estate Leg	JESTATELEGS	162
Decorative Supports — Island Leg, 2-Sided or 4-Sided	2SISLLEG, 4SISLLEG	163
Decorative Supports — Island Leg Tapered	ISLEGTPRD	163
Decorative Supports — Kensington Bun Foot	JCRBUNFOOT	165
Decorative Supports — Lille Foot	LIFOOT	165
Decorative Supports — Metro Column	METISLCOLUMN	163
Decorative Supports — Mission Leg	DLEGMISSION	163
Decorative Supports — Spool Leg	SPLEG	164
Decorative Supports — Square Island Leg	SOISLLEG	164
Decorative Supports — Tapered Leg	TAPLG	165
Decorative Supports — Toekick Tulip Foot	TKTLFOOT	165
Decorative Supports — Tulip Foot	TLFOOT	165
Decorative Supports — Turned Post	TURNEDPOST	164
Designer Square Wood Hood	DRH..S	86
Designer Wood Hood Chimney	RHC, RHCT	86
Desk Double File Drawer Base	DDFD	129
Desk Height Door Drawer Base	DHB, DHB..B	128
Desk Height Drawer Base	3DHBD	129
Desk Height File Drawer Base	DHFD	129
Dishwasher End Panels	DWEP, DWEP..FPE, DWEP..WD	149
Double Oven Cabinet	OD	122
Double Oven Cabinet, Deep Drawer	OD..DD	124
Double Oven Cabinet, Deep Drawer, Narrow Rail	OD..DDN	125
Double Oven Cabinet, Narrow Rail	OD..N	123
Drawer Guide Back Sockets	BKSOCKETFDRW, BKSOCKETPG, BKSOCKETRTPG	176
Drawer Guide Box Locking Clips	PG..LOCKCLIP, PG..LOCKCLPNRW, PGLOCKCLIP, PGLOCKCLIPNRW	176
End Panel Skins	LBEP, LTEP, LWEP, WBEP, WTEP, WWEP	149

Description	Code	Page Number
End Panels	LSP, SE, SE..WD, SP	151
Exterior Shelves, 12" Deep	ES	173
False Panel Clips	.FIXEDFRTCLIP, PFIXEDFRTCLIP	176
Finished Back Skins	L, W	150
Floating Shelves	FS	84
Four Drawer Base	4BD	107
Four Drawer Base w/Wood Tiered Cutlery Divider Drawer	4BD..WTCD	108
Full Depth Interior Shelves	.SK	173
Full Height Base Double Door	.B..BFH, B..FH	91
Full Height Base Single Door	B..FH	91
Full Height Base w/Tray Divider	.TD..FH	93
Furniture Base	FB	157, 159
Furniture Drawer	FD	130
Furniture Drawer Window Bench	FDWB	130
Furniture Valance	FV	161
Glass Shelf Kit, 12" Deep	.GSK, GSKWD	173
Guide Kits & Parts	.DGKIT..DDFD, DGKIT..FDRW, DGKIT..PG, DGKIT..RTF, DGKIT..RTPG	176
Hinge Angle Restriction Clip	.INTGHRSTRCLIP	177
Hinge Shim	.HINGESPACER	177
Hinges	.BERDR-DRHINGE, BERDR-FRMHINGE, FO..HINGE, INTGHFOHINGE, INTGHPOHINGE, INTGHSRFMTHG, MIRRORHINGE, PO..HINGE, SURFMHINGE	177
Insert Crown	.INSCROWN	154
Inside Corner	.ISC	160
Large Crown	.LCROWN	154
Large Straight Angle Crown	.LSACROWN	155
Library Moulding	.LIBRARY	157
Light Baffle	.LB	159
Light Rail Moulding	.LRM	159
Linen Storage Cabinet	.LT, LT..BH	142
Linen Utility w/Hamper	.L..BH	142
Medicine Cabinet	.TV	144
Medium Straight Angle Crown	.MSACROWN	155
Mirror Frame	.MRM	157
Miscellaneous Parts	.BRKOFFSCREW, DOORBUMPER, GLASSRETCLIP, INSTLSCREW, SHELFLIP	177
Ogee Edge	.OJM	158
Outside Corner	.OCM	160
Outside Corner 135°	.OSC	160
Outside Corner Small	.SOCM	160
Oven Installation Kit	.OVENINSTALLKIT	174
Oven Microwave Cabinet, Deep Drawer	.OMC..DD	126
Oven Microwave Cabinet, Deep Drawer, Narrow Rail	.OMC..DDN	127
Overlay Filler, 2 1/2" Wide	.OL	146
Overlay Filler, 5 1/2" Wide	.OL	147

Description	Code	Page Number
Overlay Filler for Modified Full Overlay, 2 1/2" Wide	.OL..MFO	146
Overlay Filler for Modified Full Overlay, 5 1/2" Wide	.OL..MFO	147
Pegged Dish Organizer	.PDO, PDOPOSTS	174
PURE&SIMPLE™ Cabinet Care Kit	.CABCLEANKIT	175
Quarter Round	.QRM	160
Refrigerator Panels w/Filler Attached	.LREP, WREP	152
Refrigerator Panels w/Filler Attached & Furniture Ends	.WREP..FPE	152
Removable Vanity Sink Base	.RVWS..B	113
Roll Tray Plug In Brackets	.RTFSPACER, RTPGSPACER	176
Roll Trays	.RTF, RTF..FW, RTPG, RTPG..FW	175
Shaker Crown	.LSHAKER, NSHAKER	155
Shiplap Tapered Wood Hood	.JWHSHIPT	87
Shiplap Wood Hood Chimney	.JWHSHIPCH	87
Shoe - Convex Inside Corner	.SHM	160
Simple Tapered Wood Hood	.WHSMT	87
Simple Wood Hood Chimney	.WHSMC	87
Single Bead	.SB	158
Single Door Medicine Cabinet	.MC	143
Single Oven Cabinet	.OSB	120
Single Oven Cabinet, Narrow Rail	.OSB..N	121
Sink Base	.SB, SB..B	94
Sink Base, 27" Deep	.SB, SB..B	94
Sink Base, Single Door	.SB	93
Sink Base SuperCabinet™ w/Tilt-out Trays	.SB..STS	98
Sink Base SuperCabinet™ w/Tilt-out Trays & CabMat™	.SB..STSCM	98
Sink Base w/CabMat™	.SB..BCM	94
Sink Base w/Tilt-out Trays	.SB..BST, SB..ST	95
Sink Base w/Tilt-out Trays & CabMat™	.SB..BSTCM	95
Sink Base w/Tilt-Out Trays, 27" Deep	.SB..BST, SB..ST	96
Small Cove Crown	.SMCOVECROWN	155
Small Crown	.SCM	155
Small Light Rail Moulding	.SMLR	159
Small Scribe	.SCRIBE	158
Soffit Trim Moulding	.TSTM	158
Solid-wood Large Crown	.SWLCRM	155
Solid-wood Small Crown	.SCROWN	155
Solid-wood Victorian Crown	.SWVCRM	156
Spice Rack — Pull-down	.SPD	174
Square Flat Panel Wood Hood	.WHSFP	86
Stacked Diagonal Wall	.STWD	77
Stacked Wall Cabinets Double Door	.STW, STW..B	68-72
Stacked Wall Cabinets Single Door	.STW	68-72
Stain, Paint, & Touch-up Tools	.GLAZEPEN, MTUK, PAINTQUART, SPRAYPAINT, SSCCLEAR, STAINQUART, TK	175
Starter Moulding — Soffit Filler Moulding	.SFM	156
Starter Moulding — Starter Moulding	.STR	156
Starter Moulding — Starter Moulding Shaker	.STRS	156
Straight Angle Crown	.SACROWN	156
Straight Batten Wood Hood, 24" or 30" High	.WHSBATTEN	88
Straight Batten Wood Hood, 36" High	.WHSBATTEN	88
Straight Heat Shields	.OHS, OHSS	174
Straight Valance	.SV	161
Tall Bookcase	.TBC	132
Tall Crown	.SWTCRM	156
Tapered Wood Hood	.TWH	86

Description	Code	Page Number
Three Drawer Base	3BD, BD..D	107
Three Drawer Base w/Wood Tiered Cutlery Divider Drawer	3BD..WTCD	107
Tilt-out Trays, Plastic	TOT	174
Toekick Cap	TKC	158
Toekick Overlay	LTO, WTO	153
Touch Latch	TOUHLATCH	171
Traditional Countertop Edge	TCM	158
Tray Divider Kit	WTD	174
Tray Roll-out Divider	TDRO	174
Triple Bead Edge	TB	158
Triple Bead Pilaster	TBP	158
Two Drawer Base	2BD	106
Two Drawer Base Drop-in Range	2BD..DR	106
Two Drawer Base w/Roll Tray	2BD..RT	106
Under Counter Drawer	UCD, UCDS	130, 143
Under Counter Drawer, Trimmable	UCDT	130, 143
Universal Access Base Corner Super Susan w/Wood Shelves	BC..SS	113
Universal Access Base, Double Door	B..B	112
Universal Access Base Microwave w/Deep Drawer	BMWD	113
Universal Access Base, Single Door	B	112
Universal Access Sink Base	SB..B	112
Universal Access Three Drawer Base	3BD	112
Utility	U, U..B	114-117
Utility w/Roll Trays	U..BRT, U..RT	118, 119
Valley Forge	VFR	159
Vanity Base, Double Door w/Drawer	VB..B, VB..BBH	134, 135
Vanity Base, Single Door w/Drawer	VB, VB..BH	134, 135
Vanity Bowl Base	VBB, VBB..B, VBB..BBH, VBB..BH	136, 137
Vanity Bowl Base w/False Panel	VB..D, VB..DLBH, VBB..D, VBB..DBH, VBB..DLBH	137, 139
Vanity Bowl Base w/Six Drawers & False Panel	VBB..D, VBB..DBH	138, 140
Vanity Desk Legs	DL, VDL	153
Vanity Drawer Base	VDB, VDB..BH	141
Vanity Drawer Base w/False Panels	VDB..FP, VDB..FPBH	140
Vanity Four Drawer Base	4VBD..BH	136
Vanity Mirror	VM	144
Vanity Sink Base w/False Panel	VSB..B, VSB..BBH	133, 134
Vanity Sink Base w/False Panels	VSB, VSB..BH	133, 134
Vanity Three Drawer Base	VBD, VBD..BH	135
Vanity Wall	W..B	143
Vanity Wall Mirror Cabinet	VWM	144
Vanity Wall Sink	VWS	113
Wall Appliance Garage Doors	WAGD, WAGD..B	82
Wall Boutique	WB..B	143
Wall Built-in Microwave Double Door Cabinet	WBMW	81
Wall Corner Double Door	WC	73
Wall Corner Easy Reach	WCER	78
Wall Corner Single Door	WC	73, 74
Wall Diagonal	WD	75, 76
Wall Diagonal Appliance Garage Doors	WDAGD	82
Wall Diagonal w/Lazy Susan	WD..S	76
Wall Double Door	W, W..B, W..CS	54-66
Wall End Cabinet Single Door	WEC	79
Wall Furniture Bookcase	WFBC	131
Wall Message Center Cabinet,	WMC	79
Wall Microwave Cabinet,	MW	80

Description	Code	Page Number
Wall Microwave Double Door Cabinet	WMW..B	80
Wall Organizer	WO	85
Wall Outside End Shelf, Square Top, Square Bottom	WOC..STSB	82
Wall Pull-out Filler, Overlay	WPOF..OV	83
Wall Pull-out Filler, Plain	WPOF..PL	83
Wall Single Door	W	54-66
Wall Spice Pull-out	WSP	81
Wall Three Drawer Double Door	W3DB	67
Wall Three Drawer Single Door	W3D	67
Wall Top Hinge Single Door	WTH	55-57, 59
Wall Wine Cubby	SQWC	84
Wall Wine Rack	WR	84
Wine Glass Holders	SWR	174
Wine Storage Cabinets	WSC	83
Wood Hood Blower, 400 CFM	BLOWER	89
Wood Hood Blower, 600 CFM	BLOWER	89
Wood Hood Interior Ductwork Conversion Kit	CONVERSION, FILTERCHAR	89
Wood V-grooved Beaded Skin	W..BB	150

Code	Page Number
2BD	106
2BD..DR	106
2BD..RT	106
2SISLLEG	163
3BD	107, 112
3BD..WTCD	107
3DHBD	129
4BD	107
4BD..WTCD	108
4SISLLEG	163
4VBD..BH	136
AB	105
ACSB	100
AEB	105
AV	161
B	90
B..B	90
B..BDR	99
B..BFH	91
B..BFHMIX	111
B..BRT	92
B..FH	91
B..FHMIX	111
B..PO	109
B..RT	92
B..TDRO	93
BATTEN	157
BBM	157
BBMSH	157
BBMWD	98
BC	101
BC..SS	104, 113
BCP..B	110
BCP..BFH	110
BD..D	107
BDOP	153
BER	103
BERDR-DRHINGE	177
BERDR-FRMHINGE	177
BKSOCKETFDRW	176
BKSOCKETPG	176
BKSOCKETRTPG	176
BLOWER	89
BLS	102
BLVDFF	148
BMWD	98, 113
BMWSD	99
BO	99
BPOF..OV	111
BPOF..PL	111
BRKOFFSCREW	177
BSC..PRP	110
BSC..RTL	110
BSC..RTR	110
BUPP	109
BUPPKB	109
BWB	108
BWB..FH	108
BWC	109
CABCLEANKIT	175
CABMAT	172
CABMATV	172
CAPM	159
CB..PL	148
CDB	102
CDB..SS	102
CDSB	100

Code	Page Number
CHAIR	157
CIW	172
CLTCROWN	154
CNTYSB	96, 97
CNTYSB..B	96, 97
CNTYSB..BCM	97
CONVERSION	89
CORBELART	166
CORBELCR	166
CORBELMIS	166
CORBELOWD	166
COTCROWN	154
COVECROWN	154
CSF	100
CUDD	172
CWF	145
DADOOR	178
DAV	161
DDFD	129
DGKIT..DDFD	176
DGKIT..FDRW	176
DGKIT..PG	176
DGKIT..RTF	176
DGKIT..RTPG	176
DHB	128
DHB..B	128
DHFD	129
DL	153
DLEMISSION	163
DOORBUMPER	177
DOORHNG	179
DRH..S	86
DWEP	149
DWEP..FPE	149
DWEP..WD	149
ENGBARCOLUMN	162
ENGISLCOLUMN	162
ES	173
F	145
F..FH	145
FB	157, 159
FD	130
FDWB	130
FILTERCHAR	89
FIXEDFRTCLIP	176
FO..HINGE	177
FS	84
FV	161
GLASSRETCLIP	177
GLAZEPEN	175
GSK	173
GSKWD	173
HINGESPACER	177
INSCROWN	154
INSTLSCREW	177
INTGHFOHINGE	177
INTGHPOHINGE	177
INTGHRSTRCLIP	177
INTGHSRFMTHG	177
ISC	160
ISLEGTPRD	163
JBRACKETART	166
JCRAFTFOOT	165
JCRBUNFOOT	165
JENGCNTYLEG	162
JESTATELEGS	162
JWHSHPCH	87

Code	Page Number
JWHSIPT	87
KNOB	167-171
L	150
L..BH	142
L..X	150
LB	159
LBEP	149
LCROWN	154
LGCORBEL	166
LIBRARY	157
LIFOOT	165
LREP	152
LRM	159
LSACROWN	155
LSHAKER	155
LSP	151
LT	142
LT..BH	142
LTEP	149
LTO	153
LWEP	149
MC	143
METISLCOLUMN	163
MIRRORHINGE	177
MRM	157
MSACROWN	155
MTUK	175
MW	80
NSHAKER	155
OCM	160
OD	122
OD..DD	124
OD..DDN	125
OD..N	123
OHS	174
OHSS	174
OJM	158
OL	146, 147
OL..MFO	146, 147
OMC..DD	126
OMC..DDN	127
OSB	120
OSB..N	121
OSC	160
OVENINSTALLKIT	174
PAINTQUART	175
PDO	174
PDOPOSTS	174
PFIXEDFRTCLIP	176
PG..LOCKCLIP	176
PG..LOCKCLPNRW	176
PGLOCKCLIP	176
PGLOCKCLIPNRW	176
PO..HINGE	177
PULL	167-171
QRM	160
RHC	86
RHCT	86
RTF	175
RTF..FW	175
RTFSPACER	176
RTPG	175
RTPG..FW	175
RTPGSPACER	176
RVWS..B	113
SACROWN	156
SB	93, 94

Code	Page Number
SB..B	94, 112
SB..BCM	94
SB..BST	95, 96
SB..BSTCM	95
SB..ST	95, 96
SB..STS	98
SB..STSCM	98
SBS	166
SCM	155
SCRIBE	158
SCROWN	155
SE	151
SE..WD	151
SFM	156
SHELFCLIP	177
SHM	160
SK	173
SM	157
SMCOVECROWN	155
SMLR	159
SOCM	160
SOFFITA	159
SOFFITE	159
SP	151
SPD	174
SPLG	164
SPRAYPAINT	175
SOISLLEG	164
SQWC	84
SSCLEAR	175
STAINQUART	175
STR	156
STRS	156
STW	68-72
STW..B	68-72
STWD	77
SURFMHINGE	177
SV	161
SWLCRM	155
SWR	174
SWTCRM	156
SWVCRM	156
TAPLG	165
TB	158
TBC	132
TBP	158
TCM	158
TD	93
TD..FH	93
TDOP	153
TDRO	174
TK	175
TKC	158
TKTLFOOT	165
TLFOOT	165
TOT	174
TOUCHLATCH	171
TSTM	158
TURNEDPOST	164
TV	144
TWH	86
U	114-117
U..B	114-117
U..BRT	118, 119
U..RT	118, 119
UCD	130, 143
UCDS	130, 143

Code	Page Number
UCDT	130, 143
UF	145
VB	134
VB..B	134
VB..BBH	135
VB..BH	135
VB..D	137
VB..DLBH	139
VBB	136
VBB..B	136
VBB..BBH	137
VBB..BH	137
VBB..D	138
VBB..DBH	139, 140
VBB..DLBH	139
VBD	135
VBD..BH	135
VDB	141
VDB..BH	141
VDB..FP	140
VDB..FPBH	140
VDL	153
VFR	159
VM	144
VSB	133
VSB..B	133
VSB..BBH	134
VSB..BH	134
VWM	144
VWS	113
W	54-66, 150
W..B	54-66, 143
W..BB	150
W..BP	150
W..CS	56
W..X	150
W3D	67
W3DB	67
WAGD	82
WAGD..B	82
WB..B	143
WBEP	149
WBMW	81
WC	73, 74
WCER	78
WD	75, 76
WD..S	76
WDAGD	82
WDOP	152
WEC	79
WFBC	131
WHCS	88
WHSBATTEN	88
WHSFP	86
WHSMC	87
WHSMT	87
WMC	79
WMW..B	80
WO	85
WOC..STSB	82
WPOF..OV	83
WPOF..PL	83
WR	84
WREP	152
WREP..FPE	152
WSC	83
WSP	81

Code	Page Number
WTCD	172
WTD	174
WTEP	149
WTH	55-59
WTO	153
WWEP	149

BRAND

HC Homecrest

STYLE

ARBR Arbor
 BSHP Bishop
 BXLY Bexley
 CHAL Chalet
 DRWN Darwyn
 DOVR Dover
 FYFR Fyfer
 HLND Highland
 JPLN Joplin
 KDRK Kendrick
 KENO Kenosha
 LTNR Lautner
 PIPR Piper
 RSDL Rosedale
 SDNA Sedona
 WALD Waldron
 WLZN Welzin
 WXFD Wexford

WOOD SPECIES

H..... Hickory
 L..... Laminate/PureStyle™
 M..... Maple
 O..... Oak
 PT..... Painted Hardwood
 RH..... Rustic Hickory

FINISH

ANC Anchor
 BUC Buckboard
 DRB Derby
 FLO Fallow
 KAR Karoo
 MNE Mane
 NAT Natural
 POR Porter
 TER Terrain
 TLS Trellis
 UNF Unfinished
 WRN Wren

PAINT FINISH

ALP Alpine
 GLX Galaxy
 HVN Haven*
 ICE Iceberg
 MYS Mystic
 ONX Onyx
 PCK Peacock
 PHS Poolhouse
 VAN French Vanilla**
 WIL Willow

FINISH WITH GLAZE

ANCBR Anchor w/Brownstone
 ANCEB Anchor w/Ebony
 BUCBR Buckboard w/Brownstone
 BUCEB Buckboard w/Ebony
 DRBBR Derby w/Brownstone
 DRBEB Derby w/Ebony
 FLOBR Fallow w/Brownstone
 FLOBE Fallow w/Ebony
 KARBR Karoo w/Brownstone
 KAREB Karoo w/Ebony
 MNEBR Mane w/Brownstone
 MNEEB Mane w/Ebony
 NATBR Natural w/Brownstone
 NATEB Natural w/Ebony

FINISH WITH GLAZE continued

PORBR Porter w/Brownstone
 POREB Porter w/Ebony
 TERBR Terrain w/Brownstone
 TERE Terrain w/Ebony
 TLSBR Trellis w/Brownstone
 TLSEB Trellis w/Ebony
 WRNBR Wren w/Brownstone
 WRNEB Wren w/Ebony

PAINT FINISH WITH GLAZE

ALPBR Alpine w/Brownstone
 ALPEB Alpine w/Ebony
 GLXBR Galaxy w/Brownstone
 GLXEB Galaxy w/Ebony
 HVNBR Haven w/Brownstone*
 HVNEB Haven w/Ebony*
 ICEBR Iceberg w/Brownstone
 ICEEB Iceberg w/Ebony
 MYSBR Mystic w/Brownstone
 MYSEB Mystic w/Ebony
 ONXBR Onyx w/Brownstone
 ONXEB Onyx w/Ebony
 PCKBR Peacock w/Brownstone
 PCKEB Peacock w/Ebony
 PHSBR Poolhouse w/Brownstone
 PHSEB Poolhouse w/Ebony
 VANBR French Vanilla w/Brownstone**
 VANE French Vanilla w/Ebony**
 WILBR Willow w/Brownstone
 WILEB Willow w/Ebony

STANDARD CONSTRUCTION

LE Lamine Ends

CONSTRUCTION UPGRADES

APU 1/2" All-plywood Unfinished Ends
 PEU 1/2" Plywood Ends Unfinished

DRAWER OPTIONS

FDRW Furniture Board Drawer
 WRDW Wood Dovetail Drawer w/SofTouch™ Guide

ROLL TRAY OPTIONS

RTPG Wood Dovetail Roll Trays w/SofTouch™ Guide

STANDARD HINGE

INTGH Integrated SofTouch™ Hinge

HINGE OPTIONS

NSCH Non SofTouch™ Hinge

DRAWER FRONT OPTIONS

DFF5PC Drawer Front Flat 5-piece

END PANEL MODIFICATIONS

AUTHB Authentic Ends Both
 AUTHL Authentic End Left
 AUTHR Authentic End Right
 FPFB Furniture Finished Plywood Ends

BOX MODIFICATIONS

ACS Appliance Cut-out, Single
 CBO Cabinet Box Only
 CCO Cabinet Case Only
 CFNT Cabinet Front Only
 CFP Cabinet False Panel
 CFRMO Cabinet Frame Only
 CND Cabinet with No Door, with Drawer
 EXL Extended Stile Left
 EXR Extended Stile Right
 ID15 Increased Depth to 15"

BOX MODIFICATIONS continued

ID18 Increased Depth to 18"
 ID21 Increased Depth to 21"
 ID24 Increased Depth to 24"
 ID27 Increased Depth to 27"
 ID30 Increased Depth to 30"
 P Peninsula
 RD6 Reduced Depth to 6"
 RD9 Reduced Depth to 9"
 RD12 Reduced Depth to 12"
 RD15 Reduced Depth to 15"
 RD18 Reduced Depth to 18"
 RD21 Reduced Depth to 21"
 RD24 Reduced Depth to 24"
 RD27 Reduced Depth to 27"

OVERLAY MODIFICATION

FULL Full Overlay
 MFO Modified Full Overlay

INTERIOR MODIFICATIONS

FD Full Depth Shelf
 MI Matching Interior

TOEKICK MODIFICATIONS

ADDTK Add Toekick
 FTK Flush Toekick
 FTKAV Flush Toekick Arch
 FTKFV Flush Toekick Furniture
 RECTKALL Island Toekick
 RECTKBK Recessed Toekick Back
 RECTKL Recessed Toekick Left
 RECTKR Recessed Toekick Right
 VTK Void Toekick

SPECIALTY DOORS

CG Cut-for-glass Door
 MD Mullion Door

*Haven is Coming Soon.

**French Vanilla will be available through April 2024.

NOTES

CHARACTERISTICS

Wood

No matter which species you choose for your new kitchen or bath cabinetry, please keep in mind that no two pieces of wood are exactly the same. Stains are likely to exaggerate the difference between open and closed grains and other markings in wood. Grain variation and color change should be expected. As hardwood ages, it will darken when exposed to different types of light. Color differences or changes in wood can also be caused by exposure to harsh chemicals, extreme heat or moisture. Additionally, wood species exhibit other defining characteristics, such as mineral deposits/streaks, knots, sap runs, pin holes and wormholes. These markings make the wood unique and contribute to its enduring beauty.

Hickory is a strong, heavy hardwood known for distinctive graining patterns. Contributing to its dramatic appearance is a wide variation in color and streaking, ranging from white to dark brown. This contrast in color can appear in a single door panel. Hickory also contains random knots and wormholes that further contribute to a varied appearance. These exaggerated characteristics are to be expected and are considered desirable in hickory cabinetry.

Maple is a close-grained hardwood that is predominately white to creamy-white in color, with occasional reddish-brown tones. While maple typically features uniform graining as compared to other wood species, characteristic markings may include fine brown lines, wavy or curly graining, bird pecks and mineral streaks. These traits are natural and serve to enhance maple's natural beauty.

Oak is a strong, open-grained hardwood that ranges in color from white to pink and reddish tones. Streaks of green, yellow and even black may appear due to mineral deposits. Oak may also contain wormholes and wild, varying grain patterns. This distinct graining is considered a desirable quality.

Painted Hardwood finishes combine hardwoods and engineered materials including solid-wood, engineered materials—such as medium density fiberboard (MDF) and high density fiberboard (HDF)—and similar composite materials providing a smoother surface for painting and superior stability, consistency, and durability.

Rustic Hickory is a strong, heavy hardwood known for distinctive graining patterns. Color will vary from nearly white to dark brown, with wild flowing grain patterns and dramatic color variations. Rustic Hickory can have a fine uniform grain to large knots appearing black and brown in color of various shapes and sizes, sapwood, mineral and some checking. Cabinet doors and drawer fronts will be the only items that will feature rustic characteristics.

Sound Closed Knot (not moveable) — Expected up to approximately 3" in diameter

Sound Knot with Cracks — Expect sound knots with open cracks up to approximately 1" in length

Open Knot (through door) — Expected with open area up to approximately 3/4" in diameter

Unsound Knot (moveable core) — Not to be expected

Worm Holes/Pin Holes (can go through the door) — Can be expected up to 1/4" diameter

Worm Tracks — Can be expected in sizes up to approximately 1/8" wide by 8" long

In keeping with our practice of continuous product improvement and/or to maximize efficiencies, Homecrest Cabinetry may adjust specifications in design and materials as it deems necessary. Where differing materials are utilized, they will be of similar or better quality in keeping with Homecrest Cabinetry's commitment to quality.

Laminate

The surfaces of doors, drawer fronts, and overlay fillers feature laminate materials with an integrated top coat that provides superior beauty, durability, and performance. The core panel material is made of MDF to ensure a consistent and stable product.

A heat shield is required to separate all laminate products from heat producing units to be in compliance with cabinet warranty.

PureStyle™ Laminate

PureStyle™ is an innovative laminate that is applied to a wood or engineered wood substrate. Characteristics include crisp styling, consistent coloration, and abrasion-resistant durability.

These doors offer the durability of a laminate and the beauty of paint while bringing peace of mind to those who care about creating a better environment—both inside and outside of their homes.

PureStyle™ doors can be distinguished from painted cabinets by their picture perfect distribution of satin smooth color on a sleek surface with optimum durability. Trim items will feature a matching painted finish except where noted in product specifications.

A heat shield is required to separate all laminate products from heat producing units to be in compliance with cabinet warranty.

In the Species Availability charts throughout the book, refer to Laminate column for PureStyle™ availability.

POLICIES

Humidification

<https://www.masterbrandcabinets.com/humidification>

Installation Guide

<https://www.homecrestcabinetry.com/cabinet-information-resources/literature-downloads>

Warranty

<https://www.homecrestcabinetry.com/get-started/love-your-space/warranty>

Care and Cleaning

<https://www.homecrestcabinetry.com/get-started/love-your-space/care-and-cleaning>

WOOD DUST WARNING

When cutting, sanding, sawing, or shaping cabinets or wood products, you are likely to generate wood dust. For your own safety, we recommend that you wear a protective mask to prevent breathing wood dust. We also recommend eye protection to avoid injury by flying wood chips or sawdust during cabinet installation.

CERTIFICATIONS

ANSI A161.1

Our products meet or exceed the ANSI A161.1 performance and construction standards for kitchen and vanity cabinets as certified by ICC-ES (International Code Council Evaluation Service). Learn more at [masterbrandcabinets.com/certifications](https://www.masterbrandcabinets.com/certifications).

TSCA Title VI



TSCA Title VI is a U.S. regulation that sets formaldehyde emissions standards for composite wood products, such as hardwood plywood, medium-density fiberboard, and particleboard, as well as products containing them, such as furniture. It requires composite wood products to be tested and certified by EPA-recognized third-party certifiers using specific methods. This federal regulation applies to all states and territories in the U.S. and is identical to the California Air Resources Board (CARB) rule. Learn more at [masterbrandcabinets.com/certifications](https://www.masterbrandcabinets.com/certifications).

CARB Compliance - Formaldehyde Emissions

Homecrest Cabinetry is committed to offering solutions that meet or exceed air emissions rules and regulations. All composite wood products used in the construction of our cabinets, which includes end panels, bottoms, backs, shelves, toekicks and corner blocks, are compliant with emissions limits under EPA TSCA Title VI, CARB Phase 2 and HUD.

Door Style Price Point Reference Chart

Your Homecrest Cabinetry price guide contains charts with prices for each cabinetry product, arranged according to a numerical code. Use the chart below to determine the price code for your preferred cabinetry style.

	Hickory	Maple	Oak	Painted Hardwood	Rustic Hickory	 Laminate	 PureStyle™
Arbor	1	2	1	2	2		2
Bexley	6	7		7			
Bishop		6	4	6			
Chalet		6		6		6	
Darwyn	6	7	6	7	7		7
Dover	7	8	7	8	8		
Fyfer	3	6	3	6			
Highland		8		8			
Joplin		3	2	3			
Kendrick	3	6	3	6			
Kenosha	1	2	1	2			
Lautner	2	3		3			
Piper	6	7	6	7			
Rosedale		7		7			
Sedona	6	7	6	7	7		7
Waldron	6	7	6	7			7
Welzin	7	8	7	8			
Wexford	5	7	5	7	7		

Anywhere you see  will take you directly to this page.

To return to your product page, just click the  button.

OVERLAY SPECIFICATIONS

Traditional Overlay

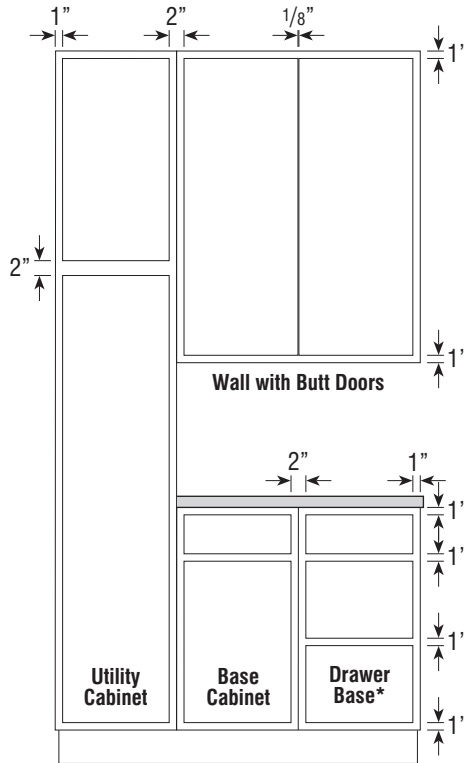

4

DOOR STYLES

Traditional Overlay

The door and drawer fronts overlay the face frame $1/2"$, exposing $1"$ of the frame both on the stile and rail members. Typical wall and base cabinets with a center stile expose $2"$ of that stile.

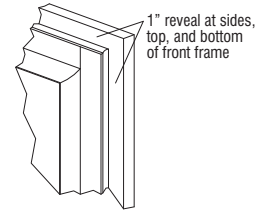

Exceptions on Face Frame Reveals

- Some oven units have $3"$ stiles and $9"$ intermediate rails (designed for universal flexibility of cut-out options) that create various reveals.
- Blind corner wall and base cabinets expose different center stile reveals. Diagonal corners also vary.
- Please see the dimensional charts for oven units and blind bases located in those sections.

*On Traditional Overlay 2BD__ (Two Drawer Bases), reveal above the bottom drawer front is $2"$.

OVERLAY SPECIFICATIONS

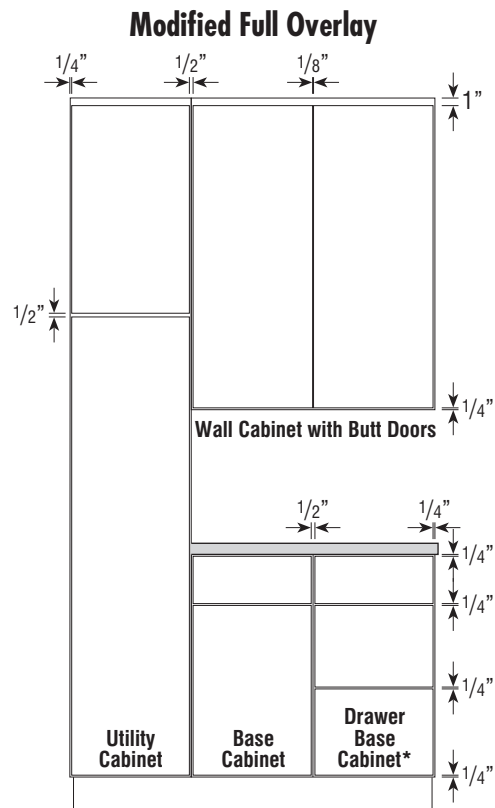
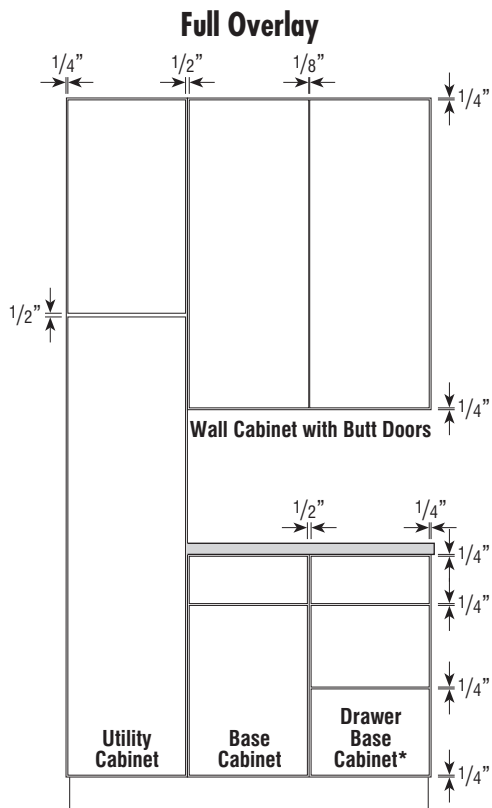

Full Overlay

The door and drawer fronts overlay the frame, exposing 1/4" on the top and bottom rails and right and left stiles of base cabinets. Typical base units with a center stile expose 1/2" of that stile.

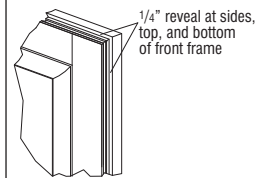

Full Overlay (FULL)

Modified Full Overlay

Wall and Tall Cabinets: The door and drawer fronts overlay the frame exposing 1/4" on the bottom rail and right and left stile. One full inch is exposed on the top rail of wall and tall cabinets. Typical units with a center stile expose 1/2" of that stile.

Base Cabinets: The door and drawer fronts overlay the frame, exposing 1/4" on the top and bottom rails and right and left stiles of base cabinets. Typical base units with a center stile expose 1/2" of that stile.

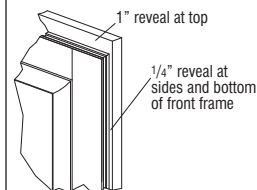

Modified Full Overlay (Wall and Tall)

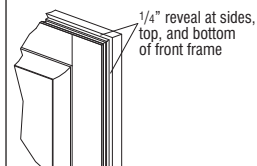

Modified Full Overlay (Base)

*34 1/2" high application shown. On 32" high Full Overlay three drawer applications (drawer bases and sink bases with drawers), the reveal above the bottom drawer front is 1/2".

- One double door center stile cabinet has the same reveal as two single door cabinets.

FULL/MODIFIED FULL OVERLAY DOOR STYLES

6

DOOR STYLES

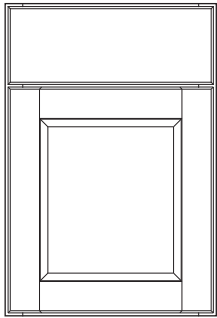

Bexley
(page 9)

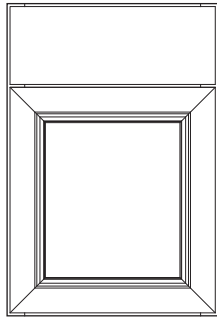

Bishop
(page 10)

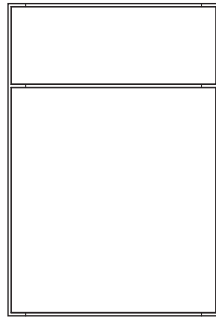

Chalet
(page 10)

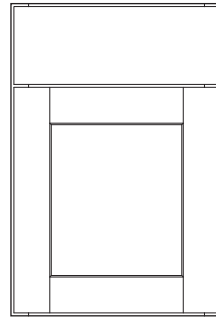

Darwyn (Wood Species)
(page 11)

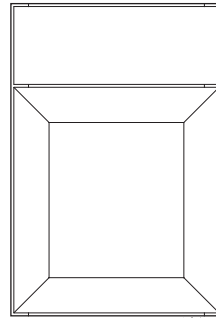

Darwyn (PureStyle™) **NEW**
(page 11)

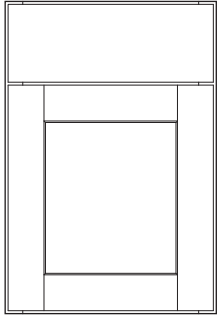

Dover
(page 11)

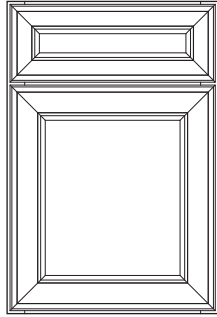

Highland
(page 12)

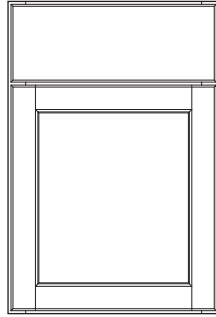

Kendrick
(page 13)

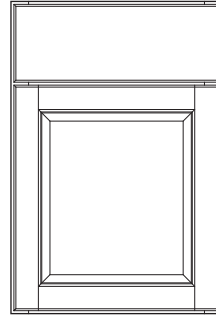

Piper
(page 14)

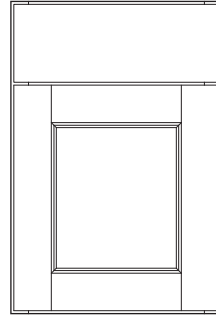

Rosedale
(page 14)

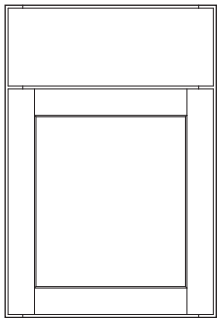

Sedona (Wood Species)
(page 15)

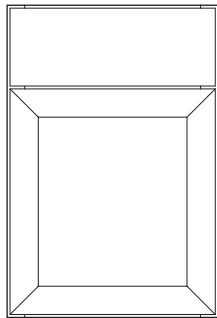

Sedona (PureStyle™) **NEW**
(page 15)

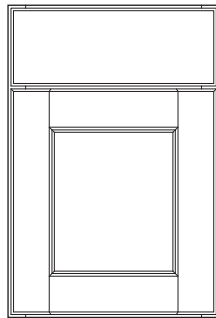

Waldron (Wood Species)
(page 16)

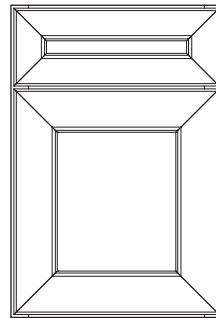

Waldron (PureStyle™) **NEW**
(page 16)

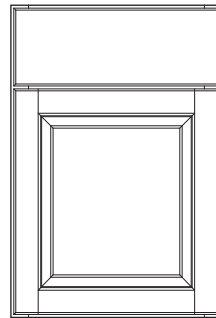

Welzin
(page 17)

TRADITIONAL OVERLAY DOOR STYLES

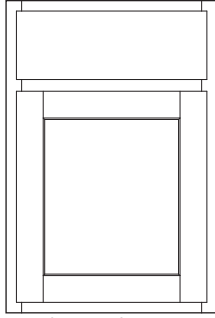

Arbor (Wood Species)
(page 9)

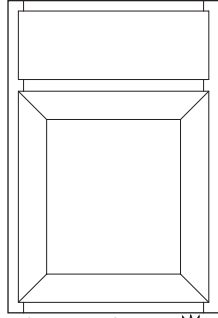

Arbor (PureStyle™)
(page 9) **NEW**

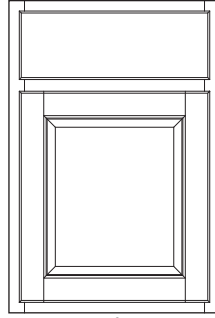

Fyfer
(page 12)

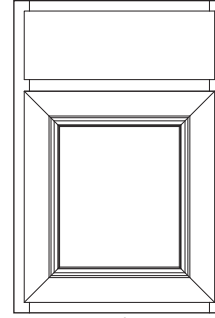

Joplin
(page 12)

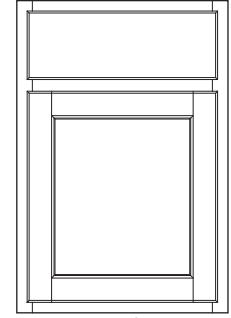

Kenosha
(page 13)

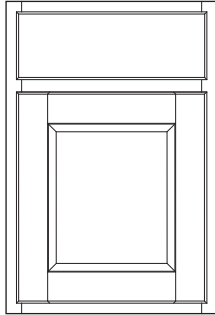

Lautner
(page 13)

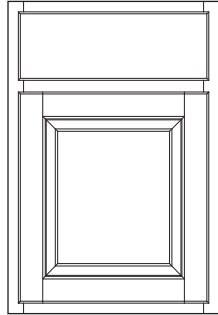

Wexford
(page 17)

DOOR STYLE SPECIFICATIONS

Paint

- When Paint or Paint with Glaze finish is specified, select doors and/or drawer front center panels may be constructed of Medium Density Fiberboard (MDF). MDF provides a smooth finish when painted, and is resistant to warping, expansion, and contraction. Facings may consist of other hardwood components.

All Door Styles

- All doors and drawer fronts are 3/4" thick unless otherwise noted.

Door and Drawer Front Side Profiles

- Veneer and MDF components are shown with gray shading on side profiles. Solid-wood components do not have shading.

Wood Grain

- See reference images for wood grain direction on all door styles.

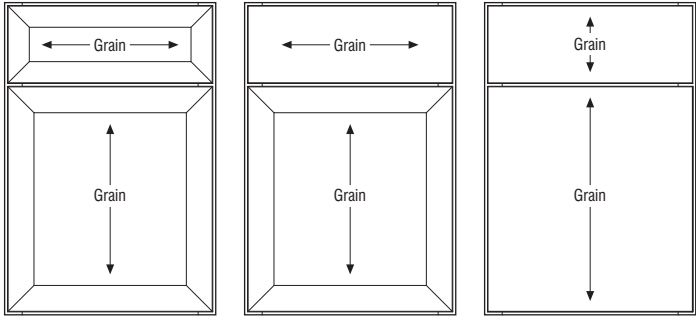

Chalet

Wood Grain – Wall Top Hinge (WTH) Cabinets, 30"-36" Wide

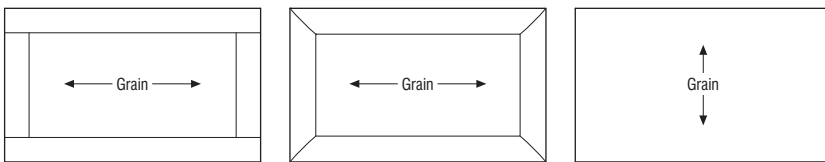

Non-miter Door Styles

Miter Door Styles

Chalet

DOOR STYLES

Arbor	Hickory	Maple	Oak	Painted Hardwood	Rustic Hickory	Laminate	NEW PureStyle™
	Price Point 1	2	1	2	2	—	2

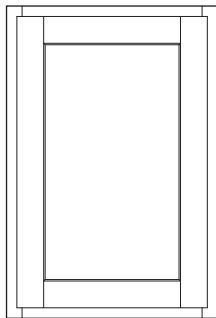

Wall (Wood Species)

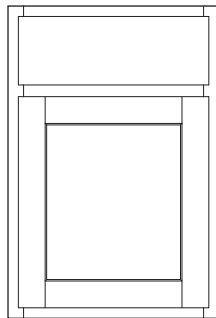

Base (Wood Species)

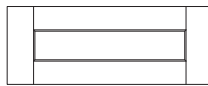

Optional 5-piece Drawer Front (DFF5PC) (Wood Species)

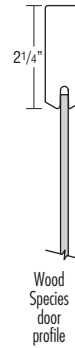
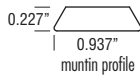

Wood Species door profile



Wood Species drawer front profile

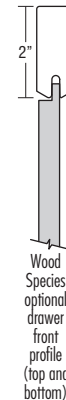

Wood Species optional drawer front profile (top and bottom)

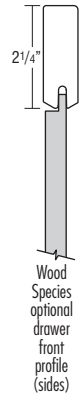

Wood Species optional drawer front profile (sides)

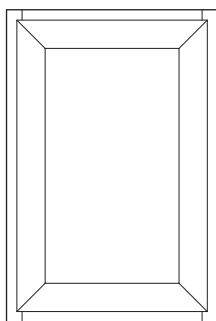

Wall (PureStyle™)

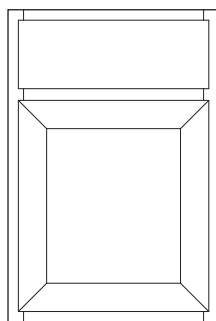

Base (PureStyle™)

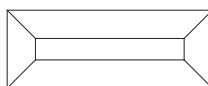

Optional 5-piece Drawer Front (DFF5PC) (PureStyle™)

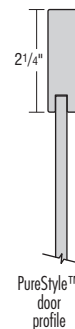
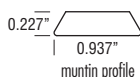

PureStyle™ door profile



PureStyle™ drawer front profile



PureStyle™ optional drawer front profile

- Traditional Overlay
- 3/16" Veneer Recessed Center Panel in 3/4" Hardwood Frame
- Mortise and Tenon Joints (Wood Species)
- 45° Mitered Joints (PureStyle™)
- 3/4" Solid Hardwood Slab Drawer Front

- When Rustic Hickory is specified, the center panel will have rustic characteristics with the exception of open knots or openings that would expose the panel core.
- See page 26 for 5-piece drawer front dimensions when specifying decorative hardware.
- A heat shield is required to separate PureStyle™ doors, drawer fronts, overlay fillers, and all laminate products from heat producing units to be in compliance with cabinet warranty.

Bexley	Hickory	Maple	Oak	Painted Hardwood	Rustic Hickory	Laminate	PureStyle™
	Price Point 6	7	—	7	—	—	—

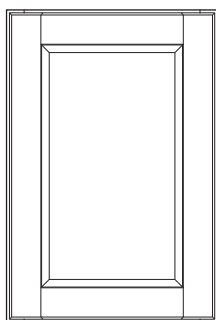

Wall

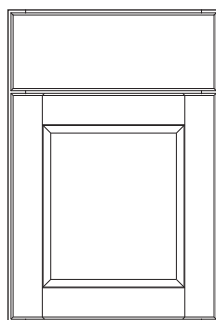

Base

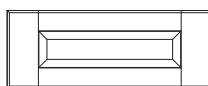

Optional 5-piece Drawer Front (DFF5PC)

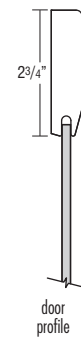
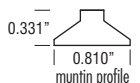

door profile



drawer front profile

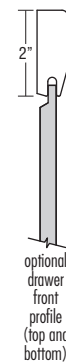

optional drawer front profile (top and bottom)

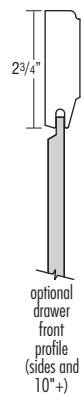

optional drawer front profile (sides and 10"+)

- Full/Modified Full Overlay
- 3/16" Veneer Recessed Center Panel in 3/4" Hardwood Frame

- Mortise and Tenon Joints
- 3/4" Solid Hardwood Slab Drawer Front
- See page 26 for 5-piece drawer front dimensions when specifying decorative hardware.

DOOR STYLES

Bishop

	Hickory	Maple	Oak	Painted Hardwood	Rustic Hickory	Laminate	PureStyle™
Price Point	—	6	4	6	—	—	—

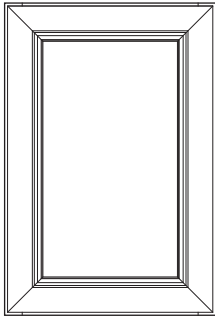

Wall

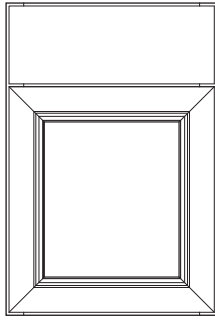

Base

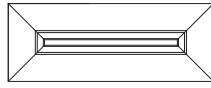

Optional 5-piece Drawer Front (DFF5PC)

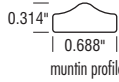

muntin profile

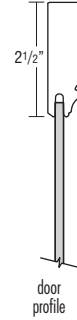

door profile



drawer front profile

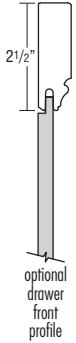

optional drawer front profile

- Full/Modified Full Overlay
- 3/16" Veneer Recessed Center Panel in 3/4" Hardwood Frame

- 45° Mitered Joints
- 3/4" Solid Hardwood Profiled Slab Drawer Front
- See page 26 for 5-piece drawer front dimensions when specifying decorative hardware.

Chalet

	Hickory	Maple	Oak	Painted Hardwood	Rustic Hickory	NEW Laminate	PureStyle™
Price Point	—	6	—	6	—	6	—

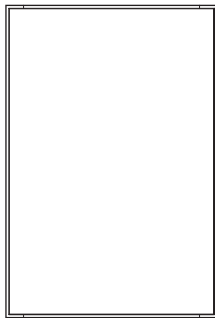

Wall

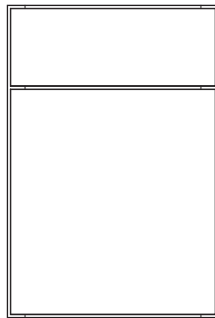

Base



door profile



drawer front profile

- Full/Modified Full Overlay
- 3/4" Slab Door and Drawer Front

- When Chalet is selected in Painted Hardwood, the doors and drawer fronts will be constructed of medium density fiberboard (MDF) or high density fiberboard (HDF).
- A heat shield is required to separate laminate doors, drawer fronts, overlay fillers, and all laminate products from heat producing units to be in compliance with cabinet warranty.

DOOR STYLES

Darwyn	Hickory	Maple	Oak	Painted Hardwood	Rustic Hickory	Laminate	NEW PureStyle™
	Price Point 6	7	6	7	7	—	7

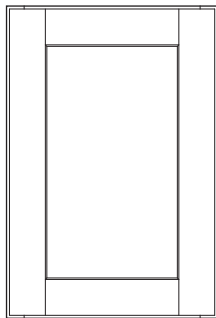

Wall (Wood Species)

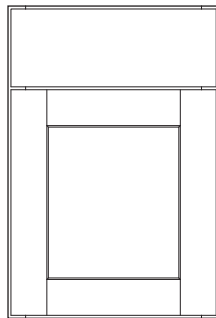

Base (Wood Species)

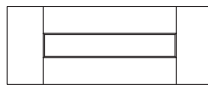

Optional 5-piece Drawer Front (DFF5PC) (Wood Species)

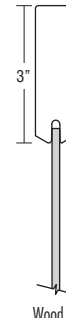
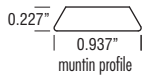

Wood Species door profile



Wood Species drawer front profile

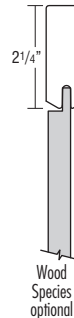

Wood Species optional drawer front profile (top and bottom)

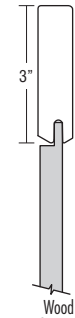

Wood Species optional drawer front profile (sides and 10"+)

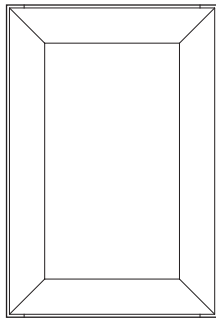

Wall (PureStyle™)

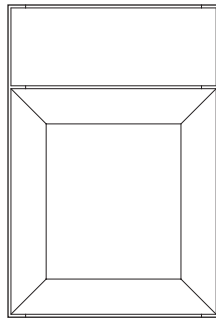

Base (PureStyle™)

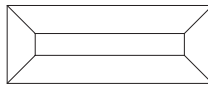

Optional 5-piece Drawer Front (DFF5PC) (PureStyle™)

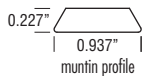

PureStyle™ door profile



PureStyle™ drawer front profile

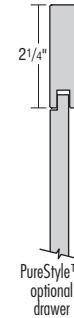

PureStyle™ optional drawer front profile

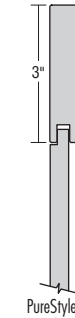

PureStyle™ optional drawer front profile 10"+

- Full/Modified Full Overlay
- 3/16" Veneer Recessed Center Panel in 3/4" Hardwood Frame
- Mortise and Tenon Joints (Wood Species)
- 45° Mitered Joints (PureStyle™)

- 3/4" Solid Hardwood Slab Drawer Front
- See page 26 for 5-piece drawer front dimensions when specifying decorative hardware.
- A heat shield is required to separate PureStyle™ doors, drawer fronts, overlay fillers, and all laminate products from heat producing units to be in compliance with cabinet warranty.

Dover	Hickory	Maple	Oak	Painted Hardwood	Rustic Hickory	Laminate	PureStyle™
	Price Point 7	8	7	8	8	—	—

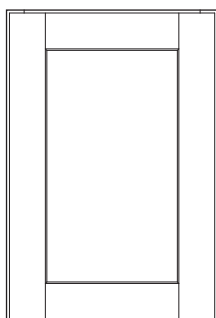

Wall

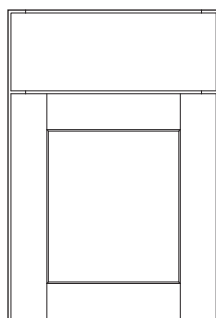

Base

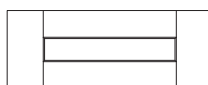

Optional No Charge 5-piece Drawer Front (DFF5PC)

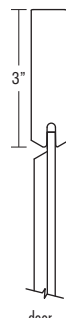
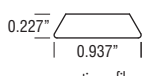

door profile



drawer front profile

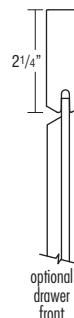

optional drawer front profile (top and bottom)



optional drawer front profile (sides and 10"+)

- Full/Modified Full Overlay
- 1/2" Solid Hardwood Reverse Raised Center Panel in 3/4" Hardwood Frame

- Mortise and Tenon Joints
- 3/4" Solid Hardwood Slab Drawer Front
- See page 26 for 5-piece drawer front dimensions when specifying decorative hardware.

DOOR STYLES

12

DOOR STYLES

Fyfer	Hickory	Maple	Oak	Painted Hardwood	Rustic Hickory	Laminate	PureStyle™
	Price Point	3	6	3	6	—	—

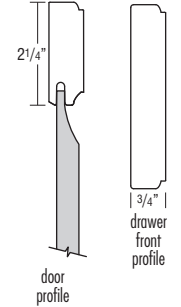
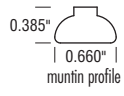
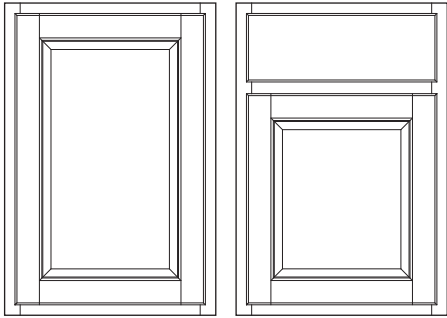

Wall

Base

- Traditional Overlay
- 7/16" Veneer Raised Center Panel in 3/4" Hardwood Frame
- Mortise and Tenon Joints
- 3/4" Solid Hardwood Profiled Slab Drawer Front

Highland	Hickory	Maple	Oak	Painted Hardwood	Rustic Hickory	Laminate	PureStyle™
	Price Point	—	8	—	8	—	—

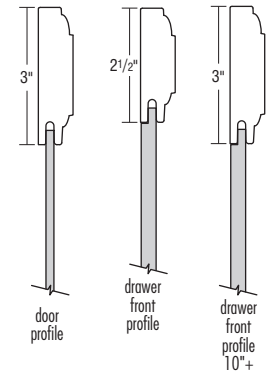
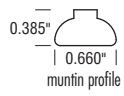
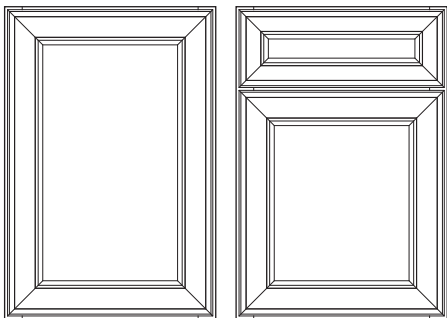

Wall

Base

- Full/Modified Full Overlay
- 3/16" Veneer Recessed Center Panel in 3/4" Hardwood Frame
- 45° Mitered Joints
- 5-piece Drawer Front
- See page 26 for 5-piece drawer front dimensions when specifying decorative hardware.

Joplin	Hickory	Maple	Oak	Painted Hardwood	Rustic Hickory	Laminate	PureStyle™
	Price Point	—	3	2	3	—	—

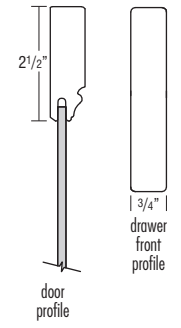
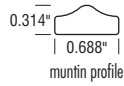
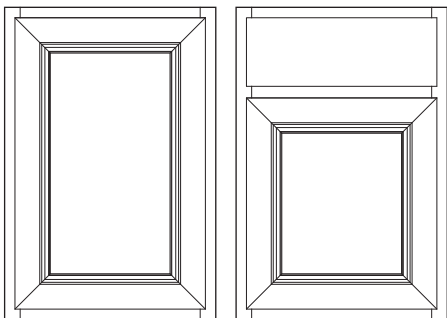

Wall

Base

- Traditional Overlay
- 3/16" Veneer Recessed Center Panel in 3/4" Hardwood Frame
- 45° Mitered Joints
- 3/4" Solid Hardwood Profiled Slab Drawer Front

DOOR STYLES

Kendrick	Hickory	Maple	Oak	Painted Hardwood	Rustic Hickory	Laminate	PureStyle™
	Price Point	3	6	3	6	—	—

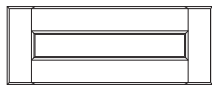
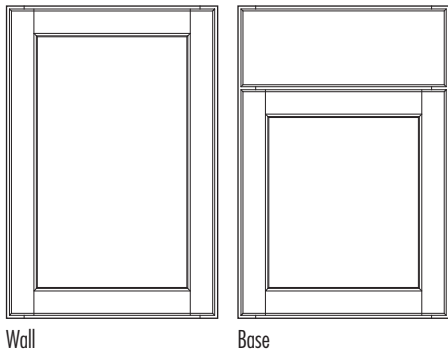

Optional 5-piece Drawer Front (DFF5PC)

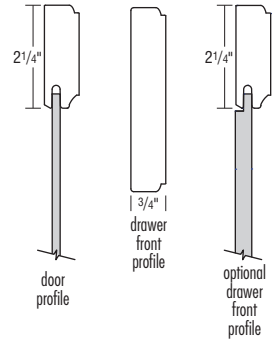
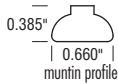

- Full/Modified Full Overlay
- 3/16" Veneer Recessed Center Panel in 3/4" Hardwood Frame

- Mortise and Tenon Joints
- 3/4" Solid Hardwood Profiled Slab Drawer Front
- See page 26 for 5-piece drawer front dimensions when specifying decorative hardware.

Kenosha	Hickory	Maple	Oak	Painted Hardwood	Rustic Hickory	Laminate	PureStyle™
	Price Point	1	2	1	2	—	—

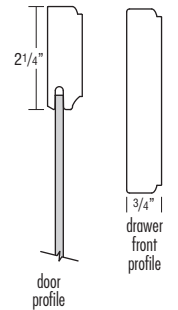
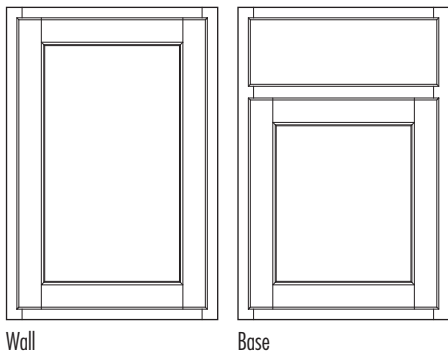

- Traditional Overlay
- 3/16" Veneer Recessed Center Panel in 3/4" Hardwood Frame

- 45° Mortise and Tenon Joints
- 3/4" Solid Hardwood Profiled Slab Drawer Front

Lautner	Hickory	Maple	Oak	Painted Hardwood	Rustic Hickory	Laminate	PureStyle™
	Price Point	2	3	—	3	—	—

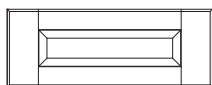
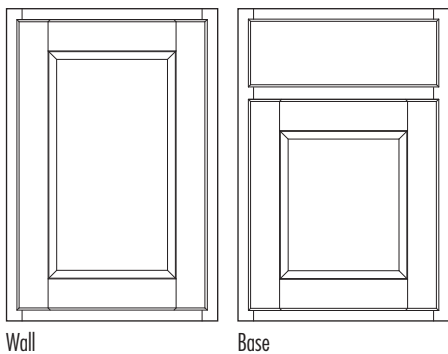

Optional 5-piece Drawer Front (DFF5PC)

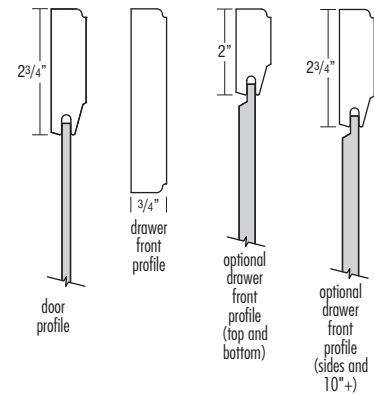
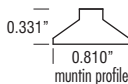

- Traditional Overlay
- 3/16" Veneer Recessed Center Panel in 3/4" Hardwood Frame

- Mortise and Tenon Joints
- 3/4" Solid Hardwood Slab Drawer Front
- See page 26 for 5-piece drawer front dimensions when specifying decorative hardware.

DOOR STYLES

Piper

	Hickory	Maple	Oak	Painted Hardwood	Rustic Hickory	Laminate	PureStyle™
Price Point	6	7	6	7	—	—	—

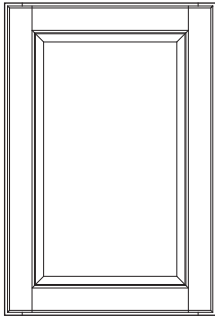

Wall

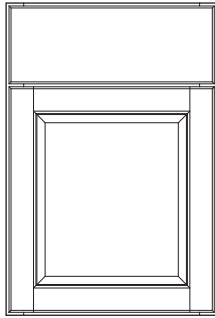

Base

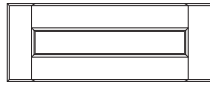

Optional 5-piece Drawer Front (DFF5PC)

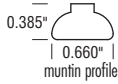

0.385" | 0.660" | muntin profile



2 1/4" | door profile



3/4" | drawer front profile

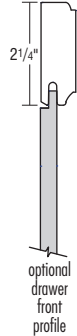

2 1/4" | optional drawer front profile

- Full/Modified Full Overlay
- 7/16" Veneer Raised Center Panel in 3/4" Hardwood Frame

- Mortise and Tenon Joints
- 3/4" Solid Hardwood Profiled Slab Drawer Front
- See page 26 for 5-piece drawer front dimensions when specifying decorative hardware.

Rosedale

	Hickory	Maple	Oak	Painted Hardwood	Rustic Hickory	Laminate	PureStyle™
Price Point	—	7	—	7	—	—	—

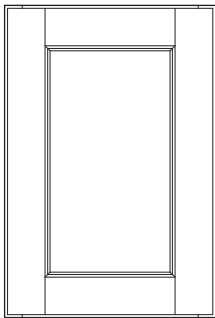

Wall

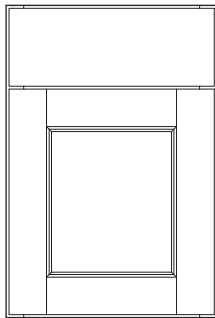

Base

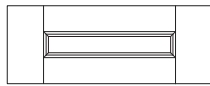

Optional 5-piece Drawer Front (DFF5PC)

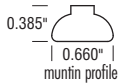

0.385" | 0.660" | muntin profile

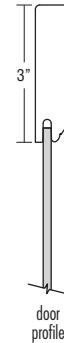

3" | door profile



3/4" | drawer front profile

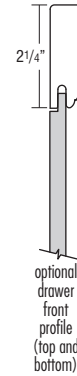

2 1/4" | optional drawer front profile (top and bottom)

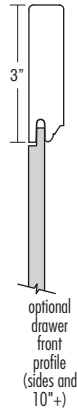

3" | optional drawer front profile (sides and 10"+)

- Full/Modified Full Overlay
- 3/16" Veneer Recessed Center Panel in 3/4" Hardwood Frame

- Mortise and Tenon Joints
- 3/4" Solid Hardwood Slab Drawer Front
- See page 26 for 5-piece drawer front dimensions when specifying decorative hardware.

DOOR STYLES

Sedona

	Hickory	Maple	Oak	Painted Hardwood	Rustic Hickory	Laminate	NEW PureStyle™
Price Point	6	7	6	7	7	—	7

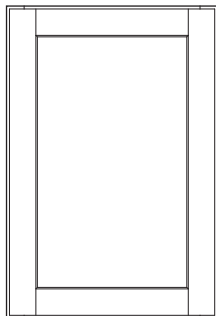

Wall (Wood Species)

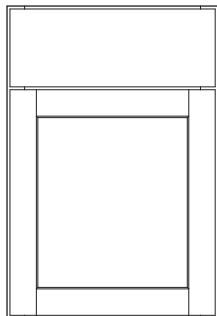

Base (Wood Species)

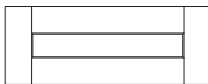

Optional No Charge 5-piece
Drawer Front (DF5PC)
(Wood Species)

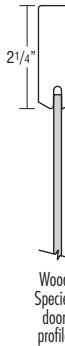
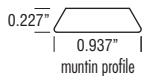

Wood Species
door profile



3/4" |
Wood Species
drawer
front
profile

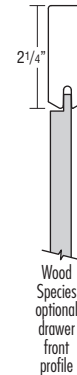

2 1/4"
Wood Species
optional
drawer
front
profile

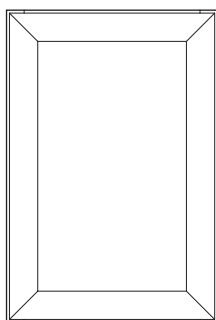

Wall (PureStyle™)

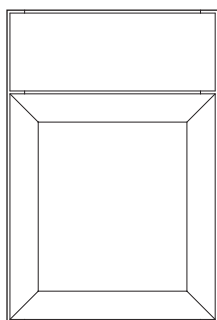

Base (PureStyle™)

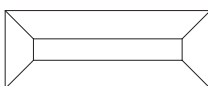

Optional No Charge 5-piece
Drawer Front (DF5PC)
(PureStyle™)

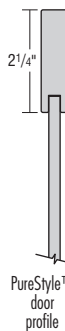
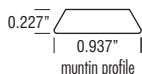

2 1/4"
PureStyle™
door
profile



3/4" |
PureStyle™
drawer
front
profile

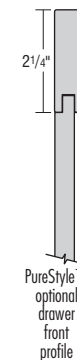

2 1/4"
PureStyle™
optional
drawer
front
profile

- Full/Modified Full Overlay
- 3/16" Veneer Recessed Center Panel in 3/4" Hardwood Frame
- Mortise and Tenon Joints (Wood Species)
- 45° Mitered Joints (PureStyle™)
- 3/4" Solid Hardwood Slab Drawer Front

- When Rustic Hickory is specified, the center panel will have rustic characteristics with the exception of open knots or openings that would expose the panel core.
- See page 26 for 5-piece drawer front dimensions when specifying decorative hardware.
- A heat shield is required to separate PureStyle™ doors, drawer fronts, overlay fillers, and all laminate products from heat producing units to be in compliance with cabinet warranty.

DOOR STYLES

Waldron

	Hickory	Maple	Oak	Painted Hardwood	Rustic Hickory	Laminate	 PureStyle™
Price Point	6	7	6	7	—	—	7

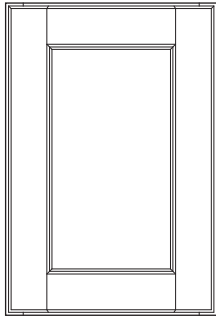

Wall (Wood Species)

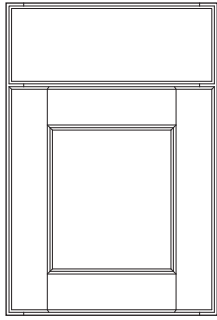

Base (Wood Species)

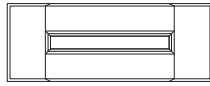

Optional 5-piece Drawer Front (DFF5PC) (Wood Species)

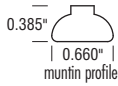

0.385" | 0.660" | muntin profile

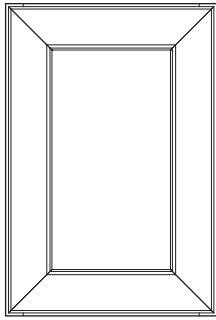

Wall (PureStyle™)

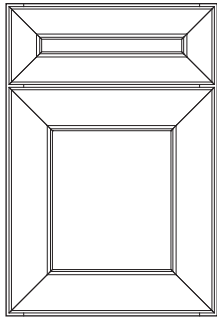

Base (PureStyle™)

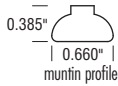

0.385" | 0.660" | muntin profile

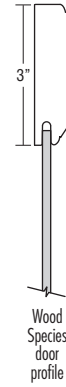

Wood Species door profile



3/4" | Wood Species drawer front profile

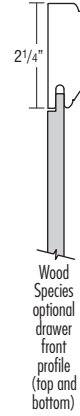

Wood Species optional drawer front profile (top and bottom)

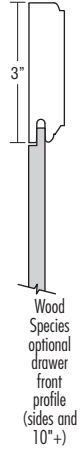

Wood Species optional drawer front profile (sides and 10"+)

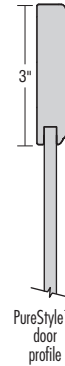

PureStyle™ door profile

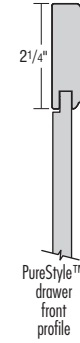

PureStyle™ drawer front profile

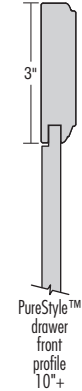

PureStyle™ drawer front profile 10"+

16

DOOR STYLES

- Full/Modified Full Overlay
- 3/16" Veneer Recessed Center Panel in 3/4" Hardwood Frame
- Mortise and Tenon Joints (Wood Species)
- 45° Mitered Joints (PureStyle™)

- 3/4" Solid Hardwood Profiled Slab Drawer Front (Wood Species)
- See page 26 for 5-piece drawer front dimensions when specifying decorative hardware.
- A heat shield is required to separate PureStyle™ doors, drawer fronts, overlay fillers, and all laminate products from heat producing units to be in compliance with cabinet warranty.

DOOR STYLES

Welzin

	Hickory	Maple	Oak	Painted Hardwood	Rustic Hickory	Laminate	PureStyle™
Price Point	7	8	7	8	—	—	—

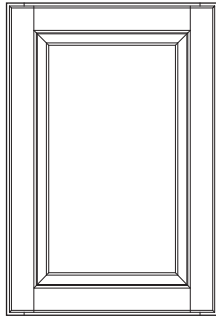

Wall

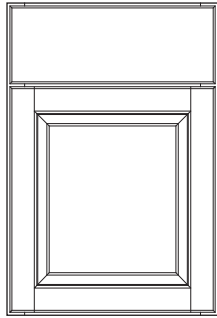

Base

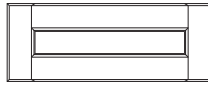

Optional 5-piece Drawer Front (DFF5PC)

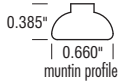

0.385" muntin profile



2 1/4" door profile



3/4" drawer front profile

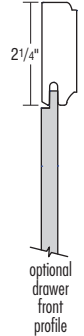

2 1/4" optional drawer front profile

- Full/Modified Full Overlay
- 9/16" Solid Raised Center Panel in 3/4" Hardwood Frame
- Mortise and Tenon Joints

- 3/4" Solid Hardwood Profiled Slab Drawer Front
- See page 26 for 5-piece drawer front dimensions when specifying decorative hardware.

Wexford

	Hickory	Maple	Oak	Painted Hardwood	Rustic Hickory	Laminate	PureStyle™
Price Point	5	7	5	7	7	—	—

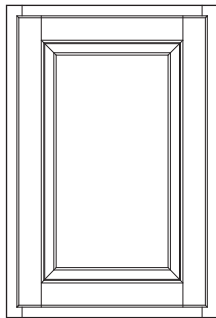

Wall

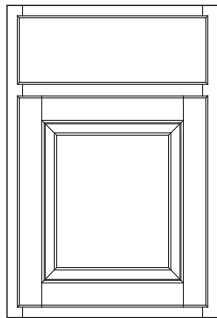

Base

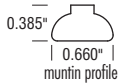

0.385" muntin profile



2 1/4" door profile



3/4" drawer front profile

- Traditional Overlay
- 9/16" Solid Raised Center Panel in 3/4" Hardwood Frame

- Mortise and Tenon Joints
- 3/4" Solid Hardwood Profiled Slab Drawer Front

FINISH PROCESS AND CHARACTERISTICS

We put our finishes to the test. Homecrest's multi-step finish is both beautiful and durable. To test the UV/oven-cured catalyzed varnish finish, twenty-six different household chemicals and agents were used. Three cc of each chemical/agent were applied to a test door and covered for a 24-hour period. Then the agent was washed off to determine the effect it had on the finish. The results are impressive. Homecrest passed each and every test.

HOMECREST CABINETRY FINISHING PROCESS

- 1. Wood Selection** – The selection of the finest woods is the essential first step of Homecrest's finishing process.
- 2. Sanded to Perfection** – Our sanding utilizes an ultra fine grit paper, both with and against the wood grain. This process is completed on a vacuum table, allowing for a wood surface that is free of all dust particles.
- 3. Stain Application** – An environmentally safe stain is evenly applied to all surfaces. This deep penetrating stain is applied for even coverage on all profiles. On multi-step stains and glaze finishes, some non-facing surfaces (such as backs of doors, backs of panels, and matching veneer interiors) may not receive all steps noted. The resulting finish will be complementary and similar in color and have the same catalyzed top coat and cure, but may not result in the same color depth as facing surfaces.
- 4. Removal of Excess Stain** – The wood is brushed to remove excess stain, emphasizing the cabinet's natural wood grain (where applicable).
- 5. Sanding Sealer** – A coat of tough, non-yellowing, sealer is applied to protect the grain from moisture.
- 6. Drying Process** – For added durability, the sealed wood is cured to lock in the beauty of wood.
- 7. Hand-Sanded** – To achieve an ultra-smooth finish, the wood is hand-sanded one last time.
- 8. Dust Removal** – The resulting dust is removed with both manual and automatic processes, which remove loose particles from the surface of the wood.
- 9. Top Coat** – A second application of a premium quality top coat is applied to protect the wood from yellowing and other environmental elements.
- 10. UV/Oven Cure** – The top coat is UV/oven cured to guarantee the strongest, most beautiful finish.
- 11. Final Inspection** – This last, thorough, inspection ensures lasting quality and beauty. Our gift to you is that every cabinet is crafted with care.

CHARACTERISTICS OF GLAZING/PAINT

Characteristics of Glazing

A professional layer of glaze can add another layer of beauty to your cabinets. Homecrest's hand-detailed glaze application adds depth and dimension to cabinet appearance by highlighting the profile of your door style choice.



What to expect from glazed cabinetry...

- Hand-detailed glazing will leave a consistent, "penned" appearance around the profile.
- You should expect the result to yield a subtle to dramatic look based on the complexity of the cabinet design.
- Printed materials and online, electronic presentations can only do so much. It is important to both see and touch actual finished samples to ensure your satisfaction.

Characteristics of Painted Finishes







Paint may develop hairline cracks in the finish, most notable around the joints. This is a result of natural expansion and contraction of the genuine hardwoods used in the manufacturing of this product. Hairline cracks are not considered a defect in the cabinetry or finish and will not be considered a reason for product replacement. A signed Paint Finish Awareness Agreement is required for all Paint orders—found on page 180.

FINISH AVAILABILITY

Maple		Arbor	Bexley	Bishop	Chalet	Darwyn	Dover	Fyfer	Highland	Joplin	Kendrick	Kenosha	Lautner	Piper	Rosedale	Sedona	Waldron	Welzin	Wexford	
		Standard Finishes	Anchor	Buckboard	Derby	Fallow	Karoo	Mane	Natural	Porter	Terrain	Trellis	Wren	Unfinished** 						
	Anchor	✓	✓	✓	✓	✓	✓	✓	✓	✓	✓	✓	✓	✓	✓	✓	✓	✓	✓	✓
	Buckboard	✓	✓	✓	✓	✓	✓	✓	✓	✓	✓	✓	✓	✓	✓	✓	✓	✓	✓	✓
	Derby	✓	✓	✓	✓	✓	✓	✓	✓	✓	✓	✓	✓	✓	✓	✓	✓	✓	✓	✓
	Fallow	✓	✓	✓	✓	✓	✓	✓	✓	✓	✓	✓	✓	✓	✓	✓	✓	✓	✓	✓
	Karoo	✓	✓	✓	✓	✓	✓	✓	✓	✓	✓	✓	✓	✓	✓	✓	✓	✓	✓	✓
	Mane	✓	✓	✓	✓	✓	✓	✓	✓	✓	✓	✓	✓	✓	✓	✓	✓	✓	✓	✓
	Natural	✓	✓	✓	✓	✓	✓	✓	✓	✓	✓	✓	✓	✓	✓	✓	✓	✓	✓	✓
	Porter	✓	✓	✓	✓	✓	✓	✓	✓	✓	✓	✓	✓	✓	✓	✓	✓	✓	✓	✓
	Terrain	✓	✓	✓	✓	✓	✓	✓	✓	✓	✓	✓	✓	✓	✓	✓	✓	✓	✓	✓
	Trellis	✓	✓	✓	✓	✓	✓	✓	✓	✓	✓	✓	✓	✓	✓	✓	✓	✓	✓	✓
	Wren	✓	✓	✓	✓	✓	✓	✓	✓	✓	✓	✓	✓	✓	✓	✓	✓	✓	✓	✓
	Unfinished** 	✓	✓	✓	✓	✓	✓	✓	✓	✓	✓	✓	✓	✓	✓	✓	✓	✓	✓	✓
Wood Tone Glazes*	Brownstone	12%	12%	12%		12%	12%	12%	12%	12%	12%	12%	12%	12%	12%	12%	12%	12%	12%	12%
	Ebony	12%	12%	12%		12%	12%	12%	12%	12%	12%	12%	12%	12%	12%	12%	12%	12%	12%	12%

*Wood Tone Glazes available on all Standard Finishes.

**When ordered in Unfinished, APU or PEU must be ordered. Discount of 5% applied to all applicable products. When cabinets are finished by an outside source, finish is not covered under warranty. Interiors of cabinets will be natural Maple laminate. For finishable interiors, MI must be specified.

Painted Hardwood		Arbor	Bexley	Bishop	Chalet	Darwyn	Dover	Fyfer	Highland	Joplin	Kendrick	Kenosha	Lautner	Piper	Rosedale	Sedona	Waldron	Welzin	Wexford	
		Paints 	Alpine	French Vanilla**	Galaxy	Haven 	Iceberg	Mystic 	Onyx	Peacock	Poolhouse	Willow								
	Alpine	11%	11%	11%	11%	11%	11%	11%	11%	11%	11%	11%	11%	11%	11%	11%	11%	11%	11%	11%
	French Vanilla**	11%	11%	11%	11%	11%	11%	11%	11%	11%	11%	11%	11%	11%	11%	11%	11%	11%	11%	11%
	Galaxy	11%	11%	11%	11%	11%	11%	11%	11%	11%	11%	11%	11%	11%	11%	11%	11%	11%	11%	11%
	Haven 	11%	11%	11%	11%	11%	11%	11%	11%	11%	11%	11%	11%	11%	11%	11%	11%	11%	11%	11%
	Iceberg	11%	11%	11%	11%	11%	11%	11%	11%	11%	11%	11%	11%	11%	11%	11%	11%	11%	11%	11%
	Mystic 	11%	11%	11%	11%	11%	11%	11%	11%	11%	11%	11%	11%	11%	11%	11%	11%	11%	11%	11%
	Onyx	11%	11%	11%	11%	11%	11%	11%	11%	11%	11%	11%	11%	11%	11%	11%	11%	11%	11%	11%
	Peacock	11%	11%	11%	11%	11%	11%	11%	11%	11%	11%	11%	11%	11%	11%	11%	11%	11%	11%	11%
	Poolhouse	11%	11%	11%	11%	11%	11%	11%	11%	11%	11%	11%	11%	11%	11%	11%	11%	11%	11%	11%
	Willow	11%	11%	11%	11%	11%	11%	11%	11%	11%	11%	11%	11%	11%	11%	11%	11%	11%	11%	11%
Paints with Glazes* 	Brownstone	16%	16%	16%		16%	16%	16%	16%	16%	16%	16%	16%	16%	16%	16%	16%	16%	16%	16%
	Ebony	16%	16%	16%		16%	16%	16%	16%	16%	16%	16%	16%	16%	16%	16%	16%	16%	16%	16%

*Glazes available on all Paints.

**French Vanilla will be available through April 2024.

Painted Hardwood finishes combine hardwoods and engineered materials including solid-wood, engineered materials — such as medium density fiberboard (MDF) and high density fiberboard (HDF) — and similar composite materials providing a smoother surface for painting and superior stability, consistency, and durability.

 Signed finish agreement required, see page 180.

FINISH AVAILABILITY

Hickory		Arbor	Bexley	Darwyn	Dover	Fyfer	Kendrick	Kenosha	Lautner	Piper	Sedona	Waldron	Welzin	Wexford
Standard Finishes	Anchor	✓	✓	✓	✓	✓	✓	✓	✓	✓	✓	✓	✓	✓
	Buckboard	✓	✓	✓	✓	✓	✓	✓	✓	✓	✓	✓	✓	✓
	Derby	✓	✓	✓	✓	✓	✓	✓	✓	✓	✓	✓	✓	✓
	Fallow	✓	✓	✓	✓	✓	✓	✓	✓	✓	✓	✓	✓	✓
	Karoo	✓	✓	✓	✓	✓	✓	✓	✓	✓	✓	✓	✓	✓
	Natural	✓	✓	✓	✓	✓	✓	✓	✓	✓	✓	✓	✓	✓
	Porter	✓	✓	✓	✓	✓	✓	✓	✓	✓	✓	✓	✓	✓
	Terrain	✓	✓	✓	✓	✓	✓	✓	✓	✓	✓	✓	✓	✓
	Trellis	✓	✓	✓	✓	✓	✓	✓	✓	✓	✓	✓	✓	✓
	Wren	✓	✓	✓	✓	✓	✓	✓	✓	✓	✓	✓	✓	✓
	Unfinished** 	✓	✓	✓	✓	✓	✓	✓	✓	✓	✓	✓	✓	✓
Wood Tone Glazes*	Brownstone	12%	12%	12%	12%	12%	12%	12%	12%	12%	12%	12%	12%	12%
	Ebony	12%	12%	12%	12%	12%	12%	12%	12%	12%	12%	12%	12%	12%

*Wood Tone Glazes available on all Standard Finishes.

**When ordered in Unfinished, APU or PEU must be ordered. Discount of 5% applied to all applicable products. When cabinets are finished by an outside source, finish is not covered under warranty. Interiors of cabinets will be natural Maple laminate. For finishable interiors, MI must be specified.

Rustic Hickory		Arbor	Darwyn	Dover	Sedona	Wexford
Standard Finishes	Anchor	✓	✓	✓	✓	✓
	Buckboard	✓	✓	✓	✓	✓
	Derby	✓	✓	✓	✓	✓
	Fallow	✓	✓	✓	✓	✓
	Karoo	✓	✓	✓	✓	✓
	Natural	✓	✓	✓	✓	✓
	Porter	✓	✓	✓	✓	✓
	Terrain	✓	✓	✓	✓	✓
	Trellis	✓	✓	✓	✓	✓
	Wren	✓	✓	✓	✓	✓
	Unfinished** 	✓	✓	✓	✓	✓
Wood Tone Glazes*	Brownstone	12%	12%	12%	12%	12%
	Ebony	12%	12%	12%	12%	12%

*Wood Tone Glazes available on all Standard Finishes.

**When ordered in Unfinished, APU or PEU must be ordered. Discount of 5% applied to all applicable products. When cabinets are finished by an outside source, finish is not covered under warranty. Interiors of cabinets will be natural Maple laminate. For finishable interiors, MI must be specified.

FINISH AVAILABILITY

Oak		Arbor	Bishop	Darwyn	Dover	Fyfer	Joplin	Kendrick	Kenosha	Piper	Sedona	Waldron	Welzin	Wexford
Standard Finishes	Anchor	✓	✓	✓	✓	✓	✓	✓	✓	✓	✓	✓	✓	✓
	Buckboard	✓	✓	✓	✓	✓	✓	✓	✓	✓	✓	✓	✓	✓
	Derby	✓	✓	✓	✓	✓	✓	✓	✓	✓	✓	✓	✓	✓
	Fallow	✓	✓	✓	✓	✓	✓	✓	✓	✓	✓	✓	✓	✓
	Karoo	✓	✓	✓	✓	✓	✓	✓	✓	✓	✓	✓	✓	✓
	Mane	✓	✓	✓	✓	✓	✓	✓	✓	✓	✓	✓	✓	✓
	Natural	✓	✓	✓	✓	✓	✓	✓	✓	✓	✓	✓	✓	✓
	Porter	✓	✓	✓	✓	✓	✓	✓	✓	✓	✓	✓	✓	✓
	Terrain	✓	✓	✓	✓	✓	✓	✓	✓	✓	✓	✓	✓	✓
	Trellis	✓	✓	✓	✓	✓	✓	✓	✓	✓	✓	✓	✓	✓
	Wren	✓	✓	✓	✓	✓	✓	✓	✓	✓	✓	✓	✓	✓
	Unfinished** 	✓	✓	✓	✓	✓	✓	✓	✓	✓	✓	✓	✓	✓

**When ordered in Unfinished, APU or PEU must be ordered. Discount of 5% applied to all applicable products. When cabinets are finished by an outside source, finish is not covered under warranty. Interiors of cabinets will be natural Maple laminate. For finishable interiors, MI must be specified.

PureStyle™/Laminate 		Arbor	Chalet	Darwyn	Sedona	Waldron
Laminate Finishes	Alpine	✓	✓	✓	✓	✓
	Galaxy	✓	✓	✓	✓	✓
	Iceberg	✓	✓	✓	✓	✓
	Poolhouse	✓	✓	✓	✓	✓
	Willow	✓	✓	✓	✓	✓

CONSTRUCTION SPECIFICATIONS

	HOMECREST STANDARD	ALL-PLYWOOD CONSTRUCTION†
Doors & Drawer Fronts	See "Door Styles" pages 6-17 for door and drawer front configuration and construction details.	
Front Frames	3/4" thick solid hardwood stiles and rails.	
Sta-Beam™	The Sta-Beam method utilizes 3/8" furniture board dadoed into face frame, end panels and back panels.	The Sta-Beam method utilizes 3/8" plywood dadoed into face frame, end panels and back panels.
Cabinet Sides	1/2" furniture board with natural Maple laminate interiors and matching laminate exterior.	1/2" plywood with natural Maple laminate interior and veneer exterior.
Cabinet Tops & Bottoms (Wall & Tall)	3/8" furniture board with natural Maple laminate interior and exterior surfaces.	3/8" plywood with natural Maple laminate interior and exterior surfaces.
Cabinet Bottoms (Base & Vanity)	3/8" furniture board with natural Maple laminate interior surface.	3/8" plywood with natural Maple laminate interior surface.
Cabinet Backs	3/8" furniture board with natural Maple laminate interior. Base cabinets have 3mm system holes for easy drawer and roll tray installation.	3/8" plywood with natural Maple laminate interior. Base cabinets have 3mm system holes for easy drawer and roll tray installation.
Shelves	3/4" thick laminated furniture board shelves feature PVC edgebanding to protect exposed edges. Adjustable in both wall and base cabinets.	3/4" thick laminated plywood shelves feature PVC edgebanding to protect exposed edges. Adjustable in both wall and base cabinets.
Hinges	Hinges: Fully concealed, integrated SofTouch cup hinge (INTGH); 6-way adjustable and self-closing. Hinge features deactivation option. NSCH Mod: Fully concealed cup hinge; 6-way adjustable and self-closing.	
Drawer Box Construction and Drawer Guide	<p>WDRW - Standard Wood Dovetail Drawer Box with SofTouch Guide: Four-sided clear coated solid hardwood drawer box with dovetailed construction and 5.2mm laminated plywood captured in drawer sides, front, and back. SofTouch features a self-closing, full extension mechanism, with a cushion close feature which prevents the drawer from slamming. Adjustable steel undermount full extension drawer guide system is completely hidden.</p> <p>FDRW - Furniture Board Drawer Box Option: 1/2" thick, four-sided construction with 3/8" thick bottom. Epoxy-coated steel drawer guides wrap around drawer bottom 1/2" for added strength.</p>	
Toekick	Toekick area is unfinished furniture board, inset between the cabinet end panels. Matching laminated or veneered toekick overlay is available in 8' lengths.	Toekick area is unlaminated plywood, inset between the cabinet end panels. Matching laminated or veneered toekick overlay is available in 8' lengths.

STANDARD CONSTRUCTION SPECIFICATIONS

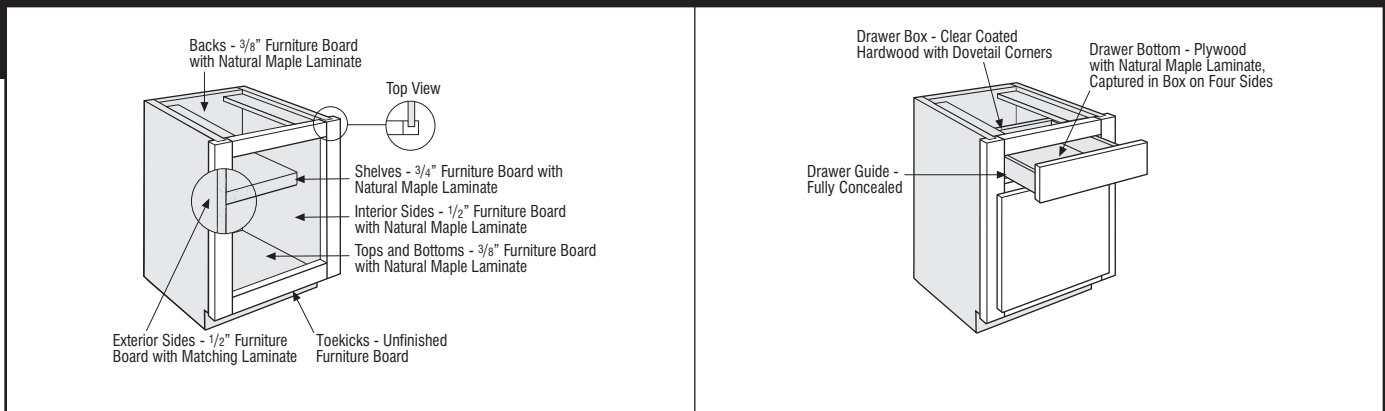

†All-plywood components meet ANSI/HPVA HP-1 standards and may contain MDF or particleboard.

COMPATIBLE MODIFICATIONS

		APU	PEU	WDRW/FDRW	RTPG	INTGH/NSCH	DFF5PC	AUTHL	AUTHR	AUTHB	FB	FPEB	ACS	CBO	CCO	CFNTO	CFP	CFRMO	CND	EXL	EXR	ID	P	RD	FULL	MFO	MI	FD	ADDTK	FTK	FTKAV	FTKFV	RECTKBK	RECTKL	RECTKR	RECTKALL	VTK	MD	CG						
Starting Modification	Construction Upgrades	APU	✓		✓	✓	✓	✓	✓	✓	✓	✓	✓	✓	✓	✓	✓	✓	✓	✓	✓	✓	✓	✓	✓	✓	✓	✓	✓	✓	✓	✓	✓	✓	✓	✓	✓	✓	✓	✓					
		PEU		✓		✓	✓					✓	✓	✓	✓	✓	✓	✓	✓	✓	✓	✓	✓	✓	✓	✓	✓	✓	✓	✓	✓	✓	✓	✓	✓	✓	✓	✓	✓	✓	✓	✓			
	Drawer, Roll Tray, Hinge, and Drawer Front Options	WDRW/FDRW	✓	✓	✓		✓	✓	✓	✓	✓	✓	✓	✓	✓	✓	✓	✓	✓	✓	✓	✓	✓	✓	✓	✓	✓	✓	✓	✓	✓	✓	✓	✓	✓	✓	✓	✓	✓	✓	✓	✓	✓		
		RTPG	✓	✓		✓	✓	✓	✓	✓	✓	✓	✓	✓	✓	✓	✓	✓	✓	✓	✓	✓	✓	✓	✓	✓	✓	✓	✓	✓	✓	✓	✓	✓	✓	✓	✓	✓	✓	✓	✓	✓	✓		
		INTGH/NSCH	✓	✓	✓	✓	✓	✓	✓	✓	✓	✓	✓	✓	✓	✓	✓	✓	✓	✓	✓	✓	✓	✓	✓	✓	✓	✓	✓	✓	✓	✓	✓	✓	✓	✓	✓	✓	✓	✓	✓	✓	✓		
		DFF5PC*	✓	✓	✓	✓	✓	✓	✓	✓	✓	✓	✓	✓	✓	✓	✓	✓	✓	✓	✓	✓	✓	✓	✓	✓	✓	✓	✓	✓	✓	✓	✓	✓	✓	✓	✓	✓	✓	✓	✓	✓	✓		
	End Panel Modifications	AUTHL	✓		✓	✓	✓	✓	✓	✓	✓	✓	✓	✓	✓	✓	✓	✓	✓	✓	✓	✓	✓	✓	✓	✓	✓	✓	✓	✓	✓	✓	✓	✓	✓	✓	✓	✓	✓	✓	✓	✓	✓		
		AUTHR	✓		✓	✓	✓	✓	✓	✓	✓	✓	✓	✓	✓	✓	✓	✓	✓	✓	✓	✓	✓	✓	✓	✓	✓	✓	✓	✓	✓	✓	✓	✓	✓	✓	✓	✓	✓	✓	✓	✓	✓		
		AUTHB	✓		✓	✓	✓	✓	✓	✓	✓	✓	✓	✓	✓	✓	✓	✓	✓	✓	✓	✓	✓	✓	✓	✓	✓	✓	✓	✓	✓	✓	✓	✓	✓	✓	✓	✓	✓	✓	✓	✓	✓		
		FB	✓	✓	✓	✓	✓	✓	✓	✓	✓	✓	✓	✓	✓	✓	✓	✓	✓	✓	✓	✓	✓	✓	✓	✓	✓	✓	✓	✓	✓	✓	✓	✓	✓	✓	✓	✓	✓	✓	✓	✓	✓		
		FPEB	✓		✓	✓	✓	✓	✓	✓	✓	✓	✓	✓	✓	✓	✓	✓	✓	✓	✓	✓	✓	✓	✓	✓	✓	✓	✓	✓	✓	✓	✓	✓	✓	✓	✓	✓	✓	✓	✓	✓	✓		
	Box Modifications	ACS	✓	✓	✓	✓	✓	✓	✓	✓	✓	✓	✓	✓	✓	✓	✓	✓	✓	✓	✓	✓	✓	✓	✓	✓	✓	✓	✓	✓	✓	✓	✓	✓	✓	✓	✓	✓	✓	✓	✓	✓	✓		
		CBO	✓	✓	✓	✓			✓	✓	✓	✓	✓	✓	✓	✓	✓	✓	✓	✓	✓	✓	✓	✓	✓	✓	✓	✓	✓	✓	✓	✓	✓	✓	✓	✓	✓	✓	✓	✓	✓	✓	✓	✓	
		CCO	✓	✓					✓	✓	✓	✓	✓	✓	✓	✓	✓	✓	✓	✓	✓	✓	✓	✓	✓	✓	✓	✓	✓	✓	✓	✓	✓	✓	✓	✓	✓	✓	✓	✓	✓	✓	✓	✓	✓
		CFNTO					✓	✓						✓			✓				✓	✓				✓	✓			✓	✓	✓								✓	✓	✓			
		CFP	✓	✓	✓	✓	✓	✓	✓	✓	✓	✓	✓					✓				✓	✓	✓	✓	✓	✓	✓	✓	✓	✓	✓	✓	✓	✓	✓	✓	✓	✓	✓	✓	✓	✓		
		CFRMO																		✓	✓									✓	✓	✓													
		CND	✓	✓	✓	✓		✓	✓	✓	✓	✓	✓	✓	✓	✓	✓	✓	✓	✓	✓	✓	✓	✓	✓	✓	✓	✓	✓	✓	✓	✓	✓	✓	✓	✓	✓	✓	✓	✓	✓	✓	✓	✓	
		EXL	✓	✓	✓	✓	✓	✓	✓	✓	✓	✓	✓	✓	✓	✓	✓	✓	✓	✓	✓	✓	✓	✓	✓	✓	✓	✓	✓	✓	✓	✓	✓	✓	✓	✓	✓	✓	✓	✓	✓	✓	✓	✓	
		EXR	✓	✓	✓	✓	✓	✓	✓	✓	✓	✓	✓	✓	✓	✓	✓	✓	✓	✓	✓	✓	✓	✓	✓	✓	✓	✓	✓	✓	✓	✓	✓	✓	✓	✓	✓	✓	✓	✓	✓	✓	✓	✓	
ID		✓	✓		✓	✓	✓	✓	✓	✓	✓	✓	✓	✓	✓	✓	✓	✓	✓	✓	✓	✓	✓	✓	✓	✓	✓	✓	✓	✓	✓	✓	✓	✓	✓	✓	✓	✓	✓	✓	✓	✓	✓	✓	
P		✓	✓	✓		✓	✓	✓	✓	✓	✓	✓	✓	✓	✓	✓	✓	✓	✓	✓	✓	✓	✓	✓	✓	✓	✓	✓	✓	✓	✓	✓	✓	✓	✓	✓	✓	✓	✓	✓	✓	✓	✓	✓	
RD		✓	✓	✓	✓	✓	✓	✓	✓	✓	✓	✓	✓	✓	✓	✓	✓	✓	✓	✓	✓	✓	✓	✓	✓	✓	✓	✓	✓	✓	✓	✓	✓	✓	✓	✓	✓	✓	✓	✓	✓	✓	✓	✓	
Overlay Modification	FULL	✓	✓	✓	✓	✓	✓	✓	✓	✓	✓	✓	✓	✓	✓	✓	✓	✓	✓	✓	✓	✓	✓	✓	✓	✓	✓	✓	✓	✓	✓	✓	✓	✓	✓	✓	✓	✓	✓	✓	✓	✓	✓		
	MFO	✓	✓	✓	✓	✓	✓	✓	✓	✓	✓	✓	✓	✓	✓	✓	✓	✓	✓	✓	✓	✓	✓	✓	✓	✓	✓	✓	✓	✓	✓	✓	✓	✓	✓	✓	✓	✓	✓	✓	✓	✓	✓	✓	
Interior Modifications	MI			✓	✓	✓	✓	✓	✓	✓	✓	✓	✓	✓	✓	✓	✓	✓	✓	✓	✓	✓	✓	✓	✓	✓	✓	✓	✓	✓	✓	✓	✓	✓	✓	✓	✓	✓	✓	✓	✓	✓	✓		
	FD	✓	✓	✓	✓	✓	✓	✓	✓	✓	✓	✓	✓	✓	✓	✓	✓	✓	✓	✓	✓	✓	✓	✓	✓	✓	✓	✓	✓	✓	✓	✓	✓	✓	✓	✓	✓	✓	✓	✓	✓	✓	✓		
Toekick Modifications	ADDTK	✓	✓	✓		✓	✓	✓	✓	✓	✓	✓	✓	✓	✓	✓	✓	✓	✓	✓	✓	✓	✓	✓	✓	✓	✓	✓	✓	✓	✓	✓	✓	✓	✓	✓	✓	✓	✓	✓	✓	✓	✓		
	FTK	✓	✓	✓	✓	✓	✓	✓	✓	✓	✓	✓	✓	✓	✓	✓	✓	✓	✓	✓	✓	✓	✓	✓	✓	✓	✓	✓	✓	✓	✓	✓	✓	✓	✓	✓	✓	✓	✓	✓	✓	✓	✓		
	FTKAV	✓	✓	✓	✓	✓	✓	✓	✓	✓	✓	✓	✓	✓	✓	✓	✓	✓	✓	✓	✓	✓	✓	✓	✓	✓	✓	✓	✓	✓	✓	✓	✓	✓	✓	✓	✓	✓	✓	✓	✓	✓	✓	✓	
	FTKFV	✓	✓	✓	✓	✓	✓	✓	✓	✓	✓	✓	✓	✓	✓	✓	✓	✓	✓	✓	✓	✓	✓	✓	✓	✓	✓	✓	✓	✓	✓	✓	✓	✓	✓	✓	✓	✓	✓	✓	✓	✓	✓	✓	
	RECTKBK	✓	✓	✓	✓	✓	✓	✓	✓	✓	✓	✓	✓	✓	✓	✓	✓	✓	✓	✓	✓	✓	✓	✓	✓	✓	✓	✓	✓	✓	✓	✓	✓	✓	✓	✓	✓	✓	✓	✓	✓	✓	✓		
	RECTKL	✓	✓	✓	✓	✓	✓	✓	✓	✓	✓	✓	✓	✓	✓	✓	✓	✓	✓	✓	✓	✓	✓	✓	✓	✓	✓	✓	✓	✓	✓	✓	✓	✓	✓	✓	✓	✓	✓	✓	✓	✓	✓		
	RECTKR	✓	✓	✓	✓	✓	✓	✓	✓	✓	✓	✓	✓	✓	✓	✓	✓	✓	✓	✓	✓	✓	✓	✓	✓	✓	✓	✓	✓	✓	✓	✓	✓	✓	✓	✓	✓	✓	✓	✓	✓	✓	✓		
	RECTKALL	✓	✓	✓	✓	✓	✓	✓	✓	✓	✓	✓	✓	✓	✓	✓	✓	✓	✓	✓	✓	✓	✓	✓	✓	✓	✓	✓	✓	✓	✓	✓	✓	✓	✓	✓	✓	✓	✓	✓	✓	✓	✓		
VTK	✓	✓	✓	✓	✓	✓	✓	✓	✓	✓	✓	✓	✓	✓	✓	✓	✓	✓	✓	✓	✓	✓	✓	✓	✓	✓	✓	✓	✓	✓	✓	✓	✓	✓	✓	✓	✓	✓	✓	✓	✓	✓			
Specialty Doors	MD					✓	✓	✓	✓	✓	✓	✓	✓	✓	✓	✓	✓	✓	✓	✓	✓	✓	✓	✓	✓	✓	✓	✓	✓	✓	✓	✓	✓	✓	✓	✓	✓	✓	✓	✓	✓	✓	✓		
	CG					✓	✓	✓	✓	✓	✓	✓	✓	✓	✓	✓	✓	✓	✓	✓	✓	✓	✓	✓	✓	✓	✓	✓	✓	✓	✓	✓	✓	✓	✓	✓	✓	✓	✓	✓	✓	✓	✓		

✓ Represents compatible modifications. Orders for cabinets with non-compatible modifications will not be processed. Please contact customer service for more details.
 *Consult Door Styles section for availability.

CONSTRUCTION OPTIONS

OPTION NAME	APPLICABLE CABINET GROUP	DESCRIPTION/LIMITATIONS	PRICING
Standard			
Laminate Ends (LE)	Most wall, base, tall, other room, and vanity cabinets	1/2" thick furniture board with natural Maple laminate interiors. Exteriors are laminate that match the color of the face frame.	Standard
Upgrades			
All-plywood Unfinished (APU)[†]	Most wall, base, tall, other room, and vanity cabinets	1/2" thick plywood end panels have a laminated natural Maple wood grain interior and unfinished exterior. End panels are routed to receive tops, bottoms and backs which are secured with adhesives and/or fasteners.	Cabinet list + 12%
Plywood Ends Unfinished (PEU)[†]	Most wall, base, tall, other room, and vanity cabinets	1/2" thick plywood end panels have a laminated natural Maple wood grain interior and unfinished exterior. End panels are routed to receive tops, bottoms and backs which are secured with adhesives and/or fasteners.	Cabinet list + 5%

ALL-PLYWOOD CONSTRUCTION (APU)[†]

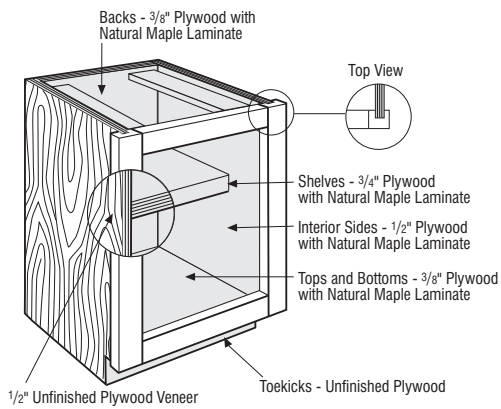

PLYWOOD ENDS CONSTRUCTION UPGRADE (PEU)[†]

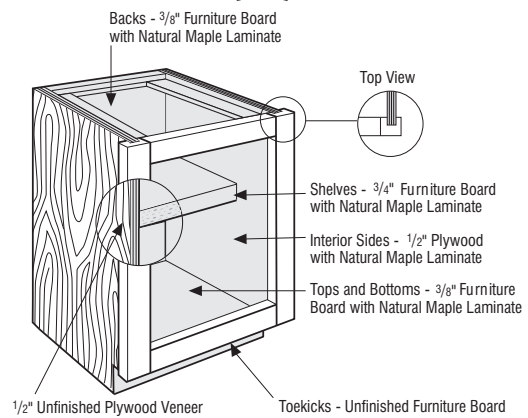

[†]All-plywood components meet ANSI/HPVA HP-1 standards and may contain MDF or particleboard.

DRAWER, ROLL TRAY, AND HINGE OPTIONS

OPTION NAME	APPLICABLE CABINET GROUP	DESCRIPTION/LIMITATIONS	PRICING
Drawer & Roll Tray			
Wood Dovetail Drawer w/SofTouch Guide (WDRW)	Cabinets with drawers	Four-sided clear coated solid hardwood drawer box with dovetailed construction and 5.2mm laminated plywood captured in drawer sides, front, and back. SofTouch features a self-closing, full extension mechanism, with a cushion close feature which prevents the drawer from slamming. Adjustable steel undermount full extension drawer guide system is completely hidden.	Standard
Wood Dovetail Roll Trays w/SofTouch Guide (RTPG)	Select base, tall, other room, and vanity cabinets	<p>On cabinets without a center stile, installs specified number of roll trays (1-5). Example, for two roll trays, specify 2RTPG.</p> <p>On cabinets with a center stile, installs a roll tray on both sides of the cabinet.</p> <p>1RTPG: 2 roll trays 3RTPG: 6 roll trays 2RTPG: 4 roll trays 4RTPG: 8 roll trays</p> <p>When 1RTPG is specified on a base cabinet, the roll tray is installed in the lowest position and one half-depth adjustable shelf is included.</p> <p>On utility cabinets for the lower section, 1RTPG includes three shelves, 2RTPG includes two shelves, and 3RTPG includes 1 shelf. No shelves for lower section are included with 4RTPG or 5RTPG. See page 45 for Roll Tray positions.</p>	\$208 per roll tray
Furniture Board Drawer (FDRW)	Cabinets with drawers and/or roll trays	<p>Replaces standard drawers, roll trays, and guides. 1/2" thick, four-sided construction with 3/8" thick bottom. Epoxy-coated steel drawer guides wrap around bottom 1/2" for added strength. All guides have a 75 lb. weight capacity. All drawers and roll trays must be changed in a cabinet.</p> <p>Not compatible with RD12 and RD15.</p>	Deduct \$32 list per drawer/roll tray

Hinge

Integrated SofTouch Hinge (INTGH)	Most cabinets with doors	Factory installed, 6-way adjustable hinge with integrated SofTouch feature.	Standard
Non SofTouch Hinge (NSCH)	Most cabinets with doors	Non SofTouch fully concealed cup hinge; 6-way adjustable and self-closing.	Deduct \$4 list per door

WOOD DOVETAIL ROLL TRAYS W/SOFTOUCH GUIDE (RTPG)

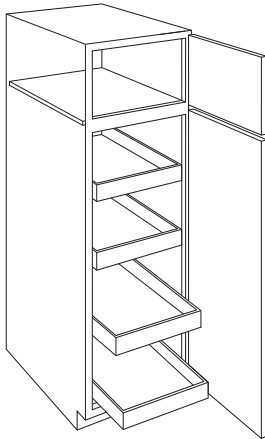

Tall cabinets

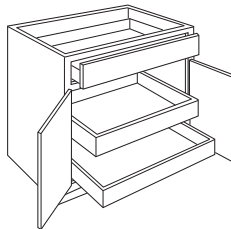

Base, Office, and Vanity cabinets

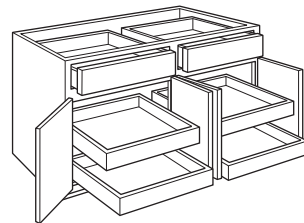

Base and Vanity cabinets with center stile

DRAWER FRONT OPTIONS

OPTION NAME	APPLICABLE CABINET GROUP	DESCRIPTION/LIMITATIONS	PRICING
Drawer Front			
Drawer Front Flat 5-piece (DFF5PC)	Base, tall, other room, and vanity cabinets on Arbor, Bexley, Bishop, Darwyn, Dover, Kendrick, Lautner, Piper, Rosedale, Sedona, Waldron (Wood Species Only), and Welzin	Replaces the standard drawer front with a 5-piece flat panel drawer front. Must upgrade all drawer fronts on a cabinet where applicable. Premium finish upcharges will apply where applicable.	\$90 list per drawer No Upcharge on Dover & Sedona

Place Standard Modification nomenclature AFTER cabinet nomenclature and include any size dimension needed.

5-PIECE DRAWER FRONT DIMENSIONS CHART

5-PIECE DRAWER FRONTS	DRAWER FRONT WIDTH	DRAWER FRONT HEIGHT	PANEL FLAT WIDTH	PANEL FLAT HEIGHT
Arbor DFF5PC (Wood)	7"	5 1/2"	2 1/2"	1 1/2"
Arbor DFF5PC (PureStyle™)	7"	5 1/2"	3"	1 1/2"
Bexley DFF5PC	8 1/2"	6 1/4"	3"	2 1/4"
Bishop DFF5PC	8 1/2"	6 1/4"	3 1/2"	1 1/4"
Darwyn DFF5PC (Wood)	8 1/2"	6 1/4"	2 1/2"	1 3/4"
Darwyn DFF5PC (PureStyle™)	8 1/2"	6 1/4"	4"	1 3/4"
Dover DFF5PC	8 1/2"	6 1/4"	2 1/2"	1 3/4"
Highland	8 1/2"	6 1/4"	3 1/2"	1 1/4"
Kendrick DFF5PC	8 1/2"	6 1/4"	4"	1 3/4"
Lautner DFF5PC	7"	5 1/2"	1 1/2"	1 1/2"
Piper DFF5PC	8 1/2"	6 1/4"	4"	1 3/4"
Rosedale DFF5PC	8 1/2"	6 1/4"	2 1/2"	1 3/4"
Sedona DFF5PC	8 1/2"	6 1/4"	4"	1 3/4"
Waldron DFF5PC (Wood)	8 1/2"	6 1/4"	2 1/2"	1 3/4"
Waldron (PureStyle™)	8 1/2"	6 1/4"	4"	1 3/4"
Welzin DFF5PC	8 1/2"	6 1/4"	4"	1 3/4"

Drawer front sizes are representative of a 9" wide base cabinet.

END PANEL MODIFICATIONS

MODIFICATION NAME	APPLICABLE CABINET GROUP	DESCRIPTION/LIMITATIONS	PRICING
Authentic Ends (AUTHL) (AUTHR) (AUTHB)	Wall, base, tall, other room, and vanity cabinets	<p>Modifies cabinet end panel(s) with applied decorative door(s) onto FPEB upgraded end panel(s).</p> <p>Includes FPEB modification; if AUTHL or AUTHR upgrades are specified, the opposite end panel is also FPEB.</p> <p>Available on most cabinets with depths of 12", 15", 18", 21", and 24".</p> <p>Other room base cabinets (29" high) will have double door configuration when specified on 24" deep cabinets.</p> <p>Tall mitered door styles and PureStyle™ door styles will feature one center panel, other door styles will feature two center panels.</p>	<p>AUTHL/AUTHR Wall: Cabinet list + \$275 list Base & Vanity: Cabinet list + \$375 list Tall: Cabinet list + \$975 list</p> <p>AUTHB Wall: Cabinet list + \$550 list Base & Vanity: Cabinet list + \$750 list Tall: Cabinet list + \$1950 list</p>
Finished Ends (FB)	Cabinets with APU or PEU modification; both ends will be finished	Creates a matching finished 1/2" veneer plywood exterior.	<p>Wall: Cabinet list + \$30 list Base: Cabinet list + \$60 list Tall: Cabinet list + \$90 list</p>
Furniture Finished Plywood Ends (FPEB)†	Wall, base, tall, other room, and vanity cabinets	Replaces standard cabinet ends with 3/4" finished veneer end panels to achieve a furniture end appearance. Not available with extended stiles or cabinets with frameless construction. APU upgrade available (Upcharges Apply).	<p>Wall: Cabinet list + \$75 list Base & Vanity: Cabinet list + \$150 list Tall: Cabinet list + \$300 list</p>

AUTHENTIC ENDS (AUTHB/AUTHL/AUTHR)

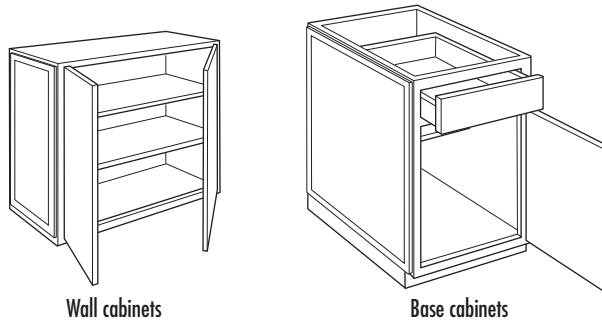

FURNITURE FINISHED PLYWOOD END PANELS CONSTRUCTION UPGRADE (FPEB)†

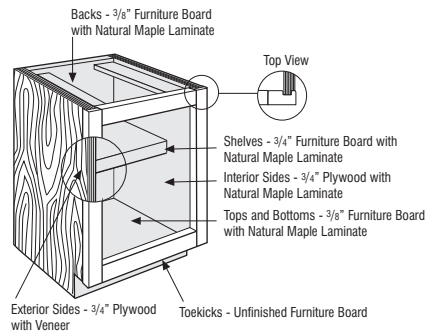

Place Standard Modification nomenclature AFTER cabinet nomenclature and include any size dimension needed.

†All-plywood components meet ANSI/HPVA HP-1 standards and may contain MDF or particleboard.

BOX MODIFICATIONS

MODIFICATION NAME	APPLICABLE CABINET GROUP	DESCRIPTION/LIMITATIONS	PRICING
Appliance Cut-out, Single (ACS)	Narrow Rail Oven Cabinets	Creates a custom cut-out area for field-ready oven installation. Available on oven cabinets specified with an (N) for Narrow Stile, with 1 1/2" wide frame side stiles. See cabinet specifications for available cut-out dimensions. Custom cut-out width dimension available in 1/4" increments. Standard frame opening will start 3" smaller than overall cabinet width. Custom cut-out opening can be specified from 3 1/2" to 6" smaller than the cabinet width in 1/4" increments. Cut-out opening will be centered. Custom cut-out height dimension available in 1/4" increments. Cut-out area will be centered.	Cabinet list + \$125 list
Cabinet Box Only (CBO)	Most wall, base, tall, other room, and vanity cabinets	Removes doors, drawer fronts, and any accessory items attached to a door or drawer front. Drawer box and any interior components attached to the cabinet box will be included. Frames will not be drilled for hinges.	Cabinets without drawers: 80% of cabinet list Cabinets with drawers: 85% of cabinet list
Cabinet Case Only (CCO)	Most wall, base, tall, other room, and vanity cabinets	Removes doors, drawer fronts, drawers, and interior components. Frames will not be drilled for hinges, but cabinet will have standard drilling for shelves and guides.	80% of cabinet list
Cabinet Front Only (CFNTO)	Most wall, base, tall, other room, and vanity cabinets	Creates a door and/or drawer front assembled with a frame.	65% of cabinet list
Cabinet Frame Only (CFRMO)	Most cabinets with a face frame	Creates a cabinet frame only. No box, doors, or drawer fronts are included.	25% of cabinet list

APPLIANCE CUT-OUT, SINGLE (ACS)

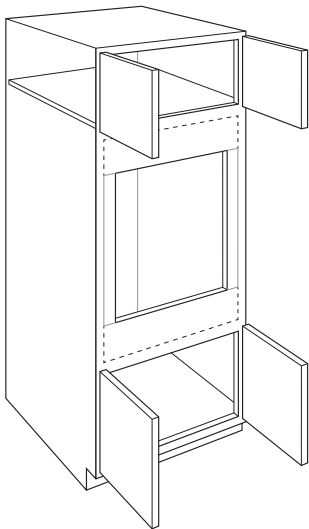

Tall cabinets

CABINET BOX ONLY (CBO)

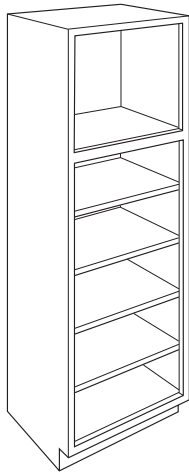

Tall cabinets

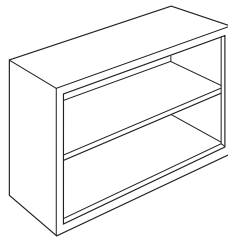

Wall cabinets

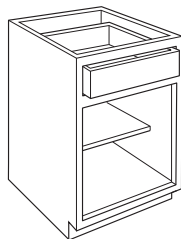

Base cabinets

CABINET CASE ONLY (CCO)

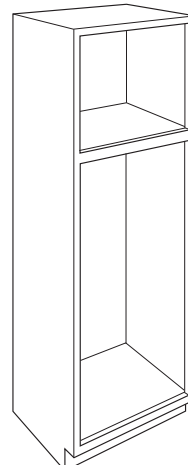

Tall cabinets

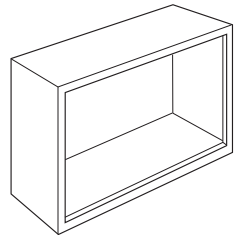

Wall cabinets

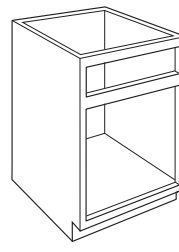

Base cabinets

CABINET FRONT ONLY (CFNTO)

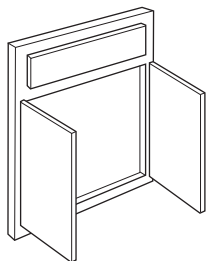

Wall, Base, and Tall cabinets

CABINET FRAME ONLY (CFRMO)

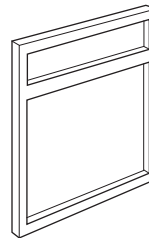

Cabinet frame only – Wall, Base, and Tall

Place Standard Modification nomenclature AFTER cabinet nomenclature and include any size dimension needed.

BOX MODIFICATIONS (cont'd)

MODIFICATION NAME	APPLICABLE CABINET GROUP	DESCRIPTION/LIMITATIONS	PRICING
Cabinet False Panel (CFP)	Most base, tall, other room, and vanity cabinets with a top drawer	Replaces top drawer with false panel. Not available with deep drawers.	No Upcharge
Cabinet with No Door, with Drawer (CND)	Most wall, base, tall, other room, and vanity cabinets with door(s) and drawer(s)	Removes door(s). Complete drawer(s) with drawer front(s) and interior components remain in cabinet. Frames will not be drilled for hinges.	90% of cabinet list
Extended Stile (EXL) (EXR)	Most cabinets with a face frame	Creates up to 3" extended stile beyond its normal face frame width to achieve an overall frame width of 4 1/2". Stiles can be extended in 1/2" increments up to 3" per side. To extend a single stile, specify EXL or EXR.	Wall & Base: \$75 list per side Tall: \$200 list per side Both: Above price x 2
Increased Depth (ID)*	Most wall, other room, and vanity cabinets	Increases the depth of wall cabinets to 15", 18", 21", or 24", bookcases to 15", and vanities to 24".	Cabinets without drawers: Cabinet list + \$150 list Cabinets with drawers: Cabinet list + \$200 list
	Most panels	Increases the depth in 3" increments to 30".	List + 12%
	Column box fillers	Increases the depth in 3" increments to 27".	List + 20%

CABINET FALSE PANEL (CFP)

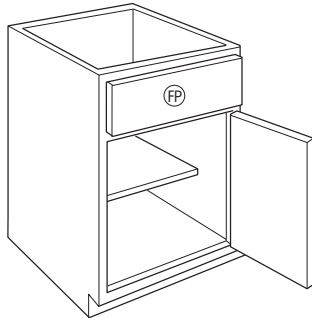

Base and Vanity cabinets

CABINET WITH NO DOOR, WITH DRAWER (CND)

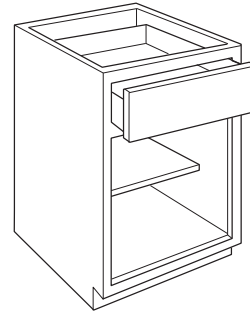

Base and Vanity cabinets

EXTENDED STILE LEFT (EXL)

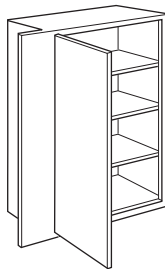

EXTENDED STILE RIGHT (EXR)

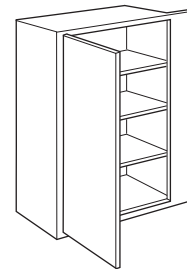

INCREASED DEPTH (ID)

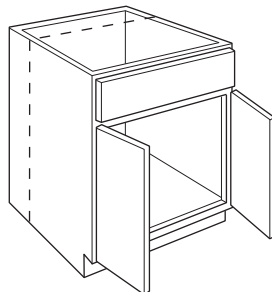

Vanity cabinets

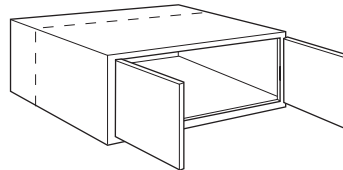

Wall cabinets

Place Standard Modification nomenclature AFTER cabinet nomenclature and include any size dimension needed.

*We recommend that all Increased Depth wall cabinets be installed with a minimum of three points of support, including at least one (or both) cabinet sides and either the cabinet top or the cabinet back.

BOX MODIFICATIONS (cont'd)

MODIFICATION NAME	APPLICABLE CABINET GROUP	DESCRIPTION/LIMITATIONS	PRICING
Reduced Depth (RD)	Most base, tall, other room, and vanity cabinets with drawers	Reduces the depth of base cabinets to 21", 18", 15", or 12". Talls can be reduced to 21" or 18". Any specified shelving is included and is always full depth.	Cabinet list + \$200 list (Vanity RD18 no charge)
	Most wall, base, tall, other room, and vanity cabinets without drawers	Reduces the depth of wall cabinets to 9" or 6" and base cabinets without drawers to 21", 18", 15", or 12". Any specified shelving is included and is always full depth.	Cabinet list + \$150 list (Vanity RD18 no charge)
	Most end panels	Reduces the depth on most 12" deep panels, 9" or 6". Reduces the depth on most 24" deep panels, 21", 18", 15", or 12".	List + 12%
	Column box fillers	Reduces the depth in 3" increments to 6".	List + 12%
	Roll trays	Base cabinets - Reduced depth available on RTPG to 21", 18", 15", or 12". FDRW can be reduced to 21" or 18". Utility cabinets - Reduced depth available to 21" or 18".	Per tray + \$50 list
Peninsula (P)	Most wall and select base cabinets	Creates a peninsula cabinet that is 1/4" deeper than the standard cabinet depth. If ID or RD is specified, cabinet will be 1/4" deeper than specified cabinet depth. Not available on multi-drawer base cabinets. Any cabinet with a toekick must be at least 15" deep (either standard with toekick or when ADDTK is specified). Any adjustable shelves are upgraded to full depth. A false drawer front will be placed on the back of a standard base cabinet modified to a peninsula base. Single door cabinets are hinged on the same cabinet end, for example a W1230L will feature a Left hinge on the front side and a Right hinge on the peninsula side. Peninsula cabinets are not designed to be used as stand alone island cabinets. The maximum depth for wall cabinets with the Peninsula modification is 18".	Cabinet list + 75%

PENINSULA (P)

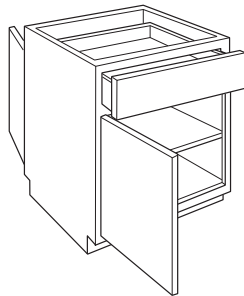

Base cabinets

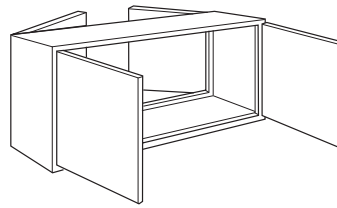

Wall cabinets

REDUCED DEPTH (RD)

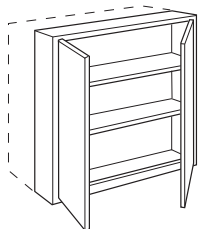

Wall cabinets

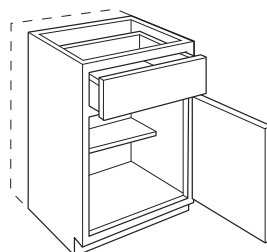

Base cabinets

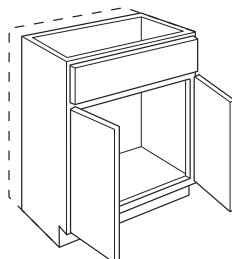

Vanity cabinets

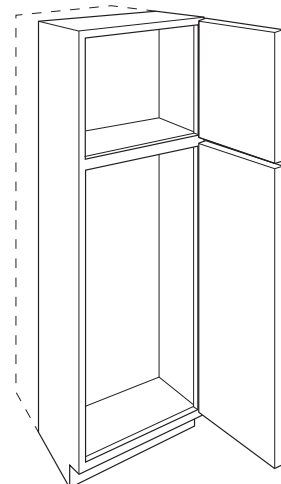

Tall cabinets

Place Standard Modification nomenclature AFTER cabinet nomenclature and include any size dimension needed.

OVERLAY MODIFICATIONS

MODIFICATION NAME	APPLICABLE CABINET GROUP	DESCRIPTION/LIMITATIONS	PRICING
Full Overlay (FULL)	Full Overlay door styles	The door and drawer fronts overlay the frame, exposing 1/4" on the top and bottom rails and right and left stiles of base cabinets. Typical base units with a center stile expose 1/2" of that stile.	No Upcharge
Modified Full Overlay (MFO)	Full Overlay door styles of wall and tall cabinets	<p>Wall and Tall Cabinets: The door and drawer fronts overlay the frame, exposing 1/4" on the bottom rail and right and left stile. One full inch is exposed on the top rail of wall and tall cabinets. Typical units with a center stile expose 1/2" of that stile.</p> <p>Base Cabinets: The door and drawer fronts overlay the frame, exposing 1/4" on the top and bottom rails and right and left stiles of base cabinets. Typical base units with a center stile expose 1/2" of that stile.</p> <p>MFO modification allows for face mount moulding application.</p> <p>Overlay Fillers are available in MFO heights to align with doors, see pages 146-147 for OL..MFO.</p>	No Upcharge
Traditional Overlay	Traditional Overlay door styles	The door and drawer fronts overlay the face frame 1/2", exposing 1" of the frame both on the stile and rail members. Typical wall and base cabinets with a center stile expose 2" of that stile.	No Upcharge

FULL OVERLAY (FULL)

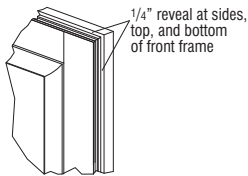

MODIFIED FULL OVERLAY (MFO)

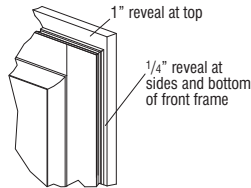

Modified Full Overlay (Wall and Tall)

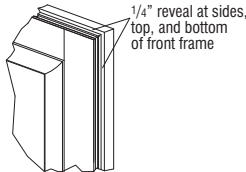

Modified Full Overlay (Base)

TRADITIONAL OVERLAY

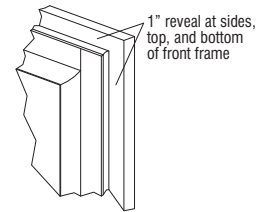

INTERIOR MODIFICATIONS

MODIFICATION NAME	APPLICABLE CABINET GROUP	DESCRIPTION/LIMITATIONS	PRICING
Matching Interior (MI)	Most cabinets	Modifies the cabinet interior and end panel exterior to matching finished veneer plywood. Cabinet top and bottom exterior on wall cabinets is also matching finished veneer plywood. Construction features veneered plywood with full depth shelves of veneer on a plywood core. Side and back panel edges will be unfinished.	Cabinet list + 30%
Full Depth Shelf (FD)	Most base cabinets; select other room cabinets	Replaces standard shelf with a full depth shelf.	Cabinet list + \$75 list

32

MATCHING INTERIOR (MI)

- matching finished veneer
- standard matching finished component
- standard non-matching finished component

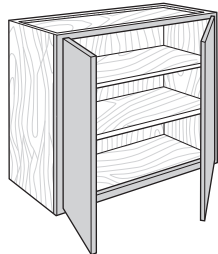

Wall cabinets

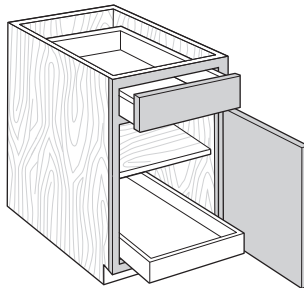

Base cabinets

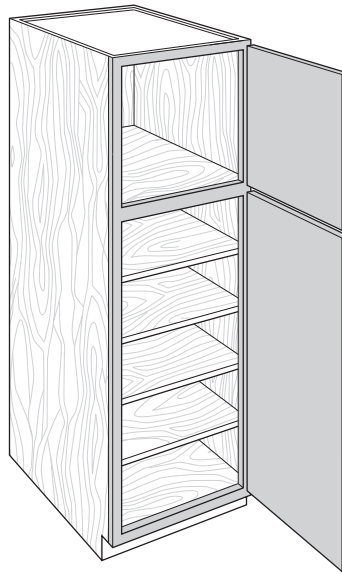

Tall cabinets

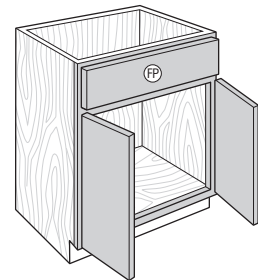

Vanity cabinets

FULL DEPTH SHELF (FD)

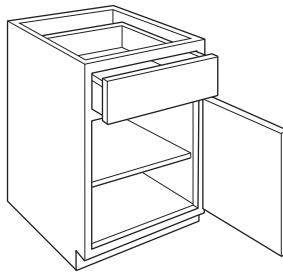

INTERIOR MODIFICATIONS

Place Standard Modification nomenclature AFTER cabinet nomenclature and include any size dimension needed.

TOEKICK MODIFICATIONS

MODIFICATION NAME	APPLICABLE CABINET GROUP	DESCRIPTION/LIMITATIONS	PRICING
Add Toekick (ADDTK)	Most wall cabinets	Creates a 4 1/2" high toekick on the front of the cabinet. Available with ID on depths 9" or greater.	Cabinet list + \$150 list
Flush Toekick (FTK)	Most wall, base, tall, other room, and vanity cabinets	Extends the face frame to the floor eliminating the toe space. When FTK is ordered with the Peninsula modification, both sides will receive a flush toekick.	Cabinet list + \$200 list
Flush Toekick Arch (FTKAV)	Most wall, base, tall, and vanity cabinets	Creates an arch flush toe space. Valance replaces standard toekick creating a full open area beneath cabinet floor. When FTKAV is ordered with the Peninsula modification, both sides will receive an arch flush toekick. Not available on 9" or 12" wide cabinets.	Cabinet list + \$225 list
Flush Toekick Furniture (FTKFV)	Most wall, base, tall, and vanity cabinets	Creates a furniture flush toe space. Valance replaces standard toekick creating a full open area beneath cabinet floor. When FTKFV is ordered with the Peninsula modification, both sides will receive a furniture flush toekick. Not available on 9" or 12" wide cabinets.	Cabinet list + \$225 list

ADD TOEKICK (ADDTK)

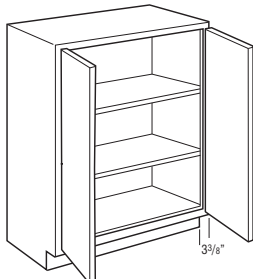

Wall cabinets

FLUSH TOEKICK (FTK)

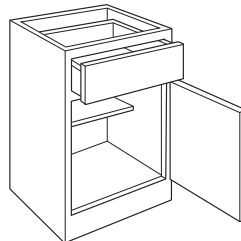

Base cabinets

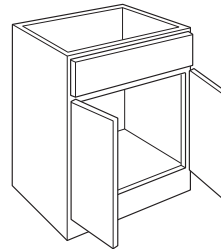

Vanity cabinets

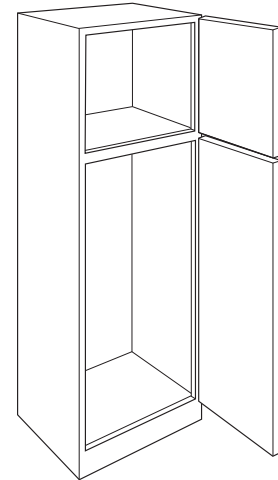

Tall cabinets

FLUSH TOEKICK ARCH (FTKAV)

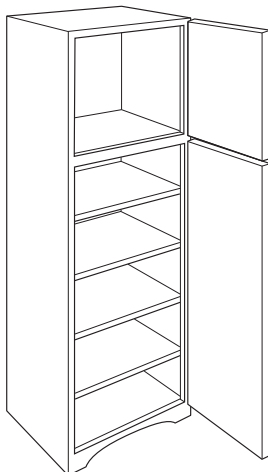

Tall cabinets

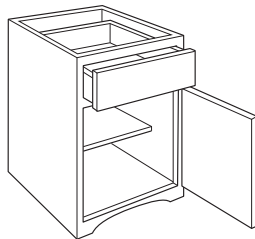

Base cabinets

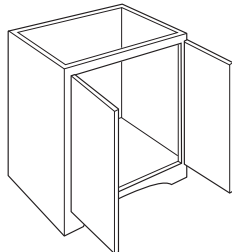

Vanity cabinets

FLUSH TOEKICK FURNITURE (FTKFV)

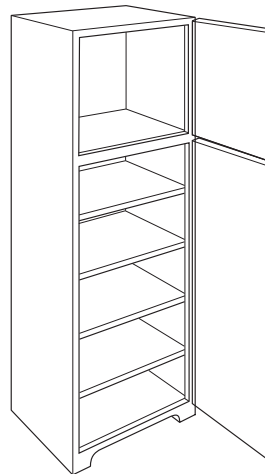

Tall cabinets

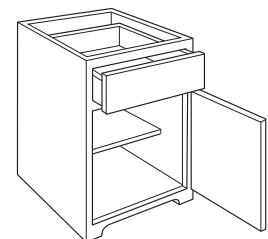

Base cabinets

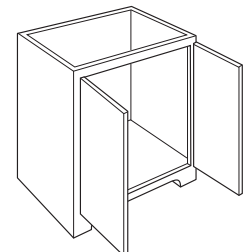

Vanity cabinets

Place Standard Modification nomenclature AFTER cabinet nomenclature and include any size dimension needed.

TOEKICK MODIFICATIONS (cont'd)

MODIFICATION NAME	APPLICABLE CABINET GROUP	DESCRIPTION/LIMITATIONS	PRICING
Recessed Toekick (RECTKBK) (RECTKL) (RECTKR)	Most wall, base, tall, other room, and vanity cabinets	Creates a recessed toekick on the back (RECTKBK), left (RECTKL), or right (RECTKR). Available on wall cabinets when ADDTK is specified.	Cabinet list + \$175 list per side
Island Toekick (RECTKALL)	Base cabinets 27"-48" wide, 24" deep	Creates island toekick (toekick all 4 sides).	Cabinet list + \$425 list
Void Toekick (VTK)	Most base, tall, other room, and vanity cabinets	Removes the toekick. Only available when the cabinet has a standard toekick (not available when flush toekick is standard or when cabinet has a separate pedestal base).	Cabinet list + \$74 list

RECESSED TOEKICK LEFT (RECTKL)

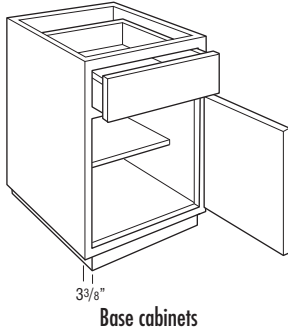

RECESSED TOEKICK RIGHT (RECTKR)

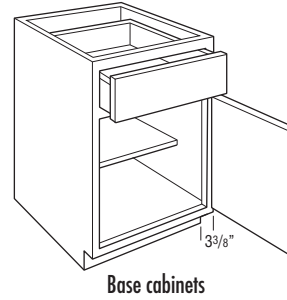

RECESSED TOEKICK BACK (RECTKBK)

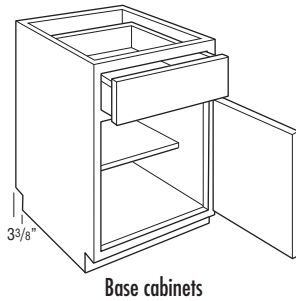

ISLAND TOEKICK (RECTKALL)

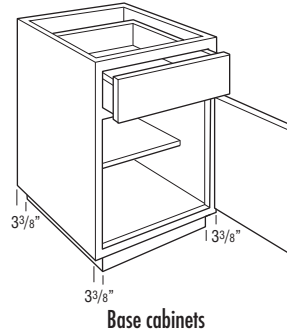

VOID TOEKICK (VTK)

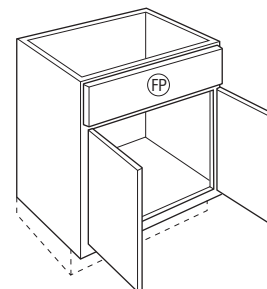
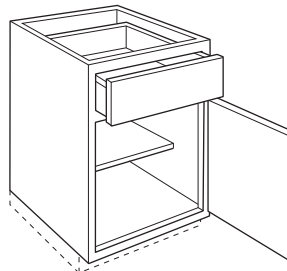
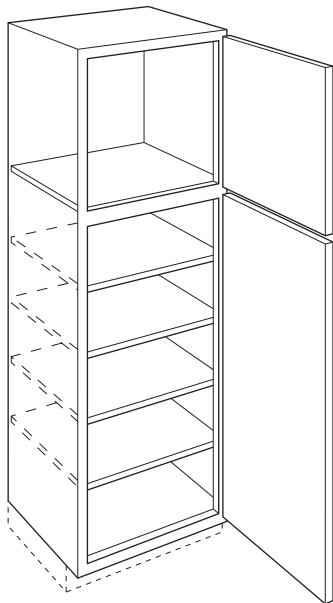

Place Standard Modification nomenclature AFTER cabinet nomenclature and include any size dimension needed.

MULLION DOORS

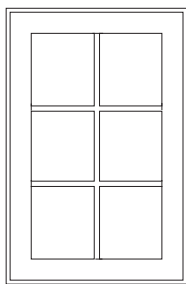

- To price mullion doors attached to a cabinet, add door only price to the wall cabinet price.

Mullion Door Pricing (price does not include glass)

Cabinet Height

- Doors up to 30" High \$140 list per door
- Doors 30" to 36" High \$160 list per door
- Doors over 36" High \$180 list per door

- For a door only (not specified on a cabinet), add the list price for a door only to the Mullion door list price. See Doors and Drawer Fronts on page 177 for details.
- Available with optional clear or textured glass, see page 37.
- Mullion cabinets are shipped with retainer clips, although a preferred method of installation is the use of a silicone adhesive (not supplied).
- When ordered as standard construction, cabinet will have standard interior **unless** ordered with MI option.
- When ordering upgraded construction, cabinet automatically will be ordered with MI. Upcharges apply.
- All textured glass panels will be drop shipped separately from the cabinet order.
- Glass installation clips will ship with the doors and/or cabinets.
- The use of glass for base cabinet applications or for placement near interior or exterior doors is not recommended.
- See Door Options grid for availability.
- Chalet not available with Mullion Doors.

MULLION LITES GRID

Cabinet Width	Cabinet Height							
	15"	18"	24"	30"	33"	36"	39"	42"
W15	4	4	4	6	6	6	8	8
W18	4	4	4	6	6	6	8	8
W21	4	4	4	6	6	6	8	8
W24	4	4	4	6	6	6	8	8
W24 (butt)	4	4	4	6	6	6	8	8
W27 (butt)	4	4	4	6	6	6	8	8
W30 (butt)	4	4	4	6	6	6	8	8
W33 (butt)	4	4	4	6	6	6	8	8
W36 (butt)	4	4	4	6	6	6	8	8
W42 (2 door)	4	4	4	6	6	6	8	8
W45 (2 door)		4	4	6	6	6	8	8
W48 (2 door)		4	4	6	6	6	8	8
W48 (4 door)	4							
WD	4	4	4	6	6	6	8	8

STACKED WALL SPECIALTY DOOR OPTIONS

Model	CGCG SDCG	CGSD SDSD	MDMD SDMD	MDSD
STW12		✓		
STW15-42		✓		✓
STWD24-27		✓		✓

When ordering Specialty Doors for Stacked Wall Cabinets, please refer to the above chart for availability. Nomenclature represents top then bottom door options. See example below for details.

Ex. **SDMD**
 Top Door Bottom Door
 SD = Standard Door
 MD = Mullion Door
 CG = Cut-for-glass

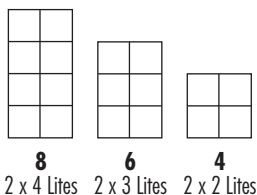

CUT-FOR-GLASS DOORS

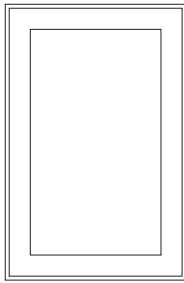

- To price Cut-for-glass Doors attached to the cabinet, add door only price to the wall cabinet price.

Cut-for-glass Door Pricing (price does not include glass)

Cabinet Height

- Doors up to 30" High \$100 list per door
- Doors 30" to 36" High \$120 list per door
- Doors over 36" High \$140 list per door

- For a door only (not specified on a cabinet), add the list price for a door only to the Cut-for-glass door list price. See Doors and Drawer Fronts on page 177 for details.
- Cut-for-glass cabinets are shipped with retainer clips, although a preferred method of installation is the use of a silicone adhesive (not supplied).
- When ordered as standard construction, cabinet will have standard interior **unless** ordered with MI option.
- When ordering upgraded construction, cabinet automatically will be ordered with MI. Upcharges apply.
- Glass not included, see page 37 for glass options.
- All textured glass panels will be drop shipped separately from the cabinet order.
- Glass installation clips will ship with the doors and/or cabinets.
- The use of glass for base cabinet applications or for placement near interior or exterior doors is not recommended.
- See Door Options grid for availability.
- Chalet not available with Cut-for-glass Doors.

STANDARD WALL CABINET AVAILABILITY*

Cabinet Width	Cabinet Height											
	12"	15"	18"	21"	24"	27"	30"	33"	36"	39"	42"	
W9							✓	✓	✓	✓	✓	
W12	✓	✓	✓	✓	✓	✓	✓	✓	✓	✓	✓	
W15	✓	✓	✓	✓	✓	✓	✓	✓	✓	✓	✓	
W18	✓	✓	✓	✓	✓	✓	✓	✓	✓	✓	✓	
W21	✓	✓	✓	✓	✓	✓	✓	✓	✓	✓	✓	
W24	✓	✓	✓	✓	✓	✓	✓	✓	✓	✓	✓	
W24 (butt)	✓	✓	✓	✓	✓	✓	✓	✓	✓	✓	✓	
W27 (butt)	✓	✓	✓	✓	✓	✓	✓	✓	✓	✓	✓	
W30 (butt)	✓	✓	✓	✓	✓	✓	✓	✓	✓	✓	✓	
W33 (butt)	✓	✓	✓	✓	✓	✓	✓	✓	✓	✓	✓	
W36 (butt)	✓	✓	✓	✓	✓	✓	✓	✓	✓	✓	✓	
W39 (2 door)	✓	✓	✓	✓	✓	✓	✓	✓	✓	✓	✓	
W42 (2 door)		✓	✓	✓	✓	✓	✓	✓	✓	✓	✓	
W45 (2 door)			✓	✓	✓	✓	✓	✓	✓	✓	✓	
W48 (2 door)			✓	✓	✓	✓	✓	✓	✓	✓	✓	
W42 (4 door)	✓	✓										
W45 (4 door)	✓	✓										
W48 (4 door)	✓	✓										
WD	✓	✓	✓		✓	✓	✓	✓	✓	✓	✓	

STACKED WALL SPECIALTY DOOR OPTIONS

Model	CGCG SDCG	CGSD SDSD	MDMD SDMD	MDS
STW12		✓		
STW15-42		✓		✓
STWD24-27		✓		✓

When ordering Specialty Doors for Stacked Wall Cabinets, please refer to the above chart for availability. Nomenclature represents top then bottom door options. See example below for details.

Ex. **SDMD**
 Top Door Bottom Door
 SD = Standard Door
 MD = Mullion Door
 CG = Cut-for-glass

*For Specialty Wall Cabinet and Oven Cabinet Availability, please see modification grid.

TEXTURED GLASS PANELS



Clear (CLEAR)



Bevel (BEVEL)*



Frost (FROST)

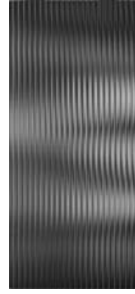

Reeded (REEDE)



Seeded (SEEDE)

TEXTURED GLASS PANELS	PANEL THICKNESS	LIST PER DOOR 12"-30" TALL	LIST PER DOOR 33"-42" TALL
Clear	1/8"	100	130
Bevel	1/4"	195	215
Frost	5/32"	195	215
Reeded	5/32"	165	181
Seeded	1/8"	307	338

- Mullion doors or Cut-for-glass doors must be ordered separately. See pages 35-36.
- Mullion doors available with Clear, Frost, Reeded, or Seeded glass.
- On order acknowledgment, W3030B (cabinet description), CG-MD (door style description), Clear (glass nomenclature).
- Door frame may reduce the amount of glass shown.
- When textured glass is ordered for use in wall top hinge (WTH) cabinets, the glass design will be turned horizontally and may not match the desired pattern.
- All textured glass panels will be drop shipped separately from the cabinet order.
- Glass installation clips will ship with the doors and/or cabinets.
- The use of glass for base cabinet applications or for placement near interior or exterior doors is not recommended.

CUSTOM CHOICE CABINETS

With Homecrest's flexible manufacturing capabilities, Homecrest is able to produce cabinets and appliance cabinets & panels not listed in the price and specification guide. To utilize this process, please use the following procedures.

Cabinets

- Complete the Custom Choice Request Form and provide a detailed drawing, including dimensions of the Custom Choice cabinet. Submitting a floor plan may reduce questions that arise during the engineering process.
- Fax (800.737.7800) or email (hccr@masterbrand.com) the Custom Choice Request Form to the Homecrest Customer Service Department.
- Approved custom configurations will be quoted and assigned a Custom Choice number. This information will be emailed to you. Engineering requires 48 hours to process the request and develop a quote.
- When placing the order, please include the Custom Choice number on the Homecrest Order Form.

Notes

- Custom Choice items cannot be changed or cancelled once the order is placed.
- If specifications are altered, the Custom Choice item will need to be quoted again.
- Examples of custom cabinet configurations can be found on pages 41-43.

Appliance Cabinets & Panels

- Appliance specifications are required from the designer.
- Fax (800.737.1500) or email (hccr@masterbrand.com) the Custom Choice Request Form to the Homecrest Customer Service Department.
- Engineering requires 48 hours to process the request and develop a quote. To expedite this process, please use the Custom Request Forms on pages 39 & 40.

CUSTOM CHOICE PRODUCT GUIDELINES

Cabinet Dimensions

- Frames cannot be larger than 42" x 60" or 60" x 42".
- Adjustable shelves not available in cabinets wider than 36" without a center vertical.
- Maximum depth on tall cabinets and cabinets with drawers is 24".
- Maximum width:
 - bases - 60"
 - walls - 48"
 - talls - 36"
- Maximum height is 96".
- Frame angles cannot be altered or changed.

Doors (see pages 178-179 for custom door SKUs)

- Custom doors are no longer required to run through the Custom Choice program. Fill out the section on the standard order form and they will be processed with your normal order.

Drawer Fronts

- Custom Drawer Fronts not available in Chalet, Fyfer, or Piper. Limitations exist on all styles.
- Custom drawer fronts are not available for cabinets not manufactured by Homecrest.
- Mixed drawer fronts on a cabinet are not available.

Drawers

- Drawers & Roll Trays available in existing sizes only.
- Minimum depth for drawers is 12".
- Maximum depth for drawers is 24".

Other

- Applied mouldings not available.
- Countertops not available.
- Unfinished cabinets or finishes not in our standard offering not available.

Custom Request Form

Phone # 1-855-722-2148
Fax # 1-800-737-1500

Email: hccr@masterbrand.com

**Custom Cabinet Requests should be submitted 48 hours prior to order placement.
A Custom Number and List Price will be emailed to you.
The Custom Number and Quantity should be included on the order.**

Dealer Information	
Date:	Account Name:
Account Code # (required):	Contact Name:
Tag:	Contact Phone #:
	Contact Email Address:
Product Information	
Door Style:	Wood Species:
Color:	Glaze:
Hinge Type: <input type="checkbox"/> INTGH <input type="checkbox"/> NSCH	
Hinge Position: <input type="checkbox"/> Left <input type="checkbox"/> Right	
Drawer Box / Roll Tray: <input type="checkbox"/> WDRW <input type="checkbox"/> RTPG <input type="checkbox"/> FDRW	
Drawer Front: <input type="checkbox"/> Slab <input type="checkbox"/> 5-piece	
Overlay Modification: <input type="checkbox"/> Full <input type="checkbox"/> Modified Full <input type="checkbox"/> Traditional (select one)	
Construction Options: <input type="checkbox"/> Laminate Ends <input type="checkbox"/> Plywood Unfinished Ends <input type="checkbox"/> All-plywood Unfinished Ends (select one)	
Other Modifications: <input type="checkbox"/> Finished Ends <input type="checkbox"/> Furniture Finished Plywood Ends Both <input type="checkbox"/> Matching Interior	
Description of Request	

Complete and accurate information will help ensure a timely turnaround and assist Homecrest Cabinetry in determining quote feasibility. Homecrest Cabinetry maintains authority to approve or deny Custom Choice™ requests.

Custom Appliance Cabinets and Panels Worksheet.

This worksheet must be submitted with Cover Sheet for quoting to Customer Service.

Note: All preferences will be considered and standard cabinet components will be used. The microwave/oven opening size will determine top cabinet size.

Microwave Cabinet

Overall cabinet size:

- A. _____ width
- B. _____ height
- C. _____ depth
- 1. Top cabinet (preferred height)
- D. _____ height
- 2. Microwave (opening required)
- E. _____ width
- F. _____ height
- 3. Actual microwave specs
- G. _____ width
- H. _____ height
- 4. Overall trim kit size
- I. _____ width
- J. _____ height
- 5. Drawer height
- K. _____ height

Will microwave be
(built in) or (set in)?
Please circle.

Extended (past cabinet bottom)
Microwave Shelf -
for 12" deep wall cabinet only.
_____ yes _____ no

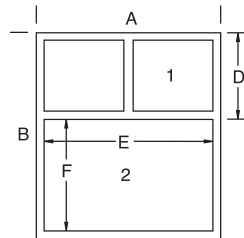
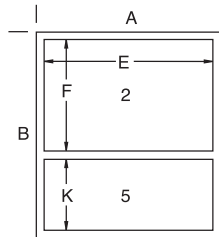
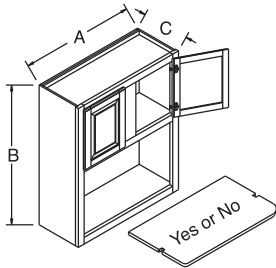

Oven Cabinet

Note: Oven cutouts are used to determine cabinet configuration. Whenever possible BD30D drawers will be used unless otherwise specified. Finished oven width may need to be cut on job site.

Cabinet Size:

- A. _____ width
- B. _____ height

Wish List:

- 1. Top cabinet (preferred)
- C. _____ height
- 2. Microwave opening (option 2 only: will microwave be built-in or set-in?)
- D. _____ width
- E. _____ height

Wish List determined by this:

- 3. Oven opening (no standard)
- F. _____ width
- G. _____ height
- 4. Overall trim kit size
- H. _____ width
- I. _____ height
- 5. Bottom cabinet

Prefer doors:

Doors: _____ yes or no _____

Number of drawers _____

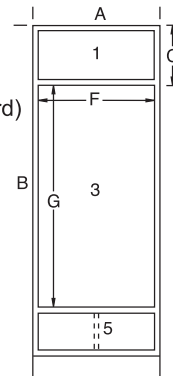

Single Oven
Option 1

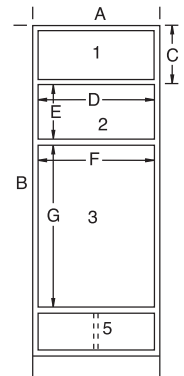

Oven/Microwave
Combination
Option 2

Refrigerator Panels

Manufacturer Backer Panel Sizes Required: Manufacturer Door Sizes Required:

- 1. A. _____ width
- B. _____ height
- 2. A. _____ width
- B. _____ height
- 3. A. _____ width
- B. _____ height

Grille (Top or Bottom) -

Optional for all configurations

- 4. A. _____ width
- B. _____ height

- 1. A. _____ width
- B. _____ height
- 2. A. _____ width
- B. _____ height
- 3. A. _____ width
- B. _____ height

Grille (Top or Bottom) -

Optional for all configurations

- 4. A. _____ width
- B. _____ height

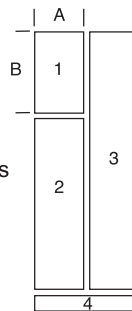

Sub Zero

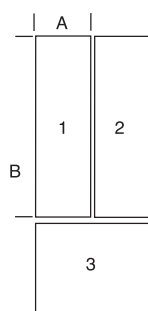
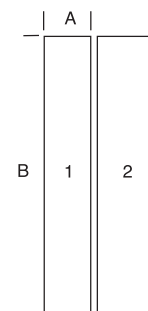

French Door

INTEGRATED WALL UNITS

Whenever possible, it is aesthetically pleasing and will reduce installation time to combine two stacked cabinets into one integrated face frame.

REQUEST A QUOTE

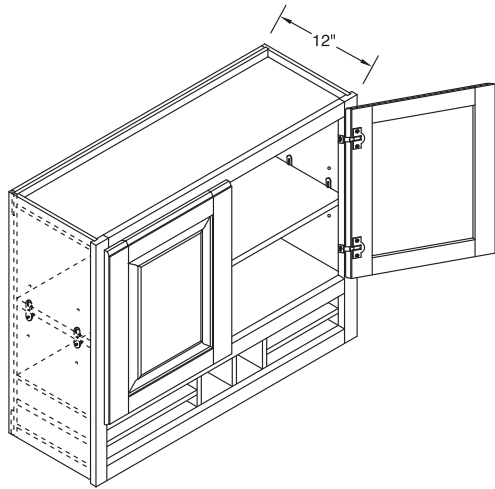

Wall cabinet with integrated organizer behind the face frame.

REQUEST A QUOTE

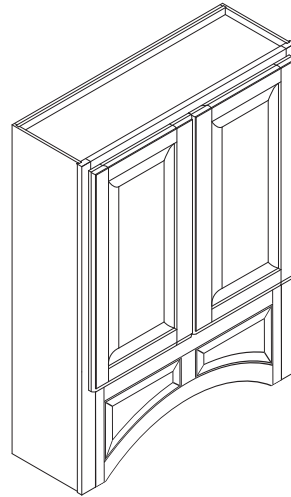

WALL CABINET STORAGE IDEAS

REQUEST A QUOTE

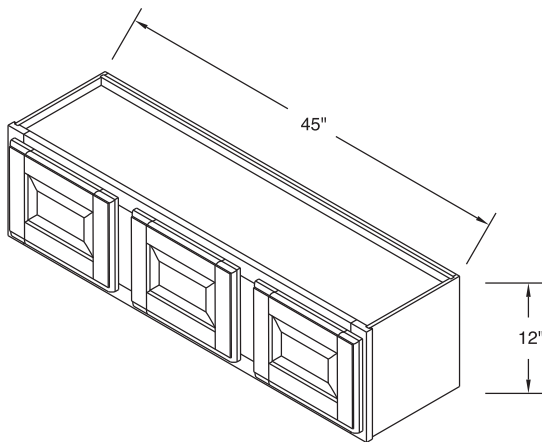

REQUEST A QUOTE

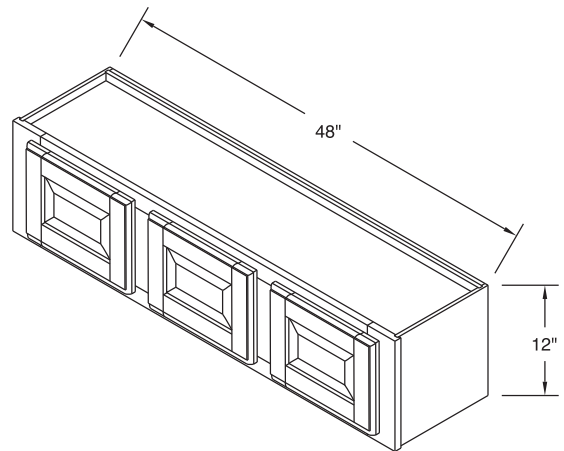

When extending the width of a cabinet, consider adding a third door.
Need to specify hinging (i.e. LLR or LRR).

BASE CABINETS

REQUEST A QUOTE

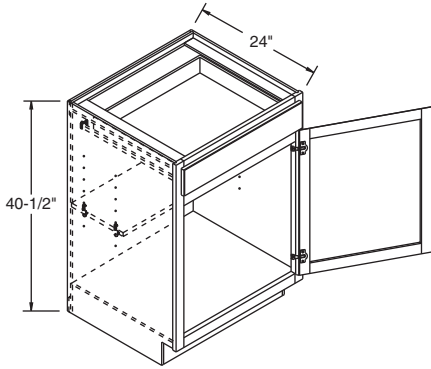

REQUEST A QUOTE

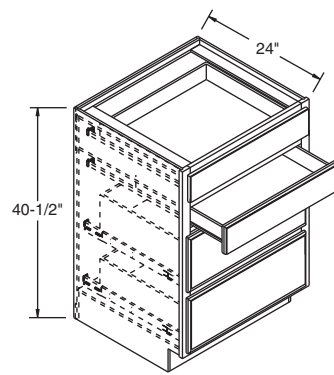

BASE CABINETS

REQUEST A QUOTE

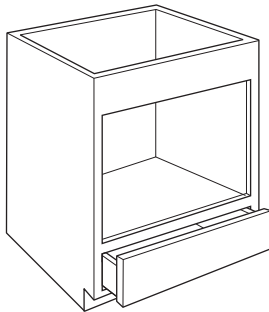

Custom Appliance Cabinet:
Using your appliance specifications, create a custom microwave from a standard microwave cabinet.

DECORATIVE TUB FRONT

REQUEST A QUOTE

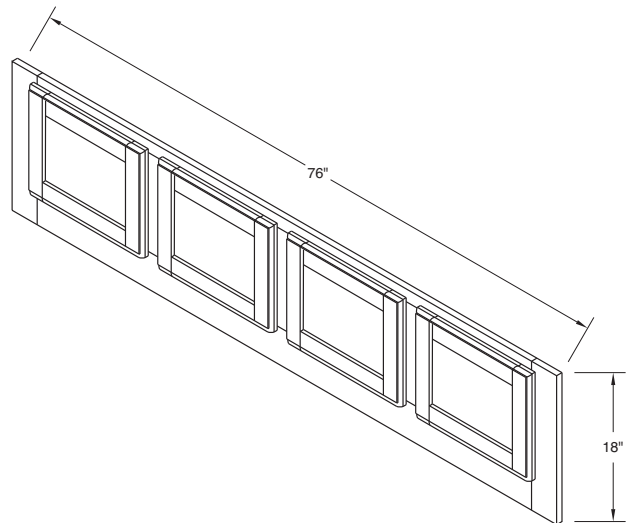

VANITY CABINETS

REQUEST A QUOTE

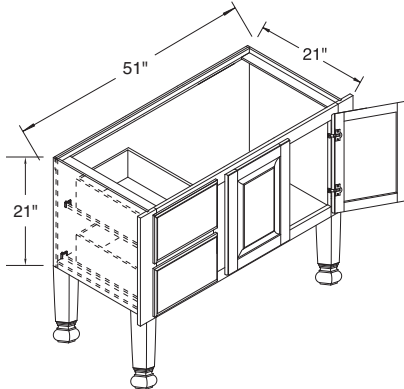

REQUEST A QUOTE

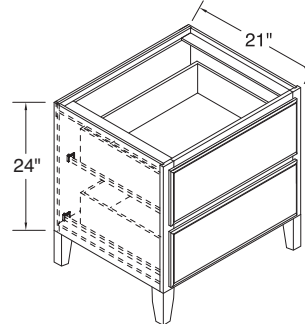

TALL CABINETS

REQUEST A QUOTE

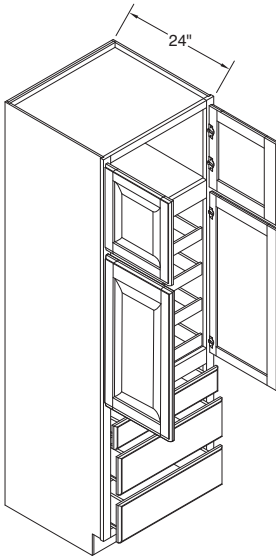

REQUEST A QUOTE

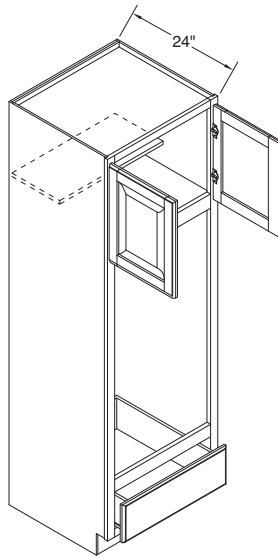

Custom Appliance Cabinet:
Using your appliance specifications, create a custom microwave/oven unit from a universal oven cabinet.

REQUEST A QUOTE

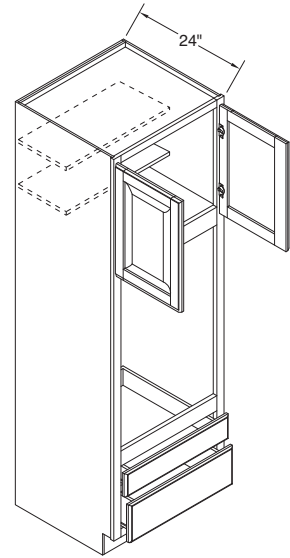

Custom Appliance Cabinet:
Using your appliance specifications, create a custom microwave/oven unit from a universal oven cabinet.

43

STORAGE IDEAS

REQUEST A QUOTE

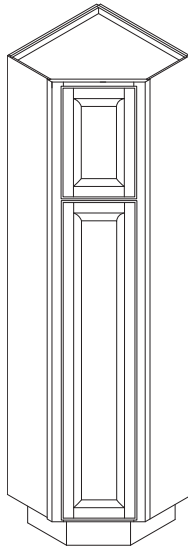

Custom Utility Cabinet:
Turn often wasted corners of any master bath into closet or utility cabinet storage.

REQUEST A QUOTE

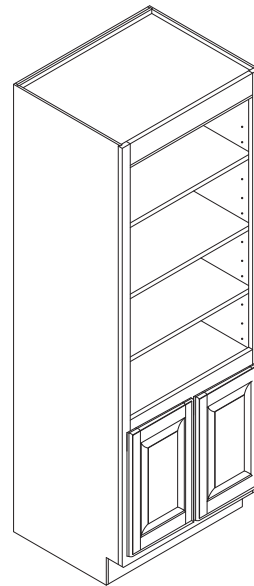

Shelf Units:
Enhance the open shelf unit with cabinet doors. Field applied Soffit A moulding to any of the shelves creates a plate rail.

CUSTOM CHOICE™ CABINETS

CABINET DIMENSIONS

- Shown are the dimensions for the stiles and rails of Homecrest cabinets. The opening sizes change based on the width and height of each individual cabinet, while the stile and rail sizes remain fairly consistent.
- To determine the horizontal opening measurement, subtract the stiles (and center stile on 39" wide and larger) from the cabinet width. To determine the vertical opening, subtract the rail measurements from the cabinet height.
- The face frame dimension is given for base, vanity, desk and tall units. To determine the overall cabinet height, add Homecrest's standard 4 1/2" high toekick to the vertical dimension of face frame.

DOOR SIZING AND REVEALS

- **Traditional Overlay Doors:** The doors and drawer fronts overlay the face frame 1/2", exposing 1" of the frame both on the stile and rail members. Typical wall and base cabinets with a center stile expose 2" of that stile.
- **Modified Full Overlay Doors**
(Wall and Tall Cabinets): The door and drawer fronts overlay the frame, exposing 1/4" on the bottom rail and right and left stile. One full inch is exposed on the top rail of wall and tall units. Typical wall and base units with a center stile expose 1/2" of that stile.
(Base Cabinets): The door and drawer fronts overlay the frame, exposing 1/4" on the top and bottom rails and right and left stiles of base cabinets. Typical base units with a center stile expose 1/2" of that stile.
- **Full Overlay Doors:** The door and drawer fronts overlay the frame, exposing 1/4" on the top and bottom rails and right and left stiles of base cabinets. Typical base units with a center stile expose 1/2" of that stile.
- **Exceptions on Face Frame Reveals:** Oven units have 3" stiles and 9" intermediate rails (designed for universal flexibility of cut-out options) that create various reveals.
- Blind corner wall and base cabinets expose different center stiles reveals. Diagonal corners also vary.

CABINET DIMENSIONS

ROLL TRAY POSITIONS

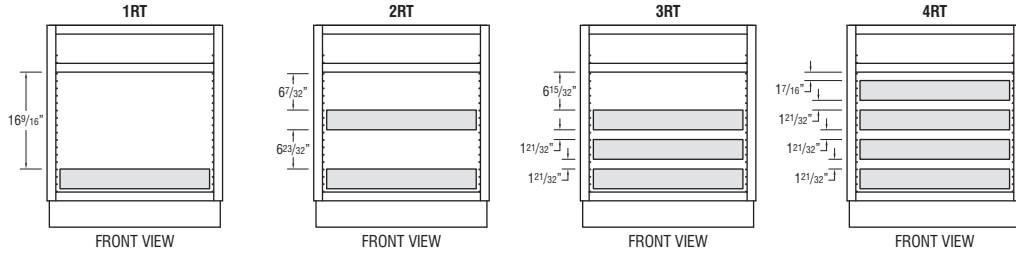

BASE CABINETS AND 34 1/2" HIGH VANITY CABINETS

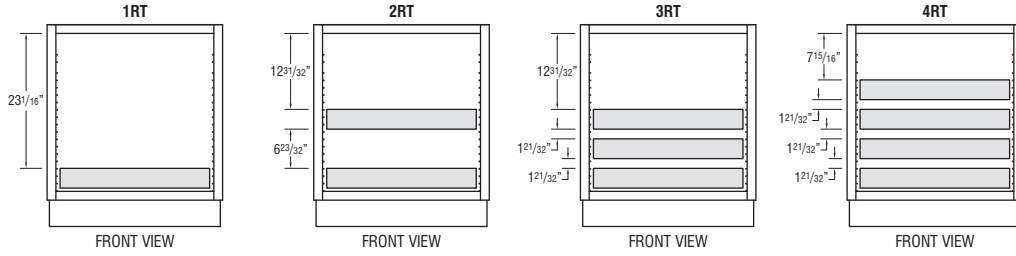

FULL HEIGHT BASE CABINETS

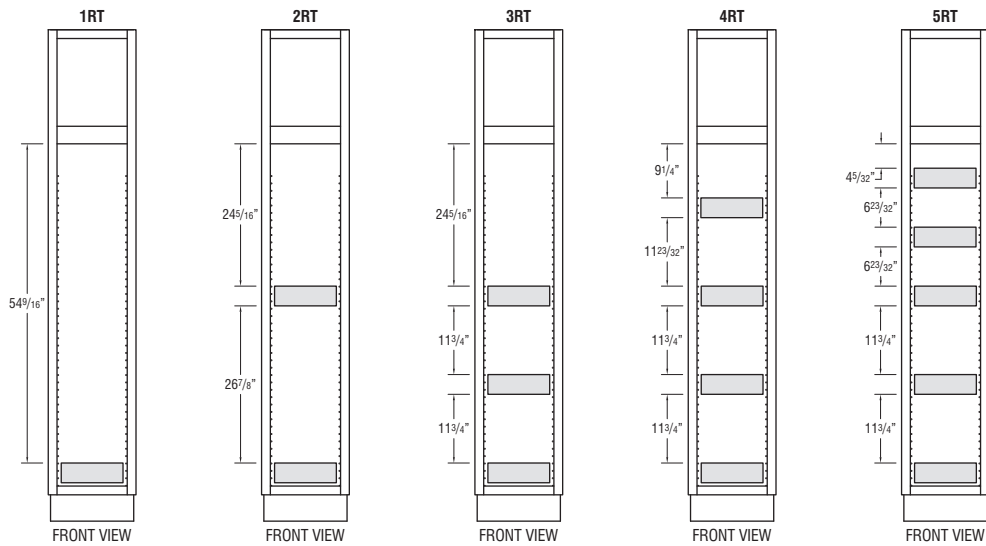

UTILITY CABINETS

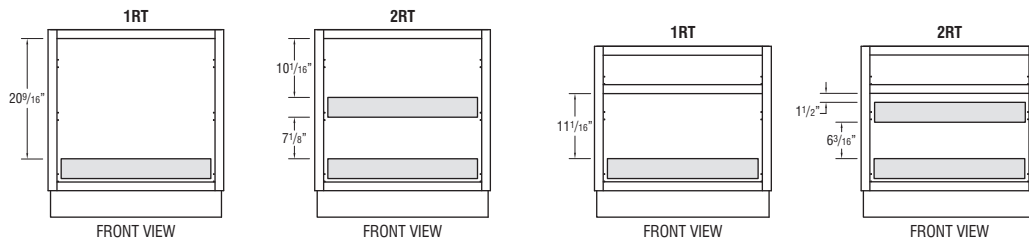

32" HIGH VANITY CABINETS

DESK DOOR DRAWER BASE CABINETS

CABINET DIMENSIONS

84" HIGH APPLICATION

Number after "W" Represents Height of Cabinet

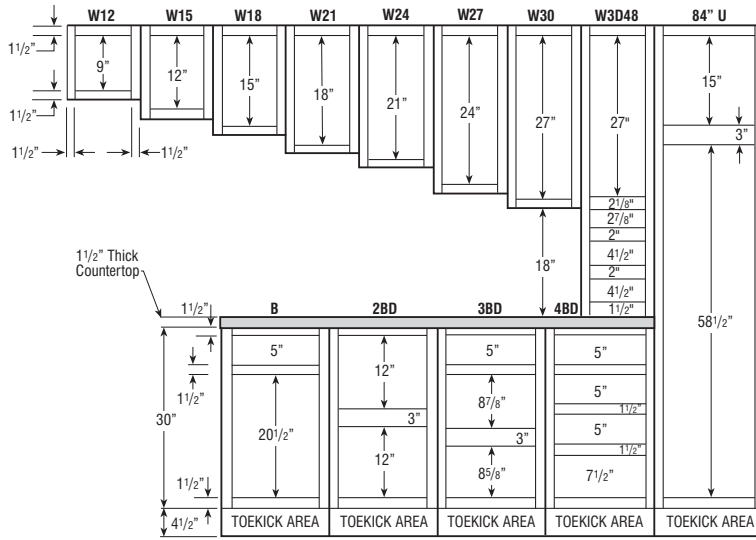

87" HIGH APPLICATION

Number after "W" Represents Height of Cabinet

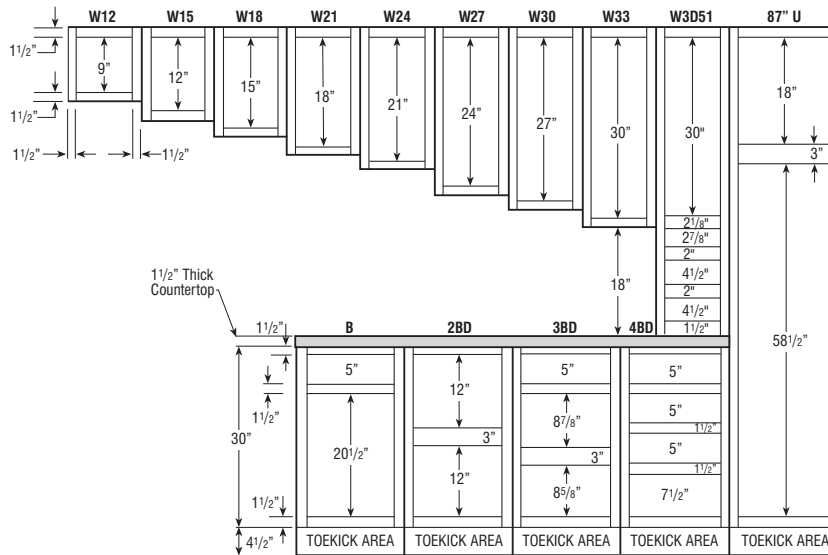

CABINET DIMENSIONS

90" HIGH APPLICATION

Number after "W" Represents Height of Cabinet

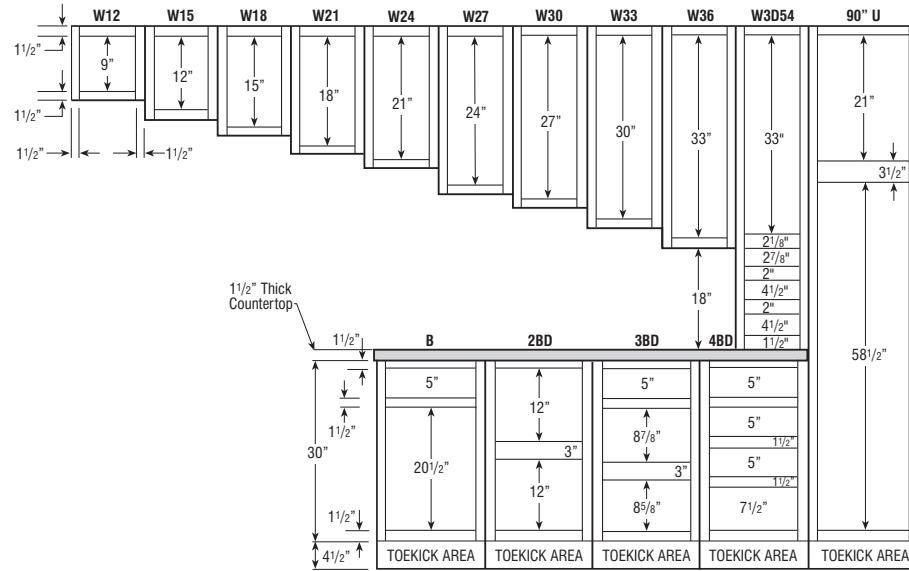

93" HIGH APPLICATION

Number after "W" Represents Height of Cabinet

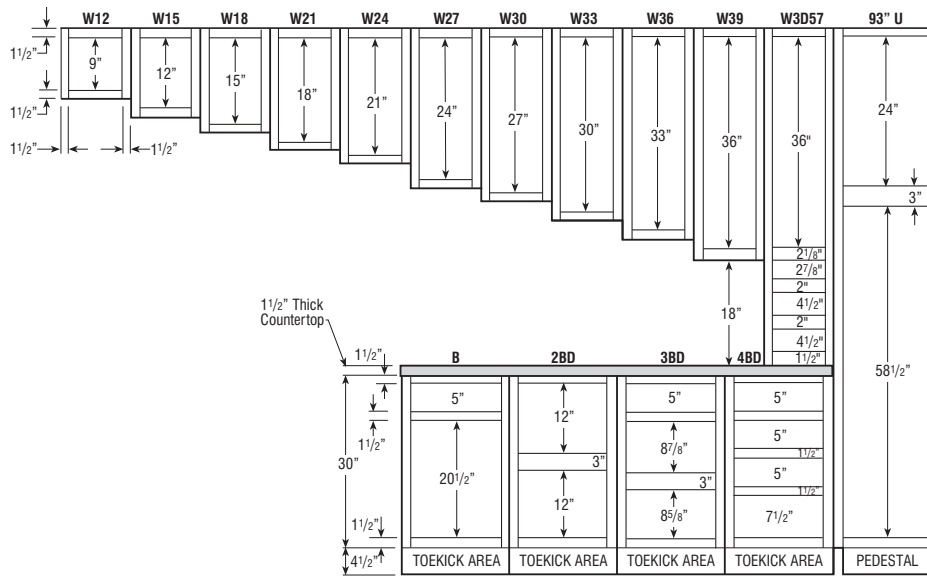

CABINET DIMENSIONS

96" HIGH APPLICATION

Number after "W" Represents Height of Cabinet

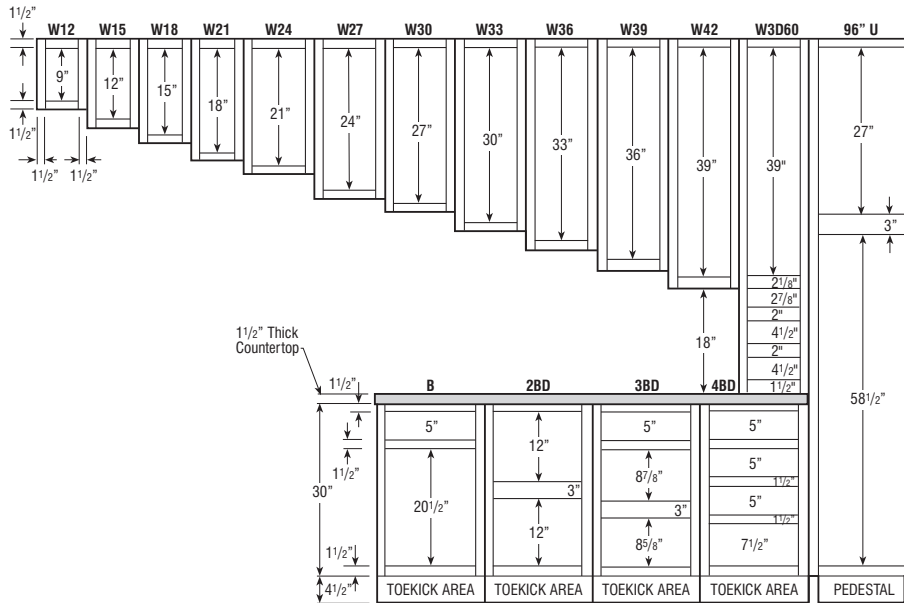

32 1/2" HIGH UNIVERSAL ACCESS CABINETS, 24" DEEP

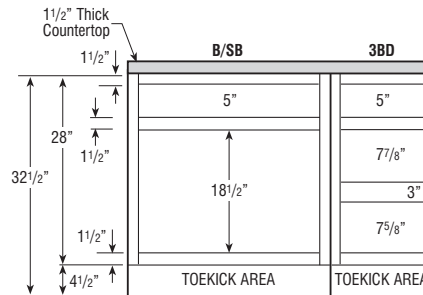

32" HIGH UNIVERSAL ACCESS CABINETS, 21" DEEP

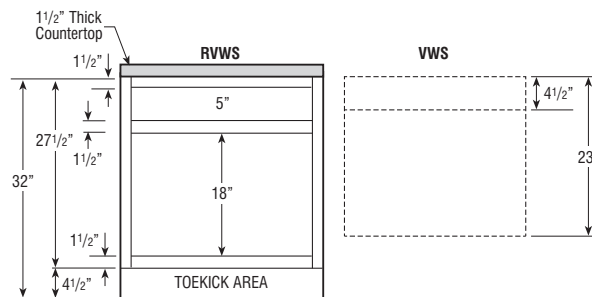

RVWS must be ordered with Vanity Wall Sink (VWS..23), not designed to be a stand-alone unit. See page 113 for more details.

CABINET DIMENSIONS

29" HIGH DESK CABINETS

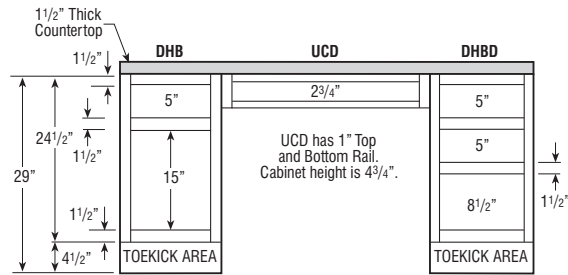

32" HIGH VANITY CABINETS

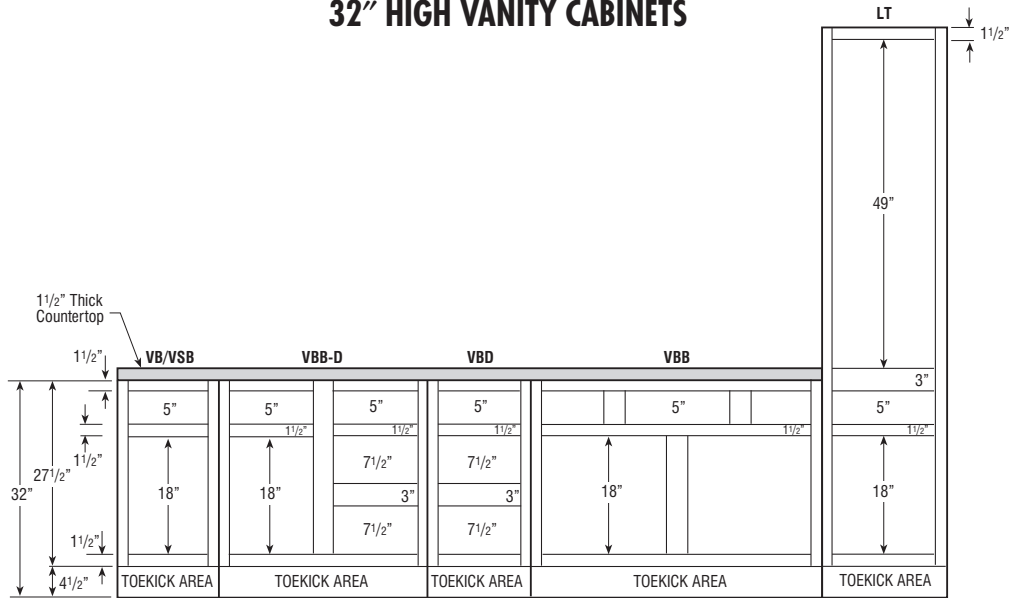

34 1/2" HIGH VANITY CABINETS

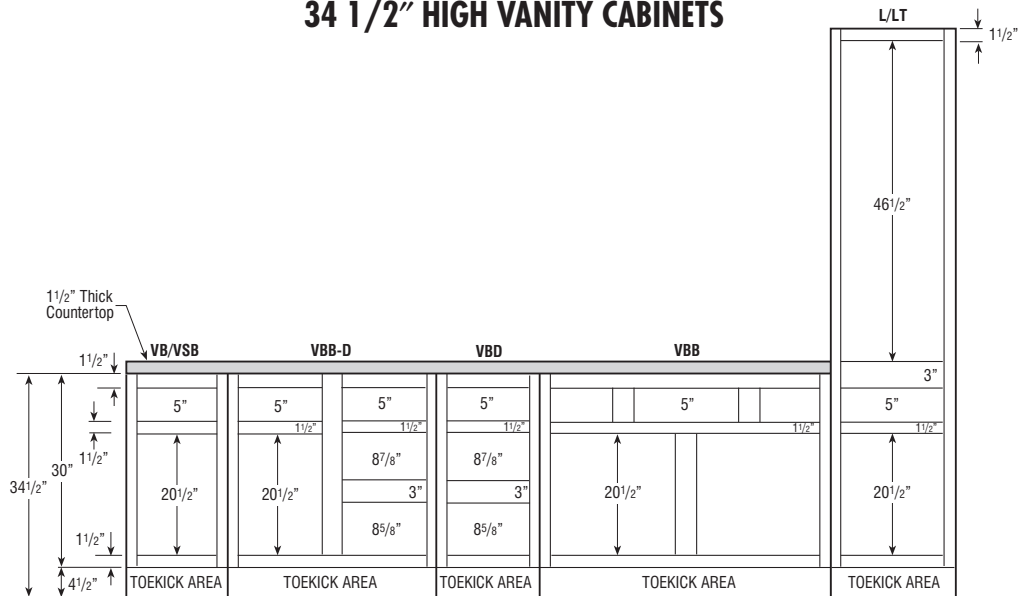

CABINET DIMENSIONS

DIMENSIONS FOR CORNER INSTALLATIONS (45° DIAGONAL)

12" DEEP CABINETS

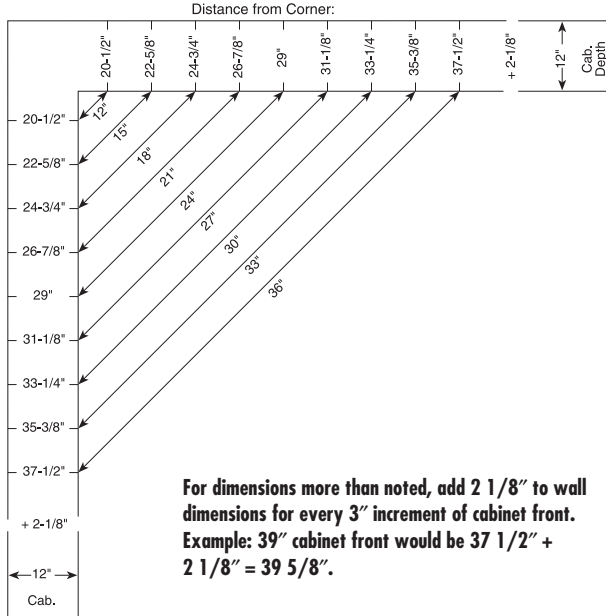

24" DEEP CABINETS

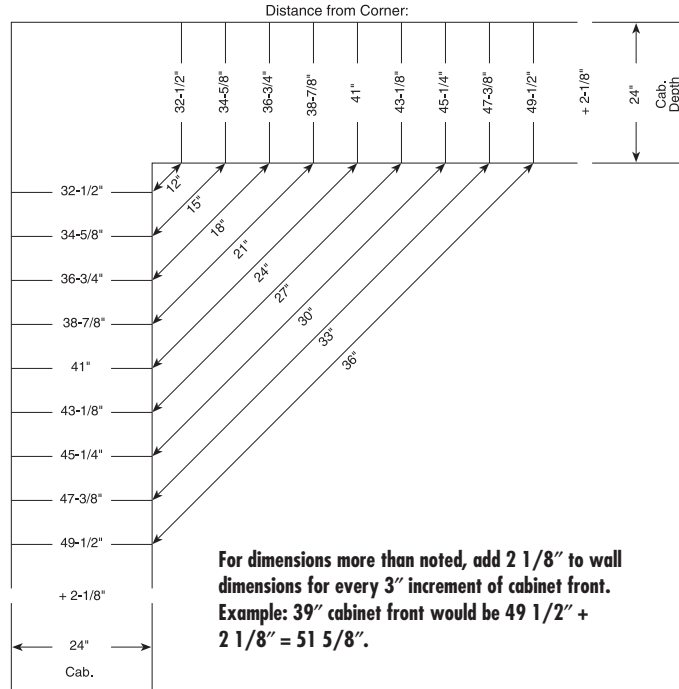

INSTALLATION HEIGHT REQUIREMENTS

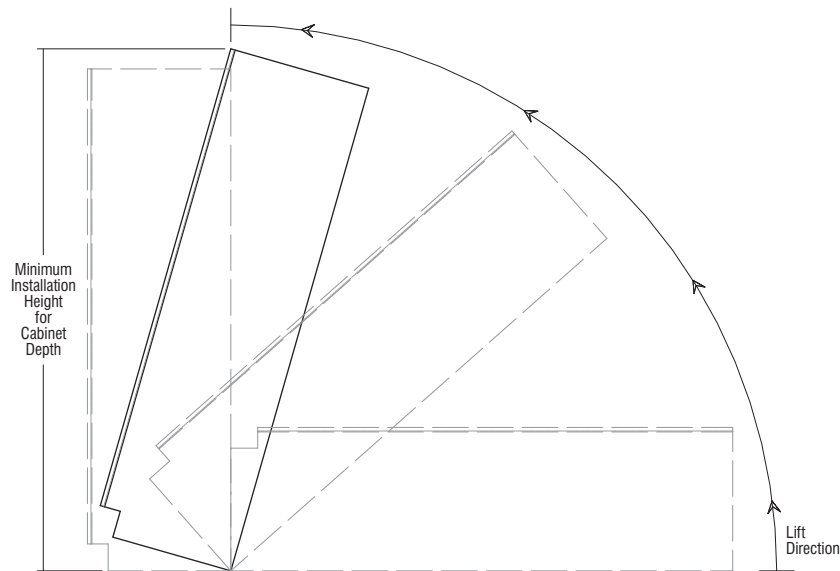

Height of ceiling needs to be considered for installation of tall cabinets. Cabinet height below includes toekick area:

Cabinet Height	Minimum Installation Height for Cabinet Depth				
	12"	15"	18"	21"	24"
84"	84 7/8"	85 11/32"	85 15/16"	86 19/32"	87 3/8"
87"	87 27/32"	88 5/16"	88 27/32"	89 1/2"	90 1/4"
90"	90 13/16"	91 1/4"	91 13/16"	92 7/16"	93 5/32"
93"*	89 5/16"	89 25/32"	90 5/16"	90 31/32"	91 23/32"
96"*	92 5/16"	92 3/4"	93 9/32"	93 29/32"	94 5/8"

*Separate pedestal base included with cabinet to be installed after cabinet is in an upright position.

HOMECAST CABINETS' DESIGN CHECKLIST

CONSTRUCTION OPTIONS

Cabinets with plywood ends (APU or PEU) are unfinished on the exterior; consider the following solutions for exposed exterior ends:

- Order finished ends (FB).
- Order Authentic Ends (AUTHB, AUTHL, AUTHR).
- Modify exposed cabinet ends to FPEB.
- Apply 1/4" veneer skin to hide 1/4" reveal. This will allow the ends to age uniformly with the rest of the kitchen and will make it flush.
- Apply decorative door kit (WDOF, BDOF, TDOP). This kit includes 1/4" veneer skin, decorative doors, and screws for field installation.

WOOD AND FINISH CHARACTERISTICS

Review specific details with the customer:

- Mineral Streaks, Birdseye Dots, Grain Variations, especially Hickory.
- Color Variations/Darkening.
- Finish Variations, hairline cracks may develop at frame joints on painted frame.
- Underside of cabinets are natural maple laminate. Use light rail or cabinet panel edge and skin to hide, especially when designing with peninsula wall cabinets.

ORGANIZATION

Review storage and usage needs with Customer.

- Cooking Solutions:
 - Wall Spice Rack Cabinet
- Storage Solutions:
 - SuperCabinet™
 - Pegged Dish Organizer
 - Wall Message Center
- Clean-up Center:
 - Base Wastebasket

CLEARANCES

- Add fillers between end cabinets and walls on full/modified full overlay door styles.
- Allow space between door/window trim and end cabinets for countertop and top moulding overhang.
- Include refrigerator door hinges in overall refrigerator height when placing cabinets above it.

Maintain a minimum clearance of 3" by pulling blind corners as follows:

- Full/Modified Full Overlay: 1 1/4", Traditional Overlay 1/2". (More is needed in certain situations such as when adjacent to an appliance or when using oversized pulls or knobs.)
- Allow sufficient clearance (3") on each side of accessory cabinets (such as roll-out trays, etc). Doors on these cabinets must open fully for accessories to be functional.
- Ensure the height between the cooktop and range hood is 24" to meet NKBA guidelines.

Qualify customer carefully on upper cabinet/microwave advantages/disadvantages as follows:

- Minimum of 18" from cooktop to upper cabinet/above the range microwave which allows for easy access to either, but less room over back burner.
- Minimum of 21" from cooktop to upper cabinet/microwave which allows for access to large pots on back burner of cooktop, but longer reach to microwave.

FILLERS

- Place fillers toward end of run where least conspicuous if needed.
- Attach overlay fillers on top of the base, wall, or tall fillers when using full overlay door styles to maintain a consistent reveal. Don't forget to include blind corner fillers.
- Add a filler at least 6" wide to accommodate a decorative onlay when the filler is used as valance.

VARYING HEIGHTS AND DEPTHS

- Increase the depth of a wall cabinet run when you increase the height (so moulding on adjacent cabinet will kill into the side of the taller cabinet).
- Skin the sides of tall cabinets to 1) hide the seam between the toekick pedestal and the cabinet, 2) keep adjacent base and wall cabinets out from reveal of tall cabinet.
- Add increased depth on tall end panels for a built-in look for deep refrigerators.
- Account for the additional support needed for wall cabinets with a depth of 18" or greater. This can be achieved by installing end panels.

MATCHING INTERIOR CABINETS/GLASS OPTIONS

- Verify cut-for-glass or mullion door option is available on desired cabinet size. (See pages 35-36 for available cut-for-glass/mullion door sizes.)
- Verify glass insert option is available for desired cut-for-glass door size chosen.
- Verify matching interior option has been selected for all open or glass cabinets.
- Verify mullion door lite grid matches customer expectations.

MOULDINGS

- Verify correct amount of crown moulding has been ordered.
- Order toekick caps.
- Order extra scribe.

ISLANDS AND PENINSULAS

- Consider standard height bars are 34 1/2" tall and require 19" knee space. Raised bars are 42" tall.
- Consider base peninsula cabinets (P) are 24 1/4" deep and require 12" of knee space. Use back panels/doors to flush non-P cabinets with P cabinets.
- Use outside corner moulding if a skin is exposed on the back of the island.

APPLIANCES

- Note for all consumers, appliances are not included with any cabinetry product.
- Do not place dishwashers next to diagonal front cabinet (interference) or next to a range (no countertop support).
- Verify refrigerator door has enough clearance to open beyond 90 degrees so refrigerator drawers can be utilized. Refer to appliance manufacturer's specs.
- Add TF696FH, as it may be required to frame around built-in microwave ovens and other built-in items. Refer to appliance manufacturer's specs.
- Order appliance panels.

MISCELLANEOUS

- Order full size touch-up kit.

kitchen planning guidelines

DOOR/ENTRY

- Door opening should be at least 32" wide, requiring a minimum 2' 10" wide door.

DOOR INTERFERENCE

- Entry door should not interfere with safe appliance operation or appliance doors.

DISTANCE BETWEEN WORK CENTERS

- With three work centers, the total distance traveled should not be more than 26' with no single leg of the triangle less than 4' or more than 9'.
- With more than three work centers, each additional travel distance to another work center should be no less than 4' or more than 9'. Each leg is measured from the center-front of the appliance/sink. No work triangle leg should intersect an island/peninsula by more than 12".

SEPARATING WORK CENTERS

- A tall obstacle should not separate two primary work centers. A properly recessed tall corner unit is acceptable.

WORK TRIANGLE TRAFFIC

- Major traffic patterns should not cross through the basic work triangle.

WORK AISLE

- The work aisle should be at least 42" for one cook and at least 48" for multiple cooks.

WALKWAY

- The walkway width should be at least 36".

TRAFFIC CLEARANCE AT SEATING

- Allow 32" of clearance from the table to wall/obstacle if no traffic passes behind a seated diner. If traffic passes behind the diner, allow at least 36" to edge past or 44" to walk past.

SEATING CLEARANCE

- 30" high tables/counters should allow a 24" wide by 18" deep space for each seated diner and at least 18" knee space.
- 36" high counters should allow a 24" wide by 15" deep space for each seated diner and at least 15" knee space.
- 42" high counters should allow a 24" wide by 12" deep space for each seated diner and at least 12" knee space.

CLEAN-UP/PREP SINK PLACEMENT

- With only one sink, locate it adjacent to or across from the cooking surface and refrigerator.

CLEAN-UP/PREP SINK LANDING AREA

- Include at least a 24" wide landing space on one side of the sink and 18" on the other.
- If all the countertop at the sink is not the same height, plan a 24" landing space on one side of the sink and 3" of countertop frontage on the other, both at the same height of the sink.

PREPARATION/WORK AREA

- Include a section of countertop at least 36" wide x 24" deep next to the sink for a work area.

DISHWASHER PLACEMENT

- Nearest edge of dishwasher should be within 36" of nearest edge of sink. Provide at least 21" of standing space between the edge of the dishwasher and countertop frontage/appliances/cabinets which are placed at a right angle to the dishwasher.

WASTE RECEPTACLES

- Include at least 2 waste receptacles, one near the sink and the other nearby for recycling.

AUXILIARY SINK

- Provide at least 3" of countertop frontage on one side of the auxiliary sink and 18" on the other side, both at the same height as the sink.

REFRIGERATOR LANDING AREA

- Include at least 15" of landing area on the handle side of the refrigerator, 15" on either side of a side-by-side refrigerator, 15" of landing space which is no more than 48" across from the front of the refrigerator, and 15" above or adjacent to any under-counter style refrigerator.

COOKING SURFACE LANDING AREA

- Include a minimum of 12" of landing area on one side of the cooking surface and 15" on the other.
- If cooking surface is at a different countertop height than the rest of the kitchen, then the 12" and 15" landing areas must be the same height as the cooking surface.
- For safety reasons, in an island or peninsula situation, the countertop should extend a minimum of 9" behind the cooking surface if the counter height is the same height as the cooking surface.

COOKING SURFACE CLEARANCE

- Allow 24" between the cooking surface and a protected noncombustible surface above it.
- At least 30" of clearance is required between the cooking surface and an unprotected/combustible surface above it.
- If a microwave/hood combination is used, then the manufacturer's specifications should be followed.

COOKING SURFACE VENTILATION

- A correctly sized, ducted ventilation system is recommended for all cooking surface appliances. The recommended minimum is 150 CFM.
- Code requires that the manufacturer's specifications be followed. Minimum exhaust rate for a ducted hood is 100 CFM and must be ducted to the outside.
- Make-up air may need to be provided. Refer to local codes.

COOKING SURFACE SAFETY

- Do not locate cooking surface under an operable window.
- Window treatments above cooking surface should not use flammable materials.
- Place a fire extinguisher near the kitchen exit away from cooking equipment.

MICROWAVE OVEN PLACEMENT

- The ideal location for the bottom of the microwave is 3" below the principle user's shoulder, but no more than 54" above the floor.

MICROWAVE LANDING AREA

- Provide at least 15" above, below, or adjacent to the handle side of a microwave oven.

OVEN LANDING AREA

- Include at least 15" next to or above the oven.
- A 15" landing area that is not more than 48" away is also acceptable as long as the oven does not open into a walkway.

COMBINING LANDING AREAS

- If two landing areas are adjacent to one another, determine a new minimum for the two by taking the longer of the two and adding 12".

continued

kitchen planning guidelines (continued)

COUNTERTOP SPACE

- A total of 158" of countertop frontage, 24" deep, with at least 15" clearance above is needed to accommodate all landing, preparation, work, and storage areas.

COUNTERTOP EDGES

- Clipped or round corners, rather than sharp edges, are recommended on all counters.

STORAGE

- The recommended total shelf/drawer frontage for a small kitchen (less than 150 square feet) is 1400", for a medium kitchen (151 to 350 square feet) is 1700", and for a large kitchen (greater than 350 square feet) is 2000".

Sizes:	S	M	L
Wall	300"	360"	360"
Base	520"	615"	660"
Drawer	360"	400"	525"
Pantry	180"	230"	310"
Misc.	40"	95"	145"

- The totals for wall, base, drawer, and pantry shelf/drawer frontage can be adjusted upward or downward as long as the recommended total stays the same.

STORAGE AT CLEAN-UP/PREP SINK

- The recommended total for a small kitchen is 400", a medium kitchen is 480", a large kitchen is 560", and should be located within 72" of the centerline of the main clean-up/prep sink.

CORNER CABINET STORAGE

- At least one corner cabinet should include a functional storage device.

ELECTRICAL RECEPTACLES

- GFCI (Ground-Fault-Circuit-Interrupter) protection is required on all receptacles servicing countertop surfaces within the kitchen.

LIGHTING

- Every work surface should be well illuminated. At least one wall switch-controlled light must be placed at the entrance.
- Window/skylight area, equal to at least 8% of the total square footage of the kitchen, or a total living space which includes a kitchen, is required.

bathroom planning guidelines

DOOR/ENTRY

- Doorway opening should be at least 32", requiring a minimum 2' 10" wide door.

DOOR INTERFERENCE

- The door area should include clear floor space for maneuvering which varies according to the type of door and the direction of the approach.

CEILING HEIGHT

- Bathroom floor to ceiling minimum height is 80". A shower or tub with a shower head shall have a minimum floor to ceiling height of 80" above a minimum area 30" x 30" at the shower head.

CLEAR SPACE

- Plan a clear space of 30" from the front edge of all fixtures to any opposite bath fixture, wall, or obstacle.
- A minimum space of at least 21" is required in front of a lavatory, toilet, bidet, and tub, with a 24" minimum space in front of a shower entry.

SINGLE LAVATORY PLACEMENT

- The distance from the centerline of the lavatory to the sidewall/tall obstacle should be at least 20".
- The minimum distance required is 15". The minimum distance required between a wall and the edge of a lavatory is 4".

DOUBLE LAVATORY PLACEMENT

- The distance between the centerlines of two lavatories should be at least 36".
- The minimum distance required is 30".
- The minimum distance required between the edges of two lavatories is 4".

LAVATORY/VANITY HEIGHT

- The height for a lavatory varies from 32" to 43" to fit the user.

COUNTERTOP EDGES

- Clipped or round corners, rather than sharp edges, are recommended on all counters.

SHOWER SIZE

- The interior shower size should be at least 36" x 36". The minimum interior shower size required is 30" x 30".

STORAGE

- Provide adequate, accessible storage for toiletries, bath linens, grooming and general bathroom supplies.
- Storage of frequently used items should be 15" to 48" above floor.

ELECTRICAL RECEPTACLES

- All GFCI receptacles should be located at electrical appliance points of use.

Load bearing floors and shelves can support 15 lbs. per square foot. Warranty does not cover overloading beyond this point.

To view a complete and updated list of the NKBA Guidelines, visit <https://nkba.org/info/guidelines>

© Copyright 2007 National Kitchen & Bath Association

WALL CABINET NOMENCLATURE

All Wall Cabinets are 12" deep unless otherwise noted.

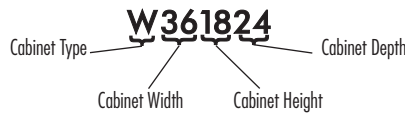

MODIFICATIONS GRID KEY

- Available
- STD Standard on these cabinets

MODIFICATIONS			
Mod.	Description	Mod.	Description
ADDTK	Add Toekick	FPEB	Furniture Finished Plywood End Panels
AUTHB	Authentic Ends Both	FTK	Flush Toekick
AUTHL	Authentic End Left	FTKAV	Flush Toekick Arch
AUTHR	Authentic End Right	FTKAV	Flush Toekick Arch
CBO	Cabinet Box Only	FTKAV	Flush Toekick Arch
CCO	Cabinet Case Only	FTKAV	Flush Toekick Arch
CFNTO	Cabinet Front Only	FULL	Full Overlay
CFRMO	Cabinet Frame Only	ID	Increased Depth
CND	Cabinet with No Door, with Drawer	MFO	Modified Full Overlay
EXL	Extended Stile Left	MI	Matching Interior
EXR	Extended Stile Right	NSCH	Non SoftTouch Hinge
FB	Finished Ends	P	Peninsula
FDRW	Furniture Board Drawer	RD	Reduced Depth
		RECTKL	Recessed Toekick Left
		RECTKR	Recessed Toekick Right

CONSTRUCTION UPGRADES	
Mod.	Description
APU	All-plywood Unfinished
PEU	Plywood Ends Unfinished

DECORATIVE DOOR OPTIONS	
Mod.	Description
CG	Cut-for-glass Doors
MD	Mullion Doors

Wall Single Door, 12" High	Price Point	1	2	3	4	5	6	7	8
		W1212 L or R	234	279	293	312	346	351	360
		W1512 L or R	246	295	311	329	366	372	421
		W1812 L or R	261	313	328	348	388	393	447
		W2112 L or R	275	329	345	366	408	413	470
		W2412 L or R	289	346	363	385	429	434	494

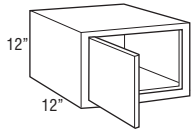

Modifications

ADDTK	AUTH	CBO	CCO	CFNTO	CFRMO	CND	EX	FB	FDRW	FPEB	FTK	FTK_V	FULL/MFO	ID	MI	NSCH	P	RD	RECTKL/R
•*	•	•	•	•	•	•	•	•	•	•	•*	•*	•	•	•	•	•	•	•*

*ADDTK, FTK, and RECTKL/RECTKR not available on W2112 and W2412. *FTKAV/FTKAV not available on W1212, W2112, and W2412.

Construction Upgrades

APU	PEU
•	•

Decorative Door Options

CG	MD
•	•

Wall Double Door, 12" High	1	2	3	4	5	6	7	8
W2412B	291	347	365	388	430	437	449	495
W2712B	307	366	386	407	454	462	473	523
W3012B	311	371	390	414	459	466	478	529
W3312B	329	395	416	440	482	489	510	548
W3612B	345	415	433	461	491	498	530	562
W3712B	355	426	447	475	499	506	540	572
W3912	365	436	459	489	506	513	551	582
W4212	383	458	482	513	531	539	579	611
W4512	402	481	506	539	558	566	608	642
W4812	474	568	597	636	658	668	717	758

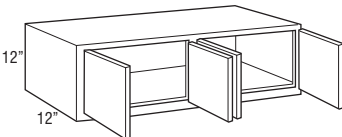
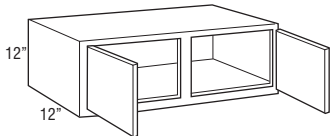
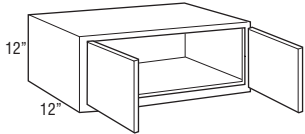

Modifications

ADDTK	AUTH	CBO	CCO	CFNTO	CFRMO	CND	EX	FB	FDRW	FPEB	FTK	FTK_V	FULL/MFO	ID	MI	NSCH	P	RD	RECTKL/R
•	•	•	•	•	•	•	•	•	•	•	•	•*	•	•	•	•	•	•	•

*FTKAV/FTKAV not available on W3712B.

Construction Upgrades

APU	PEU
•	•

Decorative Door Options

CG	MD
•	•

Wall Top Hinge Single Door, 12" High

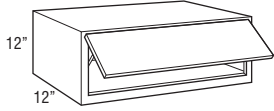

	1	2	3	4	5	6	7	8
WTH3012	588	648	667	690	736	743	755	806
WTH3612	652	722	741	769	799	806	838	870

- Utilizes doors from 30" and 36" high wall cabinets. Grain on center panels will run horizontally and door rail configuration on non-miter doors will be unique from adjacent cabinet doors. See page 8 for more details.
- Cabinet may utilize one or two lift mechanisms depending on door size and weight. Door lift mechanism tension can be field adjusted.
- Depth can be reduced to a minimum of 9".
- Door will open a maximum of 105° due to hinges. For applications close to a ceiling, door angle can be restricted to 86° with a Hinge Angle Restriction Clip (INTGHRSTRCLIP, see page 177).
- Lift mechanisms and mounting brackets will be visible if used with transparent textured glass panels.

Modifications

ADDTK	AUTH	CBO	CCO	CFNTO	CFRMO	CND	EX	FB	FDRW	FPEB	FTK	FTK_V	FULL/MFO	ID	MI	NSCH	P	RD	RECTKL/R
	•		•											•	•				•

Construction Upgrades

APU	PEU
•	•

Decorative Door Options

CG	MD
•	

Wall Double Door, 12" High, 24" Deep

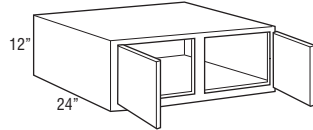
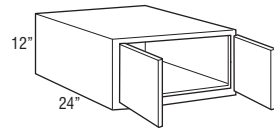

W301224B	376	451	473	501	507	513	559	592
W331224B	396	475	498	527	534	540	588	623
W361224B	415	497	522	555	559	566	611	644
W371224B	429	512	538	564	569	576	616	649

W391224	442	527	554	572	578	587	620	653
---------	-----	-----	-----	-----	-----	-----	-----	-----

- 24" deep cabinets must be fully supported by screws installed in a structural member in the ceiling or soffit, and into adjacent cabinets or tall panels.
- Load limit is 15 lbs. per square foot of load bearing surface.

Modifications

ADDTK	AUTH	CBO	CCO	CFNTO	CFRMO	CND	EX	FB	FDRW	FPEB	FTK	FTK_V	FULL/MFO	ID	MI	NSCH	P	RD	RECTKL/R
•	•		•										•*		•	•			•

*FTKAV/FTKRV not available on W371224B.

Construction Upgrades

APU	PEU
•	•

Decorative Door Options

CG	MD
•	

Wall Single Door, 15" High

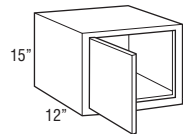

W1215 L or R	240	291	305	323	363	370	385	414
W1515 L or R	255	308	323	343	386	391	406	437
W1815 L or R	269	325	343	362	407	415	431	463
W2115 L or R	283	342	361	381	428	436	453	487
W2415 L or R	298	360	380	401	450	458	476	512

Modifications

ADDTK	AUTH	CBO	CCO	CFNTO	CFRMO	CND	EX	FB	FDRW	FPEB	FTK	FTK_V	FULL/MFO	ID	MI	NSCH	P	RD	RECTKL/R
•*	•		•												•	•			•*

*ADDTK, FTK, and RECTKL/RECTKR not available on W2115 and W2415. *FTKAV/FTKRV not available on W1215, W2115, and W2415.

Construction Upgrades

APU	PEU
•	•

Decorative Door Options

CG	MD
•	•†

†MD not available on W1215.

Wall Double Door, 15" High

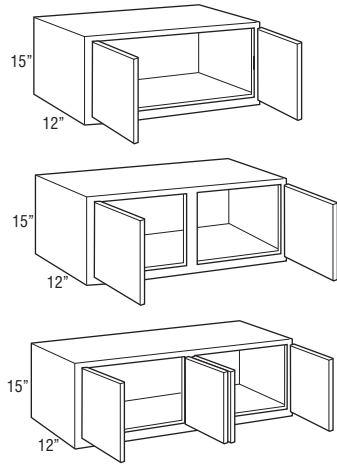

	1	2	3	4	5	6	7	8
W2415B	299	362	382	402	453	461	480	515
W2715B	316	383	403	425	478	488	506	543
W3015B	318	387	406	429	483	492	510	549
W3315B	335	404	425	452	511	521	551	580
W3615B	357	425	447	470	542	554	577	623
W3715B	365	438	461	486	551	560	590	628
W3915	372	451	474	500	558	566	601	633
W4215CS	382	463	486	513	572	580	616	649
W4215	391	474	498	525	586	594	631	665
W4515	411	498	523	551	615	624	663	698
W4815	485	588	617	650	726	736	782	824

Modifications

ADDTK	AUTH	CBO	CCO	CFNTO	CFRMO	CND	EX	FB	FDRW	FPEB	FTK	FTK_V	FULL/MFO	ID	MI	NSCH	P	RD	RECTKL/R
•*	•	•	•	•	•	•	•	•	•	•	•*	•*	•	•	•	•	•	•	•*

*ADDTK, FTK, and RECTKL/RECTKR not available on W4215CS. *FTKAV/FTKAV not available on W3715B and W4215CS.

Construction Upgrades

APU	PEU
•	•

Decorative Door Options

CG	MD
•	•†

†MD not available on W3715B, W3915, W4215, and W4515.

Wall Top Hinge Single Door, 15" High

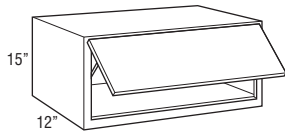

WTH3015	613	682	702	724	778	787	806	845
WTH3615	691	759	781	805	877	888	912	957

- Utilizes doors from 30" and 36" high wall cabinets. Grain on center panels will run horizontally and door rail configuration on non-miter doors will be unique from adjacent cabinet doors. See page 8 for more details.
- Cabinet may utilize one or two lift mechanisms depending on door size and weight. Door lift mechanism tension can be field adjusted.
- Depth can be reduced to a minimum of 9".
- Door will open a maximum of 105° due to hinges. For applications close to a ceiling, door angle can be restricted to 86° with a Hinge Angle Restriction Clip (INTGHRSTRCLIP, see page 177).
- Lift mechanisms and mounting brackets will be visible if used with transparent textured glass panels.

Modifications

ADDTK	AUTH	CBO	CCO	CFNTO	CFRMO	CND	EX	FB	FDRW	FPEB	FTK	FTK_V	FULL/MFO	ID	MI	NSCH	P	RD	RECTKL/R
•	•	•	•	•	•	•	•	•	•	•	•	•	•	•	•	•	•	•	•

Construction Upgrades

APU	PEU
•	•

Decorative Door Options

CG	MD
•	•

Wall Double Door, 15" High, 24" Deep

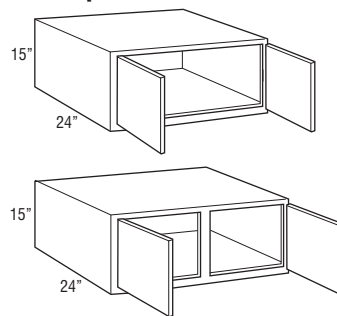

W301524B	381	460	485	510	558	563	591	633
W331524B	401	484	510	537	587	593	622	666
W361524B	424	508	534	565	601	611	652	687
W371524B	437	522	547	580	618	629	657	696
W391524	450	535	561	596	636	645	660	704

- 24" deep cabinets must be fully supported by screws installed in a structural member in the ceiling or soffit, and into adjacent cabinets or tall panels.
- Load limit is 15 lbs. per square foot of load bearing surface.

Modifications

ADDTK	AUTH	CBO	CCO	CFNTO	CFRMO	CND	EX	FB	FDRW	FPEB	FTK	FTK_V	FULL/MFO	ID	MI	NSCH	P	RD	RECTKL/R
•	•	•	•	•	•	•	•	•	•	•	•	•*	•	•	•	•	•	•	•

*FTKAV/FTKAV not available on W371524B.

Construction Upgrades

APU	PEU
•	•

Decorative Door Options

CG	MD
•	•†

†MD not available on W371524B and W391524.

Wall Single Door, 18" High

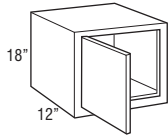

	1	2	3	4	5	6	7	8
W1218 L or R	257	300	316	334	362	369	387	413
W1518 L or R	273	318	333	354	385	390	409	435
W1818 L or R	288	338	354	375	406	414	433	461
W2118 L or R	299	350	367	389	422	429	450	478
W2418 L or R	311	362	380	403	437	445	465	495

Modifications

ADDTK	AUTH	CBO	CCO	CFNTO	CFRMO	CND	EX	FB	FDRW	FPEB	FTK	FTK_V	FULL/MFO	ID	MI	NSCH	P	RD	RECTKL/R
•	•	•	•	•	•	•	•	•	•	•	•*	•	•	•	•	•	•	•	•

*FTKAV/FTKRV not available on W1218.

Construction Upgrades

APU	PEU
•	•

Decorative Door Options

CG	MD
•	•†

†MD not available on W1218.

Wall Double Door, 18" High

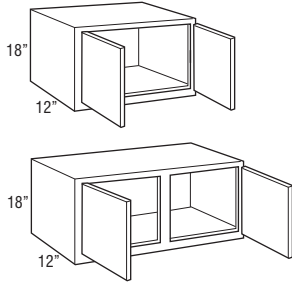

W2418B	325	383	402	426	461	467	490	523
W2718B	356	420	440	463	513	521	556	598
W3018B	359	424	446	467	520	527	561	603
W3318B	374	440	461	489	547	557	590	633
W3618B	385	452	475	506	576	584	616	655
W3718B	387	454	477	508	577	586	618	660
W3918	388	456	478	509	577	586	620	664
W4218	395	470	494	520	608	617	651	697
W4518	415	494	519	546	638	648	684	732
W4818	490	583	612	644	753	765	807	864

Modifications

ADDTK	AUTH	CBO	CCO	CFNTO	CFRMO	CND	EX	FB	FDRW	FPEB	FTK	FTK_V	FULL/MFO	ID	MI	NSCH	P	RD	RECTKL/R
•	•	•	•	•	•	•	•	•	•	•	•*	•	•	•	•	•	•	•	•

*FTKAV/FTKRV not available on W3718B.

Construction Upgrades

APU	PEU
•	•

Decorative Door Options

CG	MD
•	•

Wall Top Hinge Single Door, 18" High

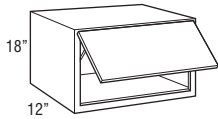

WTH3018	684	749	771	792	845	852	886	928
WTH3618	742	809	832	863	933	942	973	1013

- Utilizes doors from 30" and 36" high wall cabinets. Grain on center panels will run horizontally and door rail configuration on non-miter doors will be unique from adjacent cabinet doors. See page 8 for more details.
- Cabinet may utilize one or two lift mechanisms depending on door size and weight. Door lift mechanism tension can be field adjusted.
- Depth can be reduced to a minimum of 9".
- Door will open a maximum of 105° due to hinges. For applications close to a ceiling, door angle can be restricted to 86° with a Hinge Angle Restriction Clip (INTGHRSTRCLIP, see page 177).
- Lift mechanisms and mounting brackets will be visible if used with transparent textured glass panels.

Modifications

ADDTK	AUTH	CBO	CCO	CFNTO	CFRMO	CND	EX	FB	FDRW	FPEB	FTK	FTK_V	FULL/MFO	ID	MI	NSCH	P	RD	RECTKL/R
•	•	•	•	•	•	•	•	•	•	•	•	•	•	•	•	•	•	•	•

Construction Upgrades

APU	PEU
•	•

Decorative Door Options

CG	MD
•	•

Wall Double Door, 18" High, 24" Deep

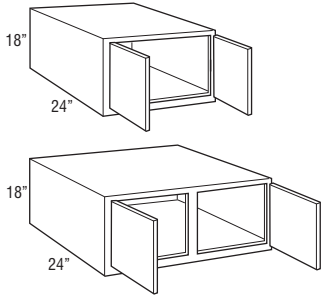

	1	2	3	4	5	6	7	8
W301824B	410	489	514	548	600	611	646	694
W331824B	432	515	541	577	632	643	680	731
W361824B	464	542	570	605	660	671	711	756
W371824B	470	554	581	615	669	680	716	762

W391824	476	565	593	626	678	689	721	768
----------------	-----	-----	-----	-----	-----	-----	-----	-----

- 24" deep cabinets must be fully supported by screws installed in a structural member in the ceiling or soffit, and into adjacent cabinets or tall panels.
- Load limit is 15 lbs. per square foot of load bearing surface.

Modifications

ADDTK	AUTH	CBO	CCO	CFNT0	CFRMO	CND	EX	FB	FDRW	FPEB	FTK	FTK_V	FULL/MFO	ID	MI	NSCH	P	RD	RECTKL/R
•	•	•	•	•	•	•	•	•	•	•	•	•*	•	•	•	•	•	•	•

*FTKAV/FTKFV not available on W371824B.

Construction Upgrades

APU	PEU
•	•

Decorative Door Options

CG	MD
•	• [†]

[†]MD not available on W371824B and W391824.

Wall Single Door, 21" High

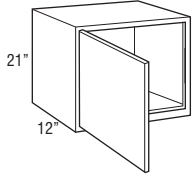

W1221 L or R	297	354	372	395	436	443	469	500
W1521 L or R	315	375	393	418	462	469	497	530
W1821 L or R	332	396	417	442	489	495	526	561
W2121 L or R	351	420	440	467	517	524	556	593
W2421 L or R	360	431	452	480	530	538	571	609

Modifications

ADDTK	AUTH	CBO	CCO	CFNT0	CFRMO	CND	EX	FB	FDRW	FPEB	FTK	FTK_V	FULL/MFO	ID	MI	NSCH	P	RD	RECTKL/R
•	•	•	•	•	•	•	•	•	•	•	•	•*	•	•	•	•	•	•	•

*FTKAV/FTKFV not available on W1221.

Construction Upgrades

APU	PEU
•	•

Decorative Door Options

CG	MD
•	

Wall Double Door, 21" High

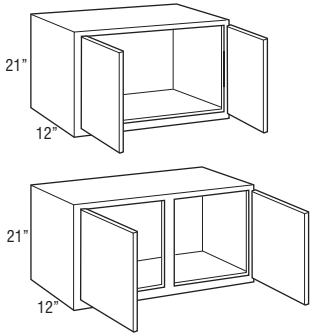

W2421B	369	442	463	492	543	552	586	625
W2721B	390	466	490	519	573	582	617	659
W3021B	394	472	494	524	579	589	623	666
W3321B	407	491	513	542	601	611	658	699
W3621B	429	512	539	571	636	645	694	732
W3721B	432	518	544	575	641	649	699	737

W3921	434	522	548	579	645	653	704	742
W4221	456	548	575	608	677	686	739	779
W4521	479	575	604	638	711	720	776	818
W4821	565	679	713	753	839	850	916	965

Modifications

ADDTK	AUTH	CBO	CCO	CFNT0	CFRMO	CND	EX	FB	FDRW	FPEB	FTK	FTK_V	FULL/MFO	ID	MI	NSCH	P	RD	RECTKL/R
•	•	•	•	•	•	•	•	•	•	•	•	•*	•	•	•	•	•	•	•

*FTKAV/FTKFV not available on W3721B.

Construction Upgrades

APU	PEU
•	•

Decorative Door Options

CG	MD
•	

Wall Top Hinge Single Door, 21" High

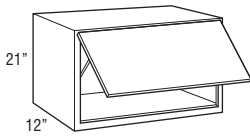

WTH3021	755	833	855	885	941	950	984	1027
WTH3621	831	915	942	973	1038	1048	1096	1134

- Utilizes doors from 30" and 36" high wall cabinets. Grain on center panels will run horizontally and door rail configuration on non-miter doors will be unique from adjacent cabinet doors. See page 8 for more details.
- Cabinet may utilize one or two lift mechanisms depending on door size and weight. Door lift mechanism tension can be field adjusted.
- Depth can be reduced to a minimum of 9".
- Door will open a maximum of 105° due to hinges. For applications close to a ceiling, door angle can be restricted to 86° with a Hinge Angle Restriction Clip (INTGHRSTRCLIP, see page 177).
- Lift mechanisms and mounting brackets will be visible if used with transparent textured glass panels.

Modifications

ADDTK	AUTH	CBO	CCO	CFNTO	CFRMO	CND	EX	FB	FDRW	FPEB	FTK	FTK_V	FULL/MFO	ID	MI	NSCH	P	RD	RECTKL/R
	•		•				•	•		•			•	•	•			•	

Construction Upgrades

APU	PEU
•	•

Decorative Door Options

CG	MD
•	

Wall Double Door, 21" High, 24" Deep

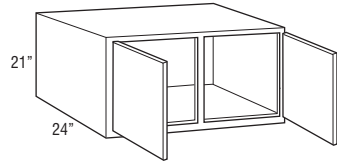
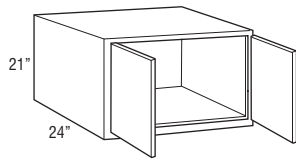

W302124B	438	524	549	582	643	654	692	740
W332124B	460	551	578	611	674	681	741	790
W362124B	501	587	615	648	710	724	773	821
W372124B	504	587	616	652	715	728	782	827

W392124	506	587	616	655	719	731	791	832
---------	-----	-----	-----	-----	-----	-----	-----	-----

- 24" deep cabinets must be fully supported by screws installed in a structural member in the ceiling or soffit, and into adjacent cabinets or tall panels.
- Load limit is 15 lbs. per square foot of load bearing surface.

Modifications

ADDTK	AUTH	CBO	CCO	CFNTO	CFRMO	CND	EX	FB	FDRW	FPEB	FTK	FTK_V	FULL/MFO	ID	MI	NSCH	P	RD	RECTKL/R
•	•		•				•	•		•	•	•*	•	•	•			•	

*FTKAV/FTKVV not available on W372124B.

Construction Upgrades

APU	PEU
•	•

Decorative Door Options

CG	MD
•	

Wall Single Door, 24" High

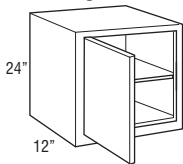

W1224 L or R	246	284	297	318	366	372	406	430
W1524 L or R	261	300	316	338	388	393	431	455
W1824 L or R	276	318	333	357	410	417	456	483
W2124 L or R	314	363	382	407	459	466	503	531
W2424 L or R	351	407	429	458	507	515	551	579

Modifications

ADDTK	AUTH	CBO	CCO	CFNTO	CFRMO	CND	EX	FB	FDRW	FPEB	FTK	FTK_V	FULL/MFO	ID	MI	NSCH	P	RD	RECTKL/R
•	•		•				•	•		•	•	•*	•	•	•			•	

*FTKAV/FTKVV not available on W1224.

Construction Upgrades

APU	PEU
•	•

Decorative Door Options

CG	MD
•	•†

†MD not available on W1224.

Wall Double Door, 24" High

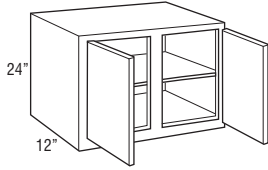
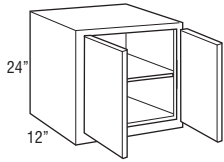

	1	2	3	4	5	6	7	8
W2424B	367	431	452	481	534	542	579	608
W2724B	424	503	528	561	619	630	675	710
W3024B	429	513	540	572	636	645	690	732
W3324B	455	541	569	601	671	678	732	775
W3624B	470	570	598	633	695	704	768	803
W3724B	475	574	603	640	701	711	774	810
W3924	481	578	607	646	706	717	780	817
W4224	504	612	643	681	733	742	806	851
W4524	523	633	665	704	767	779	849	894
W4824	544	655	688	732	804	817	885	938

Modifications

ADDTK	AUTH	CBO	CCO	CFNTO	CFRMO	CND	EX	FB	FDRW	FPEB	FTK	FTK_V	FULL/MFO	ID	MI	NSCH	P	RD	RECTKL/R
•	•	•	•	•	•	•	•	•	•	•	•	•*	•	•	•	•	•	•	•

*FTKAV/FTKFV not available on W3724B.

Construction Upgrades

APU	PEU
•	•

Decorative Door Options

CG	MD
•	•

Wall Double Door, 24" High, 24" Deep

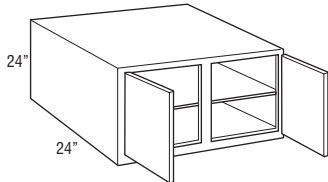
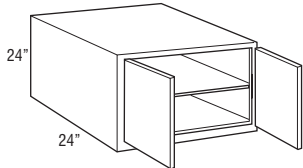

W302424B	477	570	600	635	706	716	766	813
W332424B	508	608	640	677	741	755	825	872
W362424B	551	648	680	721	783	792	855	908
W372424B	556	652	684	726	788	799	857	909
W392424	560	655	688	732	793	805	859	909

- 24" deep cabinets must be fully supported by screws installed in a structural member in the ceiling or soffit, and into adjacent cabinets or tall panels.
- Load limit is 15 lbs. per square foot of load bearing surface.
- Shelf is 21" deep on W392424 to allow for the shelf to be removed from the cabinet.

Modifications

ADDTK	AUTH	CBO	CCO	CFNTO	CFRMO	CND	EX	FB	FDRW	FPEB	FTK	FTK_V	FULL/MFO	ID	MI	NSCH	P	RD	RECTKL/R
•	•	•	•	•	•	•	•	•	•	•	•	•*	•	•	•	•	•	•	•

*FTKAV/FTKFV not available on W372424B.

Construction Upgrades

APU	PEU
•	•

Decorative Door Options

CG	MD
•	•†

†MD not available on W372424B and W392424.

Wall Single Door, 27" High

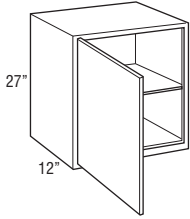

W1227 L or R	332	401	421	447	498	505	542	572
W1527 L or R	352	424	446	473	527	535	573	606
W1827 L or R	372	449	472	500	558	566	607	642
W2127 L or R	384	462	486	515	574	582	625	660
W2427 L or R	394	474	498	528	590	598	642	677

Modifications

ADDTK	AUTH	CBO	CCO	CFNTO	CFRMO	CND	EX	FB	FDRW	FPEB	FTK	FTK_V	FULL/MFO	ID	MI	NSCH	P	RD	RECTKL/R
•	•	•	•	•	•	•	•	•	•	•	•	•*	•	•	•	•	•	•	•

*FTKAV/FTKRV not available on W1227.

Construction Upgrades

APU	PEU
•	•

Decorative Door Options

CG	MD
•	

Wall Double Door, 27" High

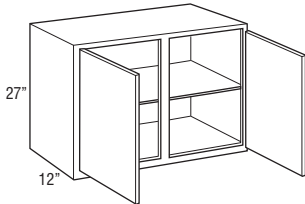
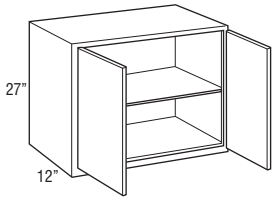

W2427B	415	499	524	556	620	630	676	712
W2727B	436	527	555	587	655	666	712	754
W3027B	442	533	560	593	662	673	720	760
W3327B	466	562	591	625	702	710	771	806
W3627B	491	592	620	658	725	735	802	843
W3727B	503	604	633	670	738	747	814	855

W3927	515	615	644	681	749	758	825	866
W4227	541	646	676	715	786	796	866	909
W4527	568	678	710	751	825	836	909	954
W4827	670	800	838	886	974	986	1073	1126

Modifications

ADDTK	AUTH	CBO	CCO	CFNTO	CFRMO	CND	EX	FB	FDRW	FPEB	FTK	FTK_V	FULL/MFO	ID	MI	NSCH	P	RD	RECTKL/R
•	•	•	•	•	•	•	•	•	•	•	•	•*	•	•	•	•	•	•	•

*FTKAV/FTKRV not available on W3727B.

Construction Upgrades

APU	PEU
•	•

Decorative Door Options

CG	MD
•	

Wall Double Door, 27" High, 24" Deep

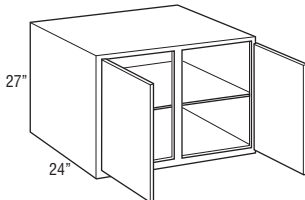
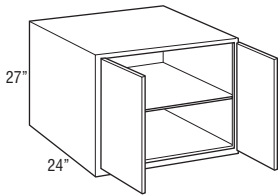

W302724B	495	598	629	667	741	751	827	867
W332724B	521	629	662	702	780	791	870	913
W362724B	579	676	708	755	804	817	895	948
W372724B	593	689	721	769	817	830	909	961

W392724	605	702	734	781	829	843	921	973
----------------	-----	-----	-----	-----	-----	-----	-----	-----

- 24" deep cabinets must be fully supported by screws installed in a structural member in the ceiling or soffit, and into adjacent cabinets or tall panels.
- Load limit is 15 lbs. per square foot of load bearing surface.

Modifications

ADDTK	AUTH	CBO	CCO	CFNTO	CFRMO	CND	EX	FB	FDRW	FPEB	FTK	FTK_V	FULL/MFO	ID	MI	NSCH	P	RD	RECTKL/R
•	•	•	•	•	•	•	•	•	•	•	•	•*	•	•	•	•	•	•	•

*FTKAV/FTKRV not available on W372724B.

Construction Upgrades

APU	PEU
•	•

Decorative Door Options

CG	MD
•	

Price
Point

Wall Single Door, 30" High

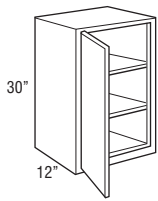

	1	2	3	4	5	6	7	8
W930 L or R	251	308	323	340	375	380	386	426
W1230 L or R	264	324	342	362	393	400	434	470
W1530 L or R	291	346	362	386	428	433	473	503
W1830 L or R	308	367	386	407	464	472	504	544
W2130 L or R	330	390	409	434	492	499	543	575
W2430 L or R	387	473	497	526	570	578	613	652

Modifications

ADDTK	AUTH	CBO	CCO	CFNTO	CFRMO	CND	EX	FB	FDRW	FPEB	FTK	FTK_V	FULL/MFO	ID	MI	NSCH	P	RD	RECTKL/R
•	•	•	•	•	•	•	•	•	•	•	•	•*	•	•	•	•	•	•	•

*FTKAV/FTKRV not available on W930 and W1230.

Construction Upgrades

APU	PEU
•	•

Decorative Door Options

CG	MD
•	• [†]

[†]MD not available on W930 and W1230.

Wall Double Door, 30" High

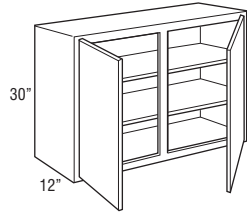
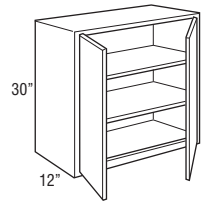

W2430B	405	497	522	554	601	611	645	688
W2730B	449	546	573	609	678	687	744	786
W3030B	455	555	580	616	681	694	758	793
W3330B	478	579	608	644	730	739	803	843
W3630B	510	608	640	677	755	764	832	879
W3930	527	626	658	697	777	789	868	908
W4230	544	645	677	717	804	817	896	947
W4530	568	676	709	754	850	862	945	998
W4830	591	708	744	791	886	901	997	1051

Modifications

ADDTK	AUTH	CBO	CCO	CFNTO	CFRMO	CND	EX	FB	FDRW	FPEB	FTK	FTK_V	FULL/MFO	ID	MI	NSCH	P	RD	RECTKL/R
•	•	•	•	•	•	•	•	•	•	•	•	•	•	•	•	•	•	•	•

Construction Upgrades

APU	PEU
•	•

Decorative Door Options

CG	MD
•	•

Wall Single Door, 33" High

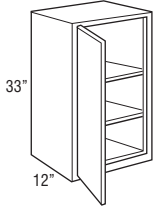

	1	2	3	4	5	6	7	8
W933 L or R	301	357	375	393	443	450	455	522
W1233 L or R	322	383	402	426	475	483	518	561
W1533 L or R	354	410	431	454	517	523	570	605
W1833 L or R	367	430	451	480	555	562	603	644
W2133 L or R	392	461	484	511	578	587	645	678
W2433 L or R	451	534	560	595	662	672	713	756

Modifications

ADDTK	AUTH	CBO	CCO	CFNTO	CFRMO	CND	EX	FB	FDRW	FPEB	FTK	FTK_V	FULL/MFO	ID	MI	NSCH	P	RD	RECTKL/R
•	•	•	•	•	•	•	•	•	•	•	•	•*	•	•	•	•	•	•	•

*FTKAV/FTKRV not available on W933 and W1233.

Construction Upgrades

APU	PEU
•	•

Decorative Door Options

CG	MD
•	•†

†MD not available on W933 and W1233.

Wall Double Door, 33" High

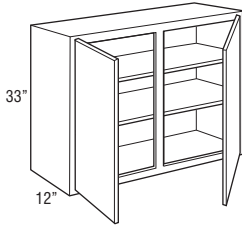
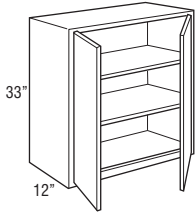

W2433B	475	562	591	625	698	707	734	795
W2733B	544	644	676	717	814	824	877	938
W3033B	554	650	681	726	830	844	916	970
W3333B	583	678	712	758	879	892	968	1018
W3633B	616	718	755	796	915	926	1014	1070
W3933	625	721	758	799	927	942	1029	1084
W4233	718	828	873	918	1067	1083	1184	1246
W4533	772	891	938	988	1147	1164	1273	1340
W4833	826	953	1002	1057	1227	1244	1362	1434

Modifications

ADDTK	AUTH	CBO	CCO	CFNTO	CFRMO	CND	EX	FB	FDRW	FPEB	FTK	FTK_V	FULL/MFO	ID	MI	NSCH	P	RD	RECTKL/R
•	•	•	•	•	•	•	•	•	•	•	•	•	•	•	•	•	•	•	•

Construction Upgrades

APU	PEU
•	•

Decorative Door Options

CG	MD
•	•

Wall Single Door, 36" High

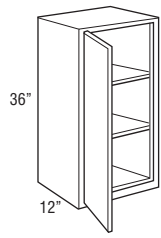

	1	2	3	4	5	6	7	8
W936 L or R	301	357	375	393	443	450	455	522
W1236 L or R	322	383	402	426	475	483	518	561
W1536 L or R	354	410	431	454	517	523	570	605
W1836 L or R	367	430	451	480	555	562	603	644
W2136 L or R	392	461	484	511	578	587	645	678
W2436 L or R	451	534	560	595	662	672	713	756

Modifications

ADDTK	AUTH	CBO	CCO	CFNTO	CFRMO	CND	EX	FB	FDRW	FPEB	FTK	FTK_V	FULL/MFO	ID	MI	NSCH	P	RD	RECTKL/R
•	•	•	•	•	•	•	•	•	•	•	•	•*	•	•	•	•	•	•	•

*FTKAV/FTKFV not available on W936 and W1236.

Construction Upgrades

APU	PEU
•	•

Decorative Door Options

CG	MD
•	• [†]

[†]MD not available on W936 and W1236.

Wall Double Door, 36" High

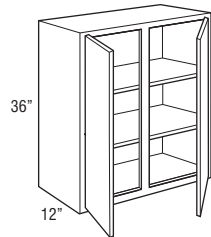
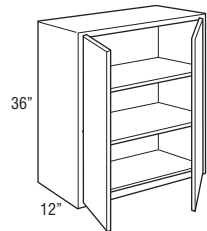

W2436B	475	562	591	625	698	707	734	795
W2736B	544	644	676	717	814	824	877	938
W3036B	554	650	681	726	830	844	916	970
W3336B	583	678	712	758	879	892	968	1018
W3636B	616	718	755	796	915	926	1014	1070
W3936	625	721	758	799	927	942	1029	1084
W4236	718	828	873	918	1067	1083	1184	1246
W4536	772	891	938	988	1147	1164	1273	1340
W4836	826	953	1002	1057	1227	1244	1362	1434

Modifications

ADDTK	AUTH	CBO	CCO	CFNTO	CFRMO	CND	EX	FB	FDRW	FPEB	FTK	FTK_V	FULL/MFO	ID	MI	NSCH	P	RD	RECTKL/R
•	•	•	•	•	•	•	•	•	•	•	•	•	•	•	•	•	•	•	•

Construction Upgrades

APU	PEU
•	•

Decorative Door Options

CG	MD
•	•

Wall Single Door, 39" High

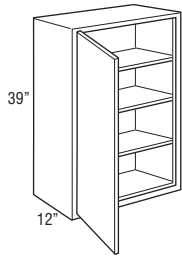

	1	2	3	4	5	6	7	8
W939 L or R	324	386	404	426	478	486	492	562
W1239 L or R	348	413	432	460	513	521	559	606
W1539 L or R	383	443	465	491	558	566	614	652
W1839 L or R	397	464	488	519	600	609	650	697
W2139 L or R	425	497	522	552	623	633	698	733
W2439 L or R	489	576	605	643	713	726	770	816

Modifications

ADDTK	AUTH	CBO	CCO	CFNTO	CFRMO	CND	EX	FB	FDRW	FPEB	FTK	FTK_V	FULL/MFO	ID	MI	NSCH	P	RD	RECTKL/R	
•	•	•	•	•	•	•	•	•	•	•	•	•*	•	•	•	•	•	•	•	•

*FTKAV/FTKRV not available on W939 and W1239.

Construction Upgrades

APU	PEU
•	•

Decorative Door Options

CG	MD
•	•†

†MD not available on W939 and W1239.

Wall Double Door, 39" High

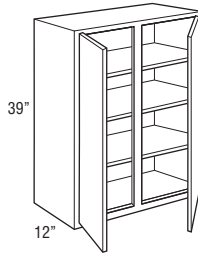
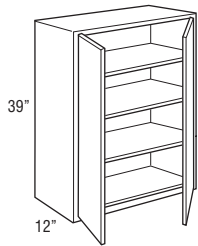

W2439B	513	607	637	675	754	764	792	857
W2739B	589	697	731	772	877	888	946	1013
W3039B	596	704	739	783	898	912	990	1045
W3339B	629	734	771	818	951	965	1045	1099
W3639B	666	775	815	859	988	1003	1097	1156
W3939	675	780	820	863	1002	1019	1112	1169
W4239	777	898	943	994	1155	1170	1278	1345
W4539	835	965	1014	1069	1242	1258	1374	1447
W4839	892	1032	1085	1143	1328	1346	1470	1548

Modifications

ADDTK	AUTH	CBO	CCO	CFNTO	CFRMO	CND	EX	FB	FDRW	FPEB	FTK	FTK_V	FULL/MFO	ID	MI	NSCH	P	RD	RECTKL/R	
•	•	•	•	•	•	•	•	•	•	•	•	•	•	•	•	•	•	•	•	•

Construction Upgrades

APU	PEU
•	•

Decorative Door Options

CG	MD
•	•

Wall Single Door, 42" High

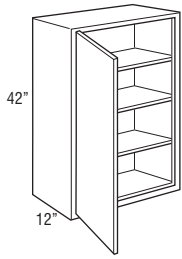

	1	2	3	4	5	6	7	8
W942 L or R	357	410	431	454	507	515	533	609
W1242 L or R	380	433	455	486	558	566	603	646
W1542 L or R	409	473	497	524	602	612	662	704
W1842 L or R	428	498	523	555	639	647	700	744
W2142 L or R	456	531	558	590	669	677	744	784
W2442 L or R	519	597	627	662	754	764	816	859

Modifications

ADDTK	AUTH	CBO	CCO	CFNTD	CFRMO	CND	EX	FB	FDRW	FPEB	FTK	FTK_V	FULL/MFO	ID	MI	NSCH	P	RD	RECTKL/R
•	•	•	•	•	•	•	•	•	•	•	•	•*	•	•	•	•	•	•	•

*FTKAV/FTKVF not available on W942 and W1242.

Construction Upgrades

APU	PEU
•	•

Decorative Door Options

CG	MD
•	• [†]

[†]MD not available on W942 and W1242.

Wall Double Door, 42" High

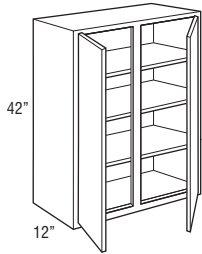
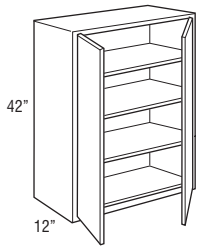

W2442B	544	627	659	698	792	804	830	906
W2742B	637	733	769	814	943	957	1018	1086
W3042B	653	754	789	830	981	996	1081	1139
W3342B	681	786	823	875	1026	1039	1132	1196
W3642B	718	823	864	915	1074	1091	1190	1255
W3942	735	840	881	927	1085	1101	1208	1271
W4242	846	965	1013	1067	1247	1267	1389	1462
W4542	909	1037	1089	1147	1341	1361	1493	1571
W4842	971	1109	1165	1227	1435	1455	1596	1680

Modifications

ADDTK	AUTH	CBO	CCO	CFNTD	CFRMO	CND	EX	FB	FDRW	FPEB	FTK	FTK_V	FULL/MFO	ID	MI	NSCH	P	RD	RECTKL/R
•	•	•	•	•	•	•	•	•	•	•	•	•	•	•	•	•	•	•	•

Construction Upgrades

APU	PEU
•	•

Decorative Door Options

CG	MD
•	•

**Wall Three Drawer Single Door,
48", 51", 54", 57", or 60" High**

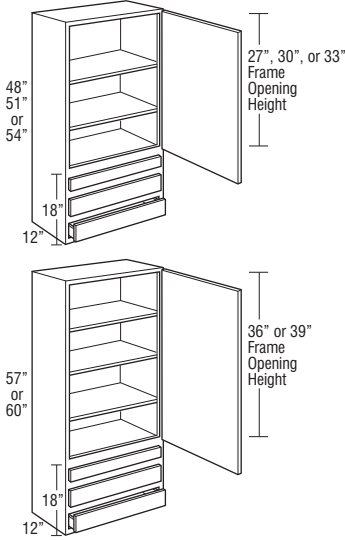

Price Point	1	2	3	4	5	6	7	8
W3D1548 L or R	607	717	754	800	841	871	923	1017
W3D1848 L or R	657	779	817	866	908	936	996	1099
W3D2448 L or R	790	933	980	1042	1094	1132	1200	1328
W3D1551 L or R	729	864	908	963	1007	1042	1108	1223
W3D1851 L or R	788	931	978	1037	1089	1126	1195	1319
W3D2451 L or R	948	1124	1180	1250	1311	1358	1442	1590
W3D1554 L or R	729	864	908	963	1007	1042	1108	1223
W3D1854 L or R	788	931	978	1037	1089	1126	1195	1319
W3D2454 L or R	948	1124	1180	1250	1311	1358	1442	1590
W3D1557 L or R	764	908	953	1009	1059	1096	1164	1281
W3D1857 L or R	826	978	1026	1091	1142	1183	1256	1388
W3D2457 L or R	999	1180	1239	1313	1376	1424	1514	1670
W3D1560 L or R	844	1001	1052	1112	1167	1207	1281	1416
W3D1860 L or R	913	1078	1133	1200	1261	1303	1386	1530
W3D2460 L or R	1099	1302	1367	1450	1519	1572	1670	1843

- Includes one shallow depth drawer and two standard drawers with undermount SoftTouch guides.
- Top drawer will be slab drawer front for all 5-piece drawer applications. Waldron PureStyle™ slab drawer front will be painted hardwood.
- Drawer front to face frame reveal is justified to the top to be consistent with overlay. Bottom reveal is 7/8" for full/modified full overlay and 1" for traditional overlay.

Modifications

ADDTK	AUTH	CBO	CCO	CFNTO	CFRMO	CND	EX	FB	FDRW	FPEB	FTK	FTK_V	FULL/MFO	ID	MI	NSCH	P	RD	RECTKL/R
•	•	•	•	•	•	•	•	•	•	•	•	•	•	•	•	•	•	•	•

Construction Upgrades

APU	PEU
•	•

Decorative Door Options

CG	MD
•	•

**Wall Three Drawer Double Door,
48", 51", 54", 57", or 60" High**

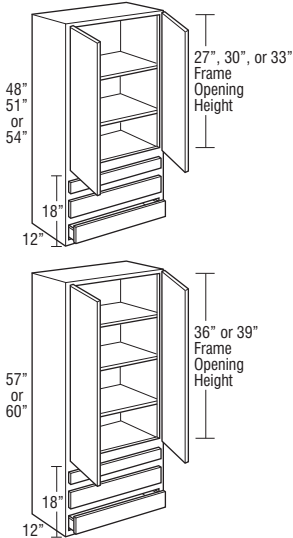

W3D2448B	831	983	1032	1097	1148	1190	1201	1397
W3D2451B	999	1183	1242	1314	1381	1429	1441	1673
W3D2454B	999	1183	1242	1314	1381	1429	1441	1673
W3D2457B	1049	1240	1303	1382	1450	1498	1513	1760
W3D2460B	1156	1370	1439	1524	1600	1623	1648	1939

- Includes one shallow depth drawer and two standard drawers with undermount SoftTouch guides.
- Top drawer will be slab drawer front for all 5-piece drawer applications. Waldron PureStyle™ slab drawer front will be painted hardwood.
- Drawer front to face frame reveal is justified to the top to be consistent with overlay. Bottom reveal is 7/8" for full/modified full overlay and 1" for traditional overlay.

Modifications

ADDTK	AUTH	CBO	CCO	CFNTO	CFRMO	CND	EX	FB	FDRW	FPEB	FTK	FTK_V	FULL/MFO	ID	MI	NSCH	P	RD	RECTKL/R
•	•	•	•	•	•	•	•	•	•	•	•	•	•	•	•	•	•	•	•

Construction Upgrades

APU	PEU
•	•

Decorative Door Options

CG	MD
•	•

Stacked Wall Cabinets Single Door, 48" High

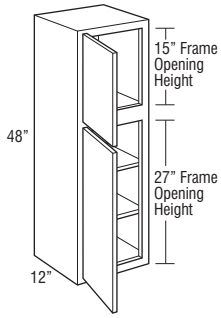

	1	2	3	4	5	6	7	8
STW1248 L or R	521	624	658	696	755	769	821	883
STW1548 L or R	564	664	695	740	813	823	882	938
STW1848 L or R	596	705	740	782	870	886	937	1005
STW2148 L or R	629	740	776	823	914	928	993	1053
STW2448 L or R	698	835	877	929	1007	1023	1078	1147

Modifications

ADDTK	AUTH	CBO	CCO	CFNTO	CFRMO	CND	EX	FB	FDRW	FPEB	FTK	FTK_V	FULL/MFO	ID	MI	NSCH	P	RD	RECTKL/R
	•	•	•	•	•	•	•	•	•	•	•	•	•	•	•	•	•	•	•

Construction Upgrades

APU	PEU
•	•

Decorative Door Options

CGCG	CGSD	MDMD	MDS	SDCG	SDMD	SDDS
•	•	•†	•†	•	•†	STD

†MDMD, MDS, and SDMD not available on STW1248.

Stacked Wall Cabinets Double Door, 48" High

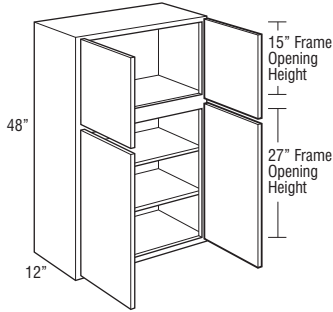

STW2448B	730	880	924	980	1062	1078	1135	1211
STW2748B	761	917	962	1017	1114	1132	1201	1286
STW3048B	829	995	1041	1105	1228	1251	1348	1426
STW3348B	885	1070	1121	1186	1331	1350	1461	1542
STW3648B	895	1060	1115	1183	1331	1348	1448	1534

Modifications

ADDTK	AUTH	CBO	CCO	CFNTO	CFRMO	CND	EX	FB	FDRW	FPEB	FTK	FTK_V	FULL/MFO	ID	MI	NSCH	P	RD	RECTKL/R
	•	•	•	•	•	•	•	•	•	•	•	•	•	•	•	•	•*	•	•

*P not available on STW3948 and STW4248.

Construction Upgrades

APU	PEU
•	•

Decorative Door Options

CGCG	CGSD	MDMD	MDS	SDCG	SDMD	SDDS
•	•	•	•	•	•	STD

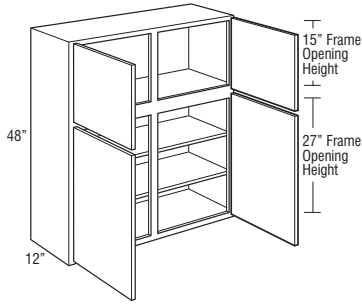

Stacked Wall Cabinets Single Door, 51" High

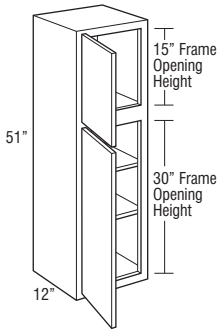

	Price Point	1	2	3	4	5	6	7	8
STW1251 L or R		579	683	718	760	837	852	905	974
STW1551 L or R		627	728	764	808	902	913	979	1040
STW1851 L or R		655	768	805	855	961	976	1036	1105
STW2151 L or R		691	811	851	900	1000	1016	1095	1156
STW2451 L or R		762	896	940	998	1099	1117	1178	1251

Modifications

ADDTK	AUTH	CBO	CCO	CFNTO	CFRMO	CND	EX	FB	FDRW	FPEB	FTK	FTK_V	FULL/MFO	ID	MI	NSCH	P	RD	RECTKL/R	

Construction Upgrades

APU	PEU

Decorative Door Options

CGCG	CGSD	MDMD	MDSO	SDCG	SDMD	SDSO

*MDMD, MDSO, and SDMD not available on STW1251.

Stacked Wall Cabinets Double Door, 51" High

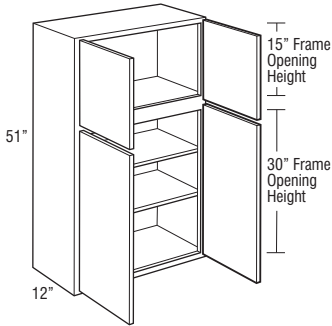

STW2451B	800	945	993	1051	1159	1174	1224	1318
STW2751B	900	1064	1116	1180	1327	1345	1433	1536
STW3051B	913	1074	1127	1193	1350	1371	1477	1573
STW3351B	957	1118	1173	1247	1426	1449	1558	1651
STW3651B	1001	1170	1230	1302	1491	1510	1630	1725

STW3951	1013	1177	1236	1308	1504	1528	1649	1748
STW4251	1113	1298	1367	1438	1675	1700	1835	1943

Modifications

ADDTK	AUTH	CBO	CCO	CFNTO	CFRMO	CND	EX	FB	FDRW	FPEB	FTK	FTK_V	FULL/MFO	ID	MI	NSCH	P	RD	RECTKL/R	
																		*		

*P not available on STW3951 and STW4251.

Construction Upgrades

APU	PEU

Decorative Door Options

CGCG	CGSD	MDMD	MDSO	SDCG	SDMD	SDSO

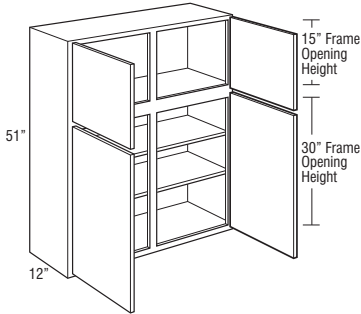

**Stacked Wall Cabinets Single Door,
54" High**

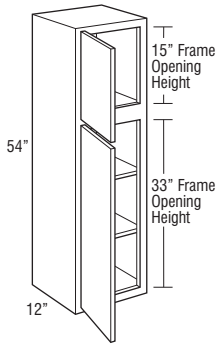

	1	2	3	4	5	6	7	8
STW1254 L or R	579	683	718	760	837	852	905	974
STW1554 L or R	627	728	764	808	902	913	979	1040
STW1854 L or R	655	768	805	855	961	976	1036	1105
STW2154 L or R	691	811	851	900	1000	1016	1095	1156
STW2454 L or R	762	896	940	998	1099	1117	1178	1251

Modifications

ADDTK	AUTH	CBO	CCO	CFNTD	CFRMO	CND	EX	FB	FDRW	FPEB	FTK	FTK_V	FULL/MFO	ID	MI	NSCH	P	RD	RECTKL/R
•	•	•	•	•	•	•	•	•	•	•	•	•	•	•	•	•	•	•	•

Construction Upgrades

APU	PEU
•	•

Decorative Door Options

CGCG	CGSD	MDMD	MDSO	SDCG	SDMD	SDSO
•	•	•†	•†	•	•†	•

†MDMD, MDSO, and SDMD not available on STW1254.

70

**Stacked Wall Cabinets Double Door,
54" High**

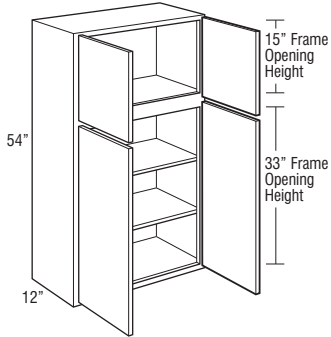

STW2454B	800	945	993	1051	1159	1174	1224	1318
STW2754B	900	1064	1116	1180	1327	1345	1433	1536
STW3054B	913	1074	1127	1193	1350	1371	1477	1573
STW3354B	957	1118	1173	1247	1426	1449	1558	1651
STW3654B	1001	1170	1230	1302	1491	1510	1630	1725

Modifications

ADDTK	AUTH	CBO	CCO	CFNTD	CFRMO	CND	EX	FB	FDRW	FPEB	FTK	FTK_V	FULL/MFO	ID	MI	NSCH	P	RD	RECTKL/R
•	•	•	•	•	•	•	•	•	•	•	•	•	•	•	•	•	•*	•	•

*P not available on STW3954 and STW4254.

Construction Upgrades

APU	PEU
•	•

Decorative Door Options

CGCG	CGSD	MDMD	MDSO	SDCG	SDMD	SDSO
•	•	•	•	•	•	•

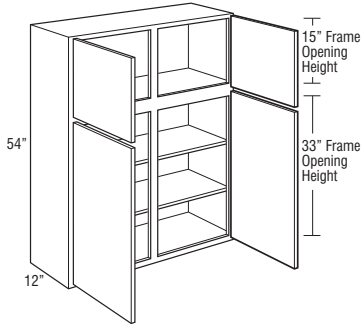

Stacked Wall Cabinets Single Door, 57" High

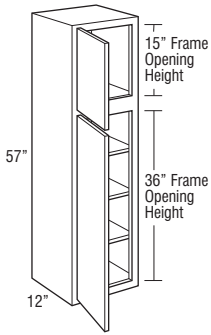

Price Point	1	2	3	4	5	6	7	8
STW1257 L or R	605	713	748	794	875	890	946	1019
STW1557 L or R	656	761	798	845	943	956	1023	1087
STW1857 L or R	685	802	842	894	1006	1023	1083	1158
STW2157 L or R	724	847	889	941	1045	1062	1148	1211
STW2457 L or R	800	938	985	1046	1150	1171	1235	1311

Modifications

ADDTK	AUTH	CBO	CCO	CFNTO	CFRMO	CND	EX	FB	FDRW	FPEB	FTK	FTK_V	FULL/MFO	ID	MI	NSCH	P	RD	RECTKL/R	
	•	•	•	•	•	•	•	•	•	•	•	•	•	•	•	•	•	•	•	•

Construction Upgrades

APU	PEU
•	•

Decorative Door Options

CGCG	CGSD	MDMD	MDSO	SDCG	SDMD	SOSO
•	•	•†	•†	•	•†	STD

†MDMD, MDSO, and SDMD not available on STW1257.

Stacked Wall Cabinets Double Door, 57" High

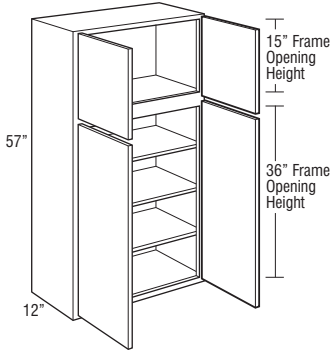

STW2457B	838	990	1039	1101	1215	1231	1282	1380
STW2757B	945	1117	1171	1235	1390	1409	1502	1611
STW3057B	955	1128	1185	1250	1418	1439	1551	1648
STW3357B	1003	1174	1232	1307	1498	1522	1635	1732
STW3657B	1051	1227	1290	1365	1564	1587	1713	1811

Modifications

ADDTK	AUTH	CBO	CCO	CFNTO	CFRMO	CND	EX	FB	FDRW	FPEB	FTK	FTK_V	FULL/MFO	ID	MI	NSCH	P	RD	RECTKL/R	
	•	•	•	•	•	•	•	•	•	•	•	•	•	•	•	•	•*	•	•	•

*P not available on STW3957 and STW4257.

Construction Upgrades

APU	PEU
•	•

Decorative Door Options

CGCG	CGSD	MDMD	MDSO	SDCG	SDMD	SOSO
•	•	•	•	•	•	STD

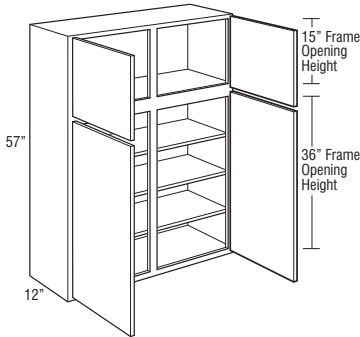

**Stacked Wall Cabinets Single Door,
60" High**

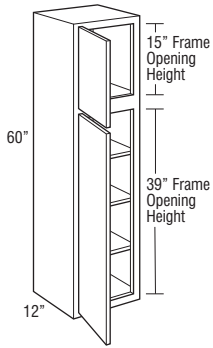

	1	2	3	4	5	6	7	8
STW1260 L or R	637	733	771	820	920	935	990	1059
STW1560 L or R	682	791	830	878	987	1002	1071	1139
STW1860 L or R	716	836	877	930	1045	1061	1133	1205
STW2160 L or R	755	881	925	979	1091	1106	1194	1262
STW2460 L or R	830	959	1007	1065	1191	1209	1281	1354

Modifications

ADDTK	AUTH	CBO	CCO	CFNTO	CFRMO	CND	EX	FB	FDRW	FPEB	FTK	FTK_V	FULL/MFO	ID	MI	NSCH	P	RD	RECTKL/R	

Construction Upgrades

APU	PEU

Decorative Door Options

CGCG	CGSD	MDMD	MDSO	SDCG	SDMD	SDSO

*MDMD, MDSO, and SDMD not available on STW1260.

**Stacked Wall Cabinets Double Door,
60" High**

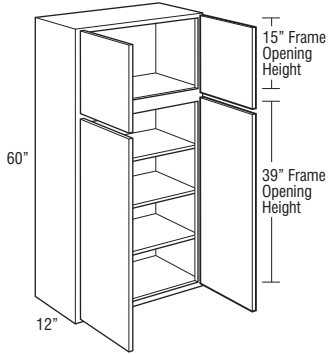

STW2460B	869	1010	1061	1124	1253	1271	1320	1429
STW2760B	993	1153	1209	1277	1456	1478	1574	1684
STW3060B	1012	1178	1235	1297	1501	1523	1642	1742
STW3360B	1055	1226	1284	1364	1573	1596	1722	1829
STW3660B	1103	1275	1339	1421	1650	1675	1806	1910

Modifications

ADDTK	AUTH	CBO	CCO	CFNTO	CFRMO	CND	EX	FB	FDRW	FPEB	FTK	FTK_V	FULL/MFO	ID	MI	NSCH	P	RD	RECTKL/R	

*P not available on STW3960 and STW4260.

Construction Upgrades

APU	PEU

Decorative Door Options

CGCG	CGSD	MDMD	MDSO	SDCG	SDMD	SDSO

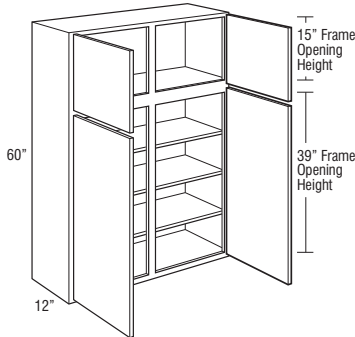

Wall Corner Cabinets

- Wall corner cabinets may be installed flush to the wall (left) or pulled 3" away from wall (right) to accommodate odd dimensions in a kitchen design. In either case, the adjoining run of 12" wall cabinets plus a 3" filler will butt against the solid-wood panel.
- When a cabinet is "pulled" it will use proportionally more wall space, for example, a 30" wide WC pulled 2" will use 32" of space.
- The BL or BR in the cabinet's nomenclature indicates the location of cabinet void.
- Blind side of wall corner cabinets cannot be installed next to a range hood or microwave shelf unit due to door interference.

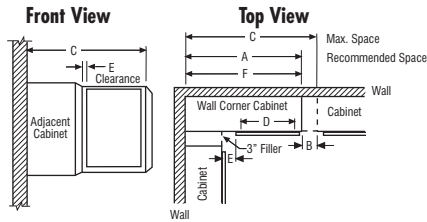

NOTE: All outside stiles are 1 1/2" wide

Model	A Recommended Space	B Max. Pull*	C Max. Space	D Face Frame Opening	E* Full/Modified Full At Min.	E* Full Overlay At Max.	E Traditional Overlay At Min.	E Traditional Overlay At Max.	F Actual Cabinet
WC24..	24"	5"	29"	7 1/2"	1 3/4"	6 3/4"	2 1/2"	7 1/2"	24"
WC27..	27"	4 1/2"	31 1/2"	9"	3 1/4"	7 3/4"	4"	8 1/2"	27"
WC30..	30"	5"	35"	13 1/2"	1 3/4"	6 3/4"	2 1/2"	7 1/2"	30"
WC33..	33"	4 1/2"	37 1/2"	15"	3 1/4"	7 3/4"	4"	8 1/2"	33"
WC36..	36"	5"	41"	19 1/2"	1 3/4"	6 3/4"	2 1/2"	7 1/2"	36"
WC42..	42"	4 1/2"	46 1/2"	24"	3 1/4"	7 3/4"	4"	8 1/2"	42"
WC48..	48"	4 1/2"	52 1/2"	30"	3 1/4"	7 3/4"	4"	8 1/2"	48"

*Minimum/maximum space between inside edge of door and face of filler/adjointing cabinet.
If cabinet is pulled to maximum stated dimension, filler will need to be created for proper attachment.

Wall Corner Single Door, 30" High	Price Point	1	2	3	4	5	6	7	8
		WC2430 BL or BR	358	421	443	467	519	526	570
WC2730 BL or BR	371	436	459	489	537	546	595	631	
WC3030 BL or BR	387	461	484	511	571	579	620	662	
WC3330 BL or BR	421	500	526	559	613	622	672	709	
WC3630 BL or BR	432	519	544	577	647	658	707	754	

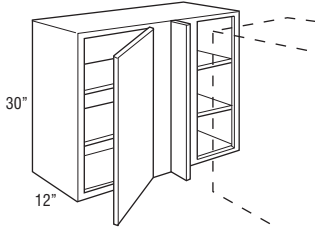

- BL or BR indicates void. BR (right) void shown.
- Includes one 3" filler, shipped unattached.

Modifications

ADDTK	AUTH	CBO	CCO	CFNTO	CFRMO	CND	EX	FB	FDRW	FPFB	FTK	FTK_V	FULL/MFO	ID	MI	NSCH	P	RD	RECTKL/R
•	•	•	•	•	•	•	•	•	•	•	•	•	•	•	•	•	•	•	•

Construction Upgrades

APU	PEU
•	•

Decorative Door Options

CG	MD

Wall Corner Double Door, 30" High	Price Point	1	2	3	4	5	6	7	8
		WC4230 BL or BR	561	662	697	739	815	825	886
WC4830 BL or BR	591	703	737	783	898	911	983	1031	

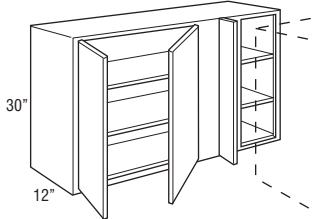

- BL or BR indicates void. BR (right) void shown.
- Includes one 3" filler, shipped unattached.

Modifications

ADDTK	AUTH	CBO	CCO	CFNTO	CFRMO	CND	EX	FB	FDRW	FPFB	FTK	FTK_V	FULL/MFO	ID	MI	NSCH	P	RD	RECTKL/R
•	•	•	•	•	•	•	•	•	•	•	•	•	•	•	•	•	•	•	•

Construction Upgrades

APU	PEU
•	•

Decorative Door Options

CG	MD

Wall Corner Single Door, 33" High

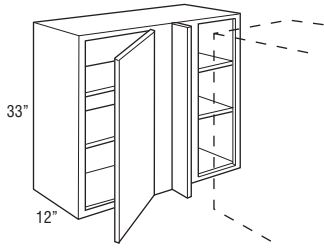

	1	2	3	4	5	6	7	8
WC2433 BL or BR	428	501	527	560	625	635	690	736
WC2733 BL or BR	452	529	556	589	658	668	734	778
WC3033 BL or BR	480	562	591	625	703	712	778	824
WC3333 BL or BR	509	599	629	666	748	760	833	882
WC3633 BL or BR	539	635	668	706	793	805	890	939

- BL or BR indicates void. BR (right) void shown.
- Includes one 3" filler, shipped unattached.

Modifications

ADDTK	AUTH	CBO	CCO	CFNT0	CFRMO	CND	EX	FB	FDRW	FPEB	FTK	FTK_V	FULL/MFO	ID	MI	NSCH	P	RD	RECTKL/R
•	•	•	•	•	•	•	•	•	•	•	•	•	•	•	•	•	•	•	•

Construction Upgrades

APU	PEU
•	•

Decorative Door Options

CG	MD

Wall Corner Single Door, 36" High

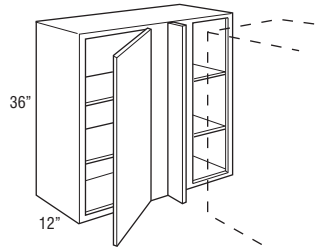

WC2436 BL or BR	428	501	527	560	625	635	690	736
WC2736 BL or BR	452	529	556	589	658	668	734	778
WC3036 BL or BR	480	562	591	625	703	712	778	824
WC3336 BL or BR	509	599	629	666	748	760	833	882
WC3636 BL or BR	539	635	668	706	793	805	890	939

- BL or BR indicates void. BR (right) void shown.
- Includes one 3" filler, shipped unattached.

Modifications

ADDTK	AUTH	CBO	CCO	CFNT0	CFRMO	CND	EX	FB	FDRW	FPEB	FTK	FTK_V	FULL/MFO	ID	MI	NSCH	P	RD	RECTKL/R
•	•	•	•	•	•	•	•	•	•	•	•	•	•	•	•	•	•	•	•

Construction Upgrades

APU	PEU
•	•

Decorative Door Options

CG	MD

Wall Corner Single Door, 39" High

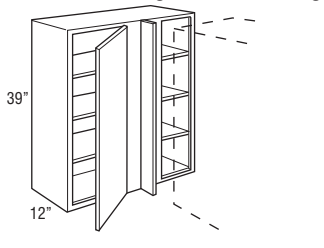

WC2439 BL or BR	461	542	570	605	675	683	746	795
WC2739 BL or BR	490	571	600	639	709	720	792	842
WC3039 BL or BR	519	607	637	675	758	768	842	891
WC3339 BL or BR	551	646	679	718	808	820	902	953
WC3639 BL or BR	583	685	720	761	857	873	963	1014

- BL or BR indicates void. BR (right) void shown.
- Includes one 3" filler, shipped unattached.

Modifications

ADDTK	AUTH	CBO	CCO	CFNT0	CFRMO	CND	EX	FB	FDRW	FPEB	FTK	FTK_V	FULL/MFO	ID	MI	NSCH	P	RD	RECTKL/R
•	•	•	•	•	•	•	•	•	•	•	•	•	•	•	•	•	•	•	•

Construction Upgrades

APU	PEU
•	•

Decorative Door Options

CG	MD

Wall Corner Single Door, 42" High

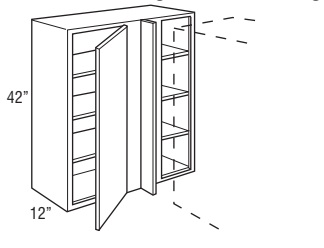

WC2442 BL or BR	499	582	611	649	731	740	813	864
WC2742 BL or BR	531	616	647	685	779	791	868	921
WC3042 BL or BR	572	660	694	735	833	847	925	975
WC3342 BL or BR	608	703	738	783	886	901	995	1051
WC3642 BL or BR	643	744	783	827	938	953	1063	1123

- BL or BR indicates void. BR (right) void shown.
- Includes one 3" filler, shipped unattached.

Modifications

ADDTK	AUTH	CBO	CCO	CFNT0	CFRMO	CND	EX	FB	FDRW	FPEB	FTK	FTK_V	FULL/MFO	ID	MI	NSCH	P	RD	RECTKL/R
•	•	•	•	•	•	•	•	•	•	•	•	•	•	•	•	•	•	•	•

Construction Upgrades

APU	PEU
•	•

Decorative Door Options

CG	MD

Price Point

**Wall Diagonal,
12", 15", 18", 24", or 27" High,
24" x 24"**

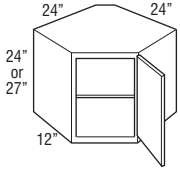
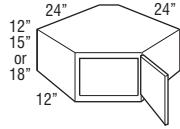

	1	2	3	4	5	6	7	8
WD2412 L or R	366	411	430	457	489	496	538	577
WD2415 L or R	386	432	453	481	515	522	567	607
WD2418 L or R	406	455	476	506	541	549	597	639
WD2424 L or R	451	503	528	561	600	609	662	708
WD2427 L or R	468	533	560	593	635	643	702	749

- Cabinets require 24" x 24" of corner wall space.
- To allow for proper door clearance of adjacent cabinets, all door styles regardless of overlay utilize 14 1/2" wide doors with a traditional overlay hinge.
- Adjustable shelf cannot be removed or retrofitted.

Modifications

ADDTK	AUTH	CBO	CCO	CFNTO	CFRMO	CND	EX	FB	FDRW	FPEB	FTK	FTK_V	FULL/MFO	ID	MI	NSCH	P	RD	RECTKL/R
		•	•*	•	•			•		•			•			•			

*CBO available only on WD2424 and WD2427. *CCO available only on WD2412, WD2415, and WD2418.

Construction Upgrades

APU	PEU
•	•

Decorative Door Options

CG	MD
•	•†

†MD not available on WD2412 and WD2427.

**Wall Diagonal,
30", 33", 36", 39", or 42" High,
24" x 24"**

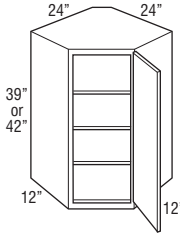
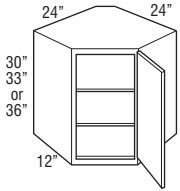

WD2430 L or R	484	562	591	625	669	677	742	790
WD2433 L or R	568	655	688	732	794	806	884	944
WD2436 L or R	568	655	688	732	794	806	884	944
WD2439 L or R	613	708	744	790	858	874	956	1021
WD2442 L or R	652	753	789	840	920	935	1028	1079

- Cabinets require 24" x 24" of corner wall space.
- To allow for proper door clearance of adjacent cabinets, all door styles regardless of overlay utilize 14 1/2" wide doors with a traditional overlay hinge.

Modifications

ADDTK	AUTH	CBO	CCO	CFNTO	CFRMO	CND	EX	FB	FDRW	FPEB	FTK	FTK_V	FULL/MFO	ID	MI	NSCH	P	RD	RECTKL/R
		•	•	•	•			•		•			•			•			

Construction Upgrades

APU	PEU
•	•

Decorative Door Options

CG	MD
•	•

**Wall Diagonal with Lazy Susan,
30", 33", 36", 39", or 42" High,
24" x 24"**

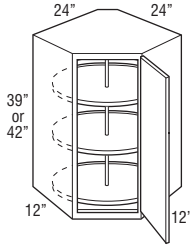
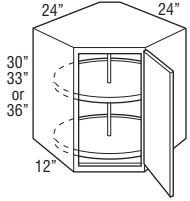

	1	2	3	4	5	6	7	8
WD2430S L or R	639	747	785	829	907	918	1004	1068
WD2433S L or R	753	864	909	965	1071	1087	1177	1258
WD2436S L or R	753	864	909	965	1071	1087	1177	1258
WD2439S L or R	813	934	981	1041	1157	1173	1272	1359
WD2442S L or R	868	977	1027	1088	1234	1251	1350	1447

- Cabinets require 24" x 24" of corner wall space.
- To allow for proper door clearance of adjacent cabinets, all door styles regardless of overlay utilize 1 1/2" wide doors with a traditional overlay hinge.
- Plywood shelves are 18" in overall diameter with a 17" interior diameter and 1" high lip.

Modifications

ADDTK	AUTH	CBO	CCO	CFNTD	CFRMO	CND	EX	FB	FDRW	FPEB	FTK	FTK_V	FULL/MFO	ID	MI	NSCH	P	RD	RECTKL/R
	•	•	•	•	•			•		•			•		•	•			

Construction Upgrades

APU	PEU
•	•

Decorative Door Options

CG	MD
•	•

**Wall Diagonal,
30", 33", 36", 39", or 42" High,
27" x 27"**

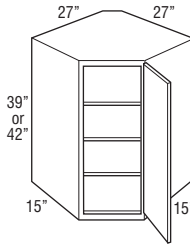
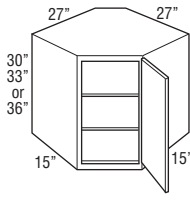

WD2730 L or R	603	703	737	783	839	851	930	994
WD2733 L or R	708	819	858	912	994	1008	1108	1174
WD2736 L or R	708	819	858	912	994	1008	1108	1174
WD2739 L or R	764	883	927	984	1072	1088	1196	1268
WD2742 L or R	817	939	986	1045	1150	1167	1286	1351

- Cabinets require 27" x 27" of corner wall space.
- To allow for proper door clearance of adjacent cabinets, all door styles regardless of overlay utilize 1 1/2" wide doors with a traditional overlay hinge.

Modifications

ADDTK	AUTH	CBO	CCO	CFNTD	CFRMO	CND	EX	FB	FDRW	FPEB	FTK	FTK_V	FULL/MFO	ID	MI	NSCH	P	RD	RECTKL/R
	•	•	•	•	•			•		•			•		•	•			

Construction Upgrades

APU	PEU
•	•

Decorative Door Options

CG	MD
•	•

**Stacked Diagonal Wall,
48", 51", 54", 57", or 60" High,
24" x 24"**

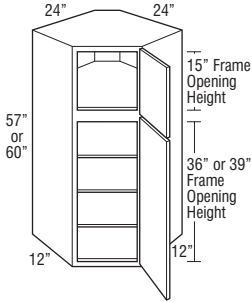
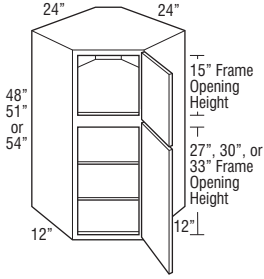

Price Point	1	2	3	4	5	6	7	8
STWD2448 L or R	890	1017	1067	1131	1210	1226	1339	1429
STWD2451 L or R	974	1110	1164	1238	1335	1355	1481	1583
STWD2454 L or R	974	1110	1164	1238	1335	1355	1481	1583

STWD2457 L or R	1019	1163	1220	1296	1399	1423	1553	1660
STWD2460 L or R	1058	1208	1265	1346	1461	1484	1625	1718

- Cabinets require 24" x 24" of corner wall space.
- To allow for proper door clearance of adjacent cabinets, all door styles regardless of overlay utilize 14 1/2" wide doors with a traditional overlay hinge.

Modifications

ADDTK	AUTH	CBO	CCO	CFNTO	CFRMO	CND	EX	FB	FDRW	FPEB	FTK	FTK_V	FULL/MFO	ID	MI	NSCH	P	RD	RECTKL/R
	•	•	•	•	•				•				•			•			

Construction Upgrades

APU	PEU
•	•

Decorative Door Options

CGCG	CGSD	MDMD	MDSO	SDCG	SDMD	SDSO
•	•	•	•	•	•	STD

**Stacked Diagonal Wall,
48", 51", 54", 57", or 60" High,
27" x 27"**

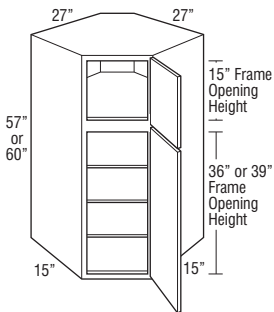
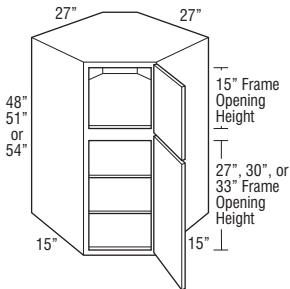

STWD2748 L or R	1218	1367	1422	1498	1589	1609	1736	1842
STWD2751 L or R	1323	1483	1543	1627	1744	1766	1914	2022
STWD2754 L or R	1323	1483	1543	1627	1744	1766	1914	2022

STWD2757 L or R	1379	1547	1612	1699	1822	1846	2002	2116
STWD2760 L or R	1432	1603	1671	1760	1900	1925	2092	2199

- Cabinets require 27" x 27" of corner wall space.
- To allow for proper door clearance of adjacent cabinets, all door styles regardless of overlay utilize 14 1/2" wide doors with a traditional overlay hinge.

Modifications

ADDTK	AUTH	CBO	CCO	CFNTO	CFRMO	CND	EX	FB	FDRW	FPEB	FTK	FTK_V	FULL/MFO	ID	MI	NSCH	P	RD	RECTKL/R
	•	•	•	•	•				•				•			•			

Construction Upgrades

APU	PEU
•	•

Decorative Door Options

CGCG	CGSD	MDMD	MDSO	SDCG	SDMD	SDSO
•	•	•	•	•	•	STD

Wall Corner Easy Reach, 30", 33", 36", 39", or 42" High, 24" x 24"

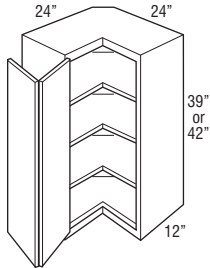
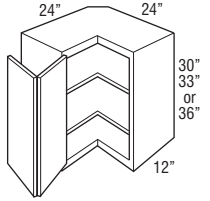

	1	2	3	4	5	6	7	8
WCER2430 L or R	562	653	687	731	780	792	868	931
WCER2433 L or R	659	764	801	852	930	943	1037	1098
WCER2436 L or R	659	764	801	852	930	943	1037	1098
WCER2439 L or R	710	825	868	920	1003	1021	1119	1184
WCER2442 L or R	759	877	920	973	1074	1090	1205	1268

- Cabinets require 24" x 24" of corner wall space.
- Hinged door opens to 170°.
- Decorative hardware screws must be countersunk to prevent scratching of adjacent cabinets and face frame of WCER.

Modifications

ADDTK	AUTH	CBO	CCO	CFNT0	CFRMO	CND	EX	FB	FDRW	FPEB	FTK	FTK_V	FULL/MFO	ID	MI	NSCH	P	RD	RECTKL/R	
																			• STD	

Construction Upgrades

APU	PEU
•	•

Decorative Door Options

CG	MD

Asymmetrical Wall Corner Easy Reach Cabinet, 30", 33", 36", 39", or 42" High

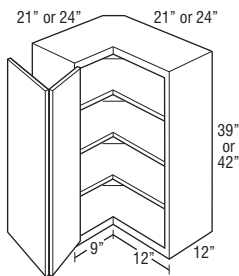
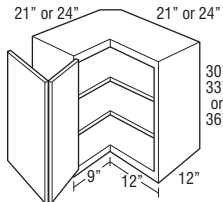

WCER212430 L or R	562	653	687	731	780	792	868	931
WCER242130 L or R	562	653	687	731	780	792	868	931
WCER212433 L or R	659	764	801	852	930	943	1037	1098
WCER242133 L or R	659	764	801	852	930	943	1037	1098
WCER212436 L or R	659	764	801	852	930	943	1037	1098
WCER242136 L or R	659	764	801	852	930	943	1037	1098
WCER212439 L or R	710	825	868	920	1003	1021	1119	1184
WCER242139 L or R	710	825	868	920	1003	1021	1119	1184
WCER212442 L or R	759	877	920	973	1074	1090	1205	1268
WCER242142 L or R	759	877	920	973	1074	1090	1205	1268

- Hinged door opens to 170°.
- Legs at the front frames are 9" on 21" leg and 12" on 24" leg.
- Nomenclature for asymmetrical cabinets reads as follows:
 First set of numbers = left side
 Second set of numbers = right side
 Third set of numbers = height
- Decorative hardware screws must be countersunk to prevent scratching of adjacent cabinets and face frame of WCER.
- WCER__2124L shown.

Modifications

ADDTK	AUTH	CBO	CCO	CFNT0	CFRMO	CND	EX	FB	FDRW	FPEB	FTK	FTK_V	FULL/MFO	ID	MI	NSCH	P	RD	RECTKL/R	
																			• STD	

Construction Upgrades

APU	PEU
•	•

Decorative Door Options

CG	MD

**Wall End Cabinet Single Door,
30", 33", 36", 39", or 42" High,
12" x 12"**



Top View

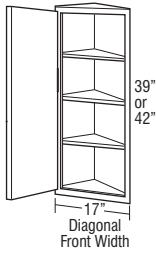
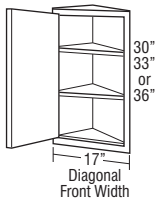

Price Point	1	2	3	4	5	6	7	8
WEC30 L or R	295	345	361	383	431	436	474	506
WEC33 L or R	311	365	383	406	454	461	495	533
WEC36 L or R	311	365	383	406	454	461	495	533
WEC39 L or R	317	375	393	419	464	472	506	547
WEC42 L or R	323	385	403	428	473	480	517	560

- Width at wall: 12" x 12".
- Cabinet features two unfinished back panels. Must be installed with one back panel adjacent to a cabinet of equal height with the other back panel attached to the wall.
- When ordered with MD, shelves will not align with mullions.

Modifications

ADTK	AUTH	CBO	CCO	CFNT0	CFRMO	CND	EX	FB	FDRW	FPEB	FTK	FTK_V	FULL/MFO	ID	MI	NSCH	P	RD	RECTKL/R	

Construction Upgrades

APU	PEU
•†	

Decorative Door Options

CG	MD
•	•

†APU constructed with 3/8" plywood ends.

**Wall Message Center Cabinet,
30", 33", 36", 39", or 42" High,
3" Deep, 12" Wide**

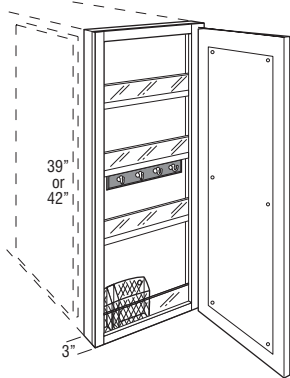
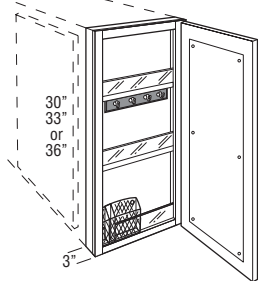

WMC1230 L or R	800	854	896	904	916	930	953	983
WMC1233 L or R	867	921	969	983	1005	1020	1043	1088
WMC1236 L or R	867	921	969	983	1005	1020	1043	1088
WMC1239 L or R	912	969	1016	1038	1059	1075	1098	1148
WMC1242 L or R	963	1011	1061	1090	1121	1138	1163	1219

- Includes magnetic whiteboard on back of door, key hooks, pencil holder, and fixed plexi-glass fronted shelves.
- Door will open 90° without decorative hardware.
- Cabinet should be hinged on wall side.
- Not available next to a Peninsula Cabinet.
- For proper installation, adjacent cabinet must have FPEB or 1/4" skin applied.
- Overlay fillers can be used on side of cabinet to add a decorative touch.

Modifications

ADTK	AUTH	CBO	CCO	CFNT0	CFRMO	CND	EX	FB	FDRW	FPEB	FTK	FTK_V	FULL/MFO	ID	MI	NSCH	P	RD	RECTKL/R	

Construction Upgrades

APU	PEU
•	

Decorative Door Options

CG	MD

Wall Microwave Cabinet, 18" High

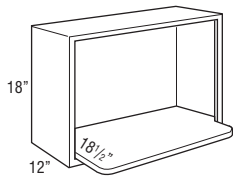

	1	2	3	4	5	6	7	8
MW2718	701	701	701	701	701	701	701	701
MW3018	752	752	752	752	752	752	752	752

- Includes one 3/4" shelf with six mounting screws. Shelf is hardwood veneer plywood. Microwave shelf extends beyond the front of the cabinet by 6 1/2", for a total shelf depth of 18 1/2".
- Microwave cabinet must be attached to wall stud and adjacent cabinets on both sides for support.
- Cabinet interior finished to match cabinet face frame.
- When ID is ordered, shelf will not be included.

Modifications

ADDTK	AUTH	CBO	CCO	CFNT0	CFRMO	CND	EX	FB	FDRW	FPEB	FTK	FTK_V	FULL/MFO	ID	MI	NSCH	P	RD	RECTKL/R	
			• STD																	

Construction Upgrades

APU	PEU

Decorative Door Options

CG	MD

	Opening		Cabinet	
	Width	Height	Width	Height
MW2718	24"	14 1/4"	27"	18"
MW3018	27"	14 1/4"	30"	18"

NEW **Wall Microwave Double Door Cabinet, 36", 39", or 42" High**

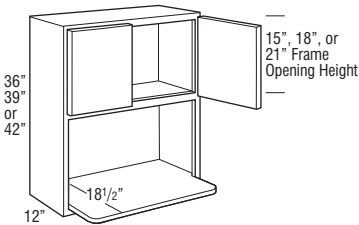

WMW2436B	774	853	895	901	922	938	998	1060
WMW2736B	815	898	942	948	971	987	1050	1116
WMW3036B	881	972	1023	1033	1054	1068	1143	1213
WMW2439B	835	921	967	986	998	1013	1074	1148
WMW2739B	879	969	1018	1038	1051	1066	1131	1208
WMW3039B	954	1052	1103	1131	1136	1156	1235	1310
WMW2442B	903	999	1048	1074	1084	1100	1166	1243
WMW2742B	951	1052	1103	1131	1141	1158	1227	1308
WMW3042B	1041	1149	1208	1230	1243	1261	1347	1434

- Includes one 3/4" shelf with six mounting screws. Shelf is hardwood veneer plywood. Microwave shelf extends beyond the front of the cabinet by 6 1/2", for a total shelf depth of 18 1/2".
- 42" high cabinets include one adjustable shelf in the upper section.
- Microwave cabinet must be attached to wall stud and adjacent cabinets on both sides for support.
- Cabinet interior finished to match cabinet face frame.
- When ID is ordered, shelf will not be included.

Modifications

ADDTK	AUTH	CBO	CCO	CFNT0	CFRMO	CND	EX	FB	FDRW	FPEB	FTK	FTK_V	FULL/MFO	ID	MI	NSCH	P	RD	RECTKL/R	

Construction Upgrades

APU	PEU

Decorative Door Options

CG	MD
•	

	Opening		Cabinet	
	Width	Height	Width	Height
WMW2436B	21"	15 3/4"	24"	36"
WMW2736B	24"	15 3/4"	27"	36"
WMW3036B	27"	15 3/4"	30"	36"
WMW2439B	21"	15 3/4"	24"	39"
WMW2739B	24"	15 3/4"	27"	39"
WMW3039B	27"	15 3/4"	30"	39"
WMW2442B	21"	15 3/4"	24"	42"
WMW2742B	24"	15 3/4"	27"	42"
WMW3042B	27"	15 3/4"	30"	42"

Wall Built-in Microwave Double Door Cabinet, 36", 39", or 42" High

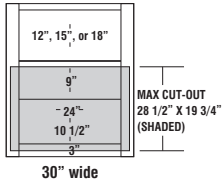
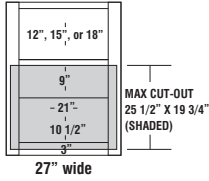
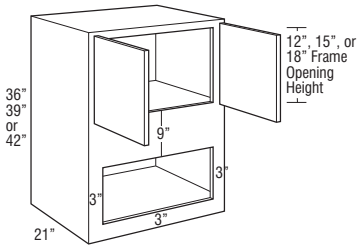

Price Point	1	2	3	4	5	6	7	8
WBMW273621	764	902	946	1004	1138	1155	1227	1313
WBMW303621	805	949	995	1058	1212	1230	1336	1416
WBMW273921	824	973	1023	1083	1227	1244	1325	1418
WBMW303921	870	1027	1078	1139	1310	1329	1442	1526
WBMW274221	891	1026	1077	1138	1320	1340	1424	1521
WBMW304221	954	1098	1151	1212	1431	1452	1576	1662

- Uses face mount hinges, doors and drawer fronts have a consistent width reveal for full/modified full overlay (1/4") and traditional overlay (1").
- Microwave cabinet must be attached to wall stud and adjacent cabinets on both sides for support.

Model	Factory Opening	Maximum Cut-out
WBMW27.. 21W x 10 1/2H	25 1/2W x 19 3/4H	
WBMW30.. 24W x 10 1/2H	28 1/2W x 19 3/4H	

Modifications

ADDTK	AUTH	CBO	CCO	CFNTO	CFRMO	CND	EX	FB	FDRW	FPEB	FTK	FTK_V	FULL/MFO	ID	MI	NSCH	P	RD	RECTKL/R	
			•																	•*

*RD to 15" available.

Construction Upgrades

APU	PEU
•	•

Decorative Door Options

CG	MD

Wall Spice Pull-out, 30", 33", 36", 39", or 42" High

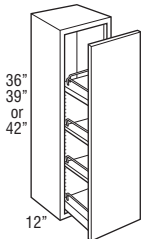
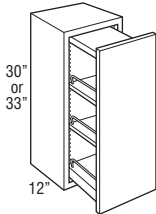

WSP930	728	748	764	779	788	803	819	863
WSP1230	741	765	780	795	804	820	836	882
WSP933	779	803	819	835	845	859	878	926
WSP1233	797	822	840	855	863	881	899	947

WSP936	779	803	819	835	845	859	878	926
WSP1236	797	822	840	855	863	881	899	947
WSP939	800	824	843	857	866	883	902	951
WSP1239	824	850	866	883	891	910	927	980
WSP942	832	857	876	892	902	918	937	990
WSP1242	856	882	901	917	927	946	966	1021

- 30" and 33" high units include a natural finish, full extension wood pull-out with two adjustable shelves, one fixed shelf, and chrome finish rail sides.
- Wood plugs for top of 30" to 33" high pull-out included for field installation.
- 36" to 42" high units include a natural finish, full extension wood pull-out with two adjustable shelves, two fixed shelves, and chrome finish rail sides.
- Wire for top rail on 36" to 42" high pull-out included separately for field installation.
- Shelf dimensions for 9" wide cabinets are 4 1/4" wide x 9 1/2" deep. Shelf dimensions for 12" wide cabinets are 7 1/4" x 9 1/2".

Modifications

ADDTK	AUTH	CBO	CCO	CFNTO	CFRMO	CND	EX	FB	FDRW	FPEB	FTK	FTK_V	FULL/MFO	ID	MI	NSCH	P	RD	RECTKL/R	
•	•	•	•																	

Construction Upgrades

APU	PEU
•	•

Decorative Door Options

CG	MD

Wall Outside End Shelf, Square Top, Square Bottom

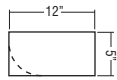

Top View

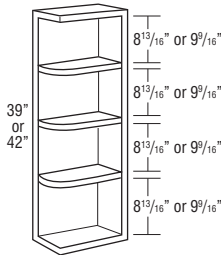
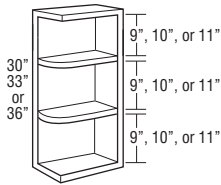

	1	2	3	4	5	6	7	8
WOC630STSB	344	344	344	344	344	344	344	344
WOC633STSB	449	449	449	449	449	449	449	449
WOC636STSB	449	449	449	449	449	449	449	449
WOC639STSB	484	484	484	484	484	484	484	484
WOC642STSB	556	556	556	556	556	556	556	556

- Units are reversible.
- Hardwood veneer on 3/4" furniture board core.
- Matching interior.
- Side is 1/4" plywood designed to fit behind front frame.
- When ordering Rustic Hickory, Hickory will be substituted.
- Shelves are fixed.

MODIFICATIONS

No modifications available for these products.

Construction Upgrades

APU	PEU
•	

Wall Appliance Garage Doors

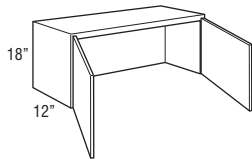
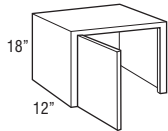

WAGD18 L or R	446	446	446	446	446	446	446	446
WAGD24 L or R	499	499	499	499	499	499	499	499
WAGD24B	499	499	499	499	499	499	499	499
WAGD27B	528	528	528	528	528	528	528	528
WAGD30B	580	580	580	580	580	580	580	580
WAGD33B	640	640	640	640	640	640	640	640
WAGD36B	704	704	704	704	704	704	704	704

- Cabinet does not have a bottom (floor).
- Bottom edge is not trimmable.
- Standard cabinet interior, order MI for matching interior.
- Cabinet is designed to fit beneath standard wall cabinets.

Modifications

ADDTK	AUTH	CBO	CCO	CFNTO	CFRMO	CND	EX	FB	FDRW	FPEB	FTK	FTK_V	FULL/MFO	ID	MI	NSCH	P	RD	RECTKL/R
			•	•	•				•	•			•	•	•				

Construction Upgrades

APU	PEU
•	•

Decorative Door Options

CG	MD

Wall Diagonal Appliance Garage Doors

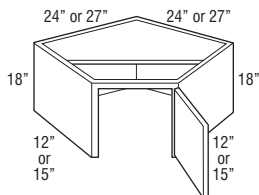

WDAGD1812 L or R	446	446	446	446	446	446	446	446
WDAGD1815 L or R	536	536	536	536	536	536	536	536

- WDAGD1812 requires 24" x 24" wall space.
- WDAGD1815 requires 27" x 27" wall space.
- Cabinet is designed to fit beneath diagonal wall cabinets.
- Cabinet has partial top and no floor.
- To allow for proper door clearance of adjacent cabinets, all door styles regardless of overlay utilize 1 1/2" wide doors with a traditional overlay hinge.

Modifications

ADDTK	AUTH	CBO	CCO	CFNTO	CFRMO	CND	EX	FB	FDRW	FPEB	FTK	FTK_V	FULL/MFO	ID	MI	NSCH	P	RD	RECTKL/R
			•	•	•				•	•			•	•	•				

Construction Upgrades

APU	PEU
•	•

Decorative Door Options

CG	MD

Wall Pull-out Filler, Plain

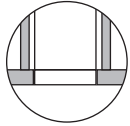
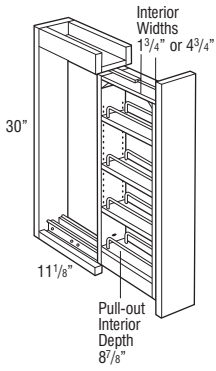

Top View

WPOF3PL	353	353	353	353	353	353	353	353
WPOF6PL	450	450	450	450	450	450	450	450

- Recommend installation between two cabinets. Can be installed on the end of a run with the use of a 3/4" thick end panel.
- All styles feature a natural finish wood pull-out with adjustable shelves and chrome rail sides.
- Actual space required is 3 1/8" and 6 1/8" wide.
- Full extension guide standard.
- Includes filler.
- Not compatible with face mount moulding.

MODIFICATIONS
No modifications available for these products.

Wall Pull-out Filler, Overlay

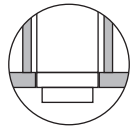
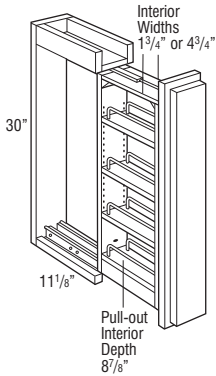

Top View

WPOF3OV	385	385	385	385	385	385	385	385
WPOF6OV	501	501	501	501	501	501	501	501

- Recommend installation between two cabinets. Can be installed on the end of a run with the use of a 3/4" thick end panel.
- Overlay application includes profiled overlay and filler.
- Waldron PureStyle™ overlays will be painted hardwood.
- All styles feature a natural finish wood pull-out with adjustable shelves and chrome rail sides.
- Actual space required is 3 1/8" and 6 1/8" wide.
- Full extension guide standard.
- Not compatible with face mount moulding.

Modifications
ADDTK AUTH CBO CCO CFNTO CFRMO CND EX FB FDRW FPEB FTK FTK_V FULL/MFO ID MI NSCH P RD RECTKL/R
•

Construction Upgrades
APU PEU

Decorative Door Options
CG MD

Wine Storage Cabinets

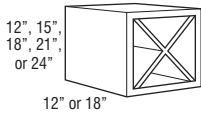

SKU	# of Bottles
WSC121212	4
WSC151512	10
WSC181812	18
WSC181818	18
WSC212112	24
WSC242412	32

WSC121212	515	515	515	515	515	515	515	515
WSC151512	536	536	536	536	536	536	536	536
WSC181812	579	579	579	579	579	579	579	579
WSC181818	629	629	629	629	629	629	629	629
WSC212112	591	591	591	591	591	591	591	591
WSC242412	627	627	627	627	627	627	627	627

- Must be installed between two cabinets, between cabinet and wall, or mounted to a horizontal surface.
- "X" configuration cannot be removed.

Modifications
ADDTK AUTH CBO CCO CFNTO CFRMO CND EX FB FDRW FPEB FTK FTK_V FULL/MFO ID MI NSCH P RD RECTKL/R
• STD •*

*RD not recommended for safe wine bottle storage.

Construction Upgrades
APU PEU

Decorative Door Options
CG MD

Wall Wine Rack

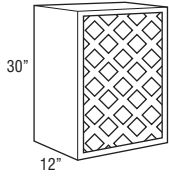
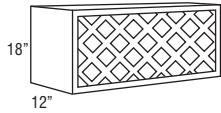

SKU	# of Bottles
3018WR, 1830WR	11
3618WR	13

	1	2	3	4	5	6	7	8
3018WR	762	762	762	762	762	762	762	762
3618WR	833	833	833	833	833	833	833	833
1830WR	762	762	762	762	762	762	762	762

- Hardwood veneer plywood with solid-wood lattice work.
- Wine bottle opening 4" x 4".

Modifications

ADDTK	AUTH	CBO	CCO	CFNT0	CFRMO	CND	EX	FB	FDRW	FPEB	FTK	FTK_V	FULL/MFO	ID	MI	NSCH	P	RD	RECTKL/R
•					•		•			•	•				STD				•

Construction Upgrades

APU	PEU

Decorative Door Options

CG	MD

Wall Wine Cubby

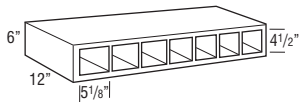
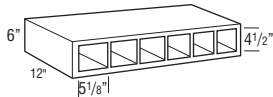
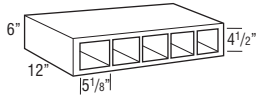

SQWC30 (5 openings)	630	630	630	630	630	630	630	630
----------------------------	-----	-----	-----	-----	-----	-----	-----	-----

SQWC36 (6 openings)	708	708	708	708	708	708	708	708
----------------------------	-----	-----	-----	-----	-----	-----	-----	-----

SQWC42 (7 openings)	787	787	787	787	787	787	787	787
----------------------------	-----	-----	-----	-----	-----	-----	-----	-----

- Hardwood veneer on 3/4" furniture board core.
- Matching interior.
- Frameless construction. Can be used in horizontal or vertical application.

Modifications

ADDTK	AUTH	CBO	CCO	CFNT0	CFRMO	CND	EX	FB	FDRW	FPEB	FTK	FTK_V	FULL/MFO	ID	MI	NSCH	P	RD	RECTKL/R
																			• STD

Construction Upgrades

APU	PEU

Decorative Door Options

CG	MD

Floating Shelves

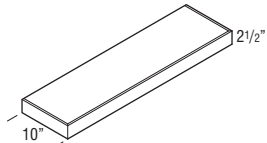

Maximum Weight Capacity per Shelf	
FS24	25 lbs.
FS30	31 lbs.
FS36	37 lbs.
FS42	43 lbs.
FS48	50 lbs.
FS54	56 lbs.
FS60	62 lbs.

FS24	435	435	435	435	435	435	435	435
FS30	538	538	538	538	538	538	538	538
FS36	606	606	606	606	606	606	606	606
FS42	622	622	622	622	622	622	622	622
FS48	684	684	684	684	684	684	684	684
FS54	752	752	752	752	752	752	752	752
FS60	827	827	827	827	827	827	827	827

- 3/4" thick solid-wood front, back and ends. 3/8" thick veneered Medium Density Fiberboard (MDF) top and bottom. When a Paint finish is specified, veneer may not be applied. Front and ends are mitered together.
- Includes wood mounting plate with metal brackets. Once installed, mounting system is fully concealed.
- Not trimmable.

MODIFICATIONS

No modifications available for these products.

Species Availability

Hickory	Maple	Oak	Painted	Rustic Hickory	Laminate
•	•	•	•	Hickory	Painted

Price Point

Wall Organizer

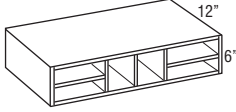
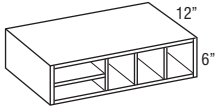
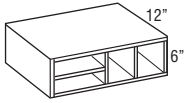

	1	2	3	4	5	6	7	8
W024	536	536	536	536	536	536	536	536
W030	630	630	630	630	630	630	630	630
W036	708	708	708	708	708	708	708	708

- Hardwood veneer on a 3/4" furniture board core.
- Frameless construction.
- Matching interior.

Modifications

ADDTK	AUTH	CBO	CCO	CFNTO	CFRMO	CND	EX	FB	FDRW	FPEB	FTK	FTK_V	FULL/MFO	ID	MI	NSCH	P	RD	RECTKL/R
															STD				

Construction Upgrades

APU	PEU

Decorative Door Options

CG	MD

Designer Square Wood Hood

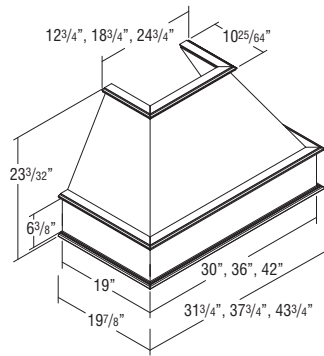

DRH30S	3019	3019	3019	3019	3019	3019	3019	3019
DRH36S	3044	3044	3044	3044	3044	3044	3044	3044
DRH42S	3239	3239	3239	3239	3239	3239	3239	3239

- Freestanding unit (must be properly secured to wall and cannot be attached to adjacent cabinets).
- Chimney available (RHC.). See below.
- Check your local building code for installation heights above the range.
- Powder coated silver metallic metal liner included.
- Liner opening size: 10 1/4" deep by 19 1/2" wide.
- Installation instructions and hardware included.
- When ordering Rustic Hickory, Hickory will be substituted.
- Exhaust system not included. Compatible with all Homecrest blowers.
- No changes or cancellations will be accepted after 24 hours from acknowledgment of order.

MODIFICATIONS
No modifications available for these products.

Designer Wood Hood Chimney

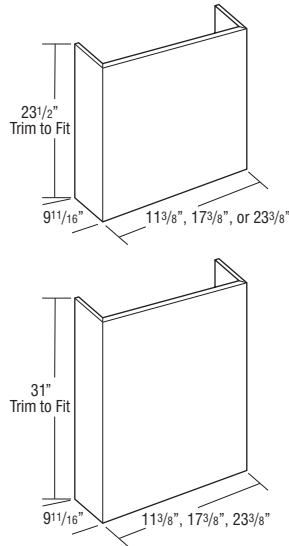

RHC30	491	491	491	491	491	491	491	491
RHC36	511	511	511	511	511	511	511	511
RHC42	579	579	579	579	579	579	579	579



RHCT30	619	619	619	619	619	619	619	619
RHCT36	644	644	644	644	644	644	644	644
RHCT42	730	730	730	730	730	730	730	730

- 3/4" thick plywood.
- Trimmable.
- Optional accessory for Designer Square Wood Hood and Square Flat Panel Wood Hood.
- RHC30 and RHCT30 are not compatible with CONVERSION.
- When ordering Rustic Hickory, Hickory will be substituted.
- No changes or cancellations will be accepted after 24 hours from acknowledgment of order.

MODIFICATIONS
No modifications available for these products.

Tapered Wood Hood

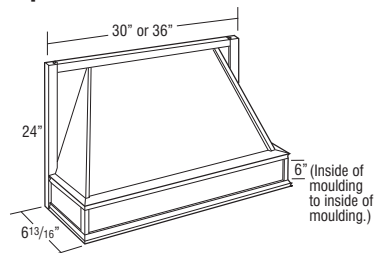

TWH30	1640	1640	1640	1640	1640	1640	1640	1640
TWH36	1724	1724	1724	1724	1724	1724	1724	1724

- Install between adjacent cabinets.
- Check your local building code for installation heights above the range.
- Tapered design.
- Liner opening size: 10 1/4" deep x 19 1/2" wide.
- Silver metallic liner included, not available for order separately.
- When ordering Rustic Hickory, Hickory will be substituted.
- Exhaust system not included. Compatible with all Homecrest blowers.
- No changes or cancellations will be accepted after 24 hours from acknowledgment of order.

MODIFICATIONS
No modifications available for these products.

Square Flat Panel Wood Hood

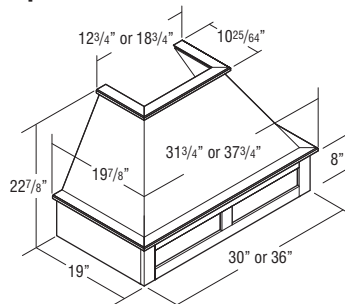

WHSFP30	3623	3623	3623	3623	3623	3623	3623	3623
WHSFP36	3654	3654	3654	3654	3654	3654	3654	3654

- Freestanding unit (must be properly secured to wall and cannot be attached to adjacent cabinets).
- Exhaust system not included. Compatible with all Homecrest blowers.
- Chimney available (RHCT).
- Check local building code and appliance installation specifications for clearance requirements and installation heights above the range.
- Silver metallic liner included. Assembly required.
- Installation instructions and hardware included.
- Liner opening size: 10 1/4" deep by 19 1/2" wide.
- When ordering Rustic Hickory, Hickory will be substituted.
- No changes or cancellations will be accepted after 24 hours from acknowledgment of order.

MODIFICATIONS
No modifications available for these products.

Shiplap Tapered Wood Hood

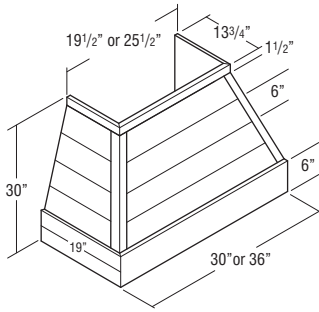

JWHSIPT30	N/A	3560	3560	N/A	N/A	3560	3560	3560
JWHSIPT36	N/A	3975	3975	N/A	N/A	3975	3975	3975

- Freestanding unit (must be properly secured to wall and cannot be attached to adjacent cabinets).
- Constructed of 3/4" thick grooved plywood creating a shiplap appearance.
- Exhaust system not included. Compatible with all Homecrest blowers.
- Compatible with Shiplap Chimney (JWHSIPCH_), which can be trimmed. See below.
- Check local building code and appliance installation specifications for clearance requirements and installation heights above the range.
- Silver metallic liner included. Assembly required.
- Installation instructions and hardware included.
- Liner opening size: 10 1/4" deep by 19 1/2" wide.
- Only available in Maple and Painted Hardwood. Painted Hardwood will be used for PureStyle™.
- No changes or cancellations will be accepted after 24 hours from acknowledgment of order.

MODIFICATIONS
No modifications available for these products.

Shiplap Wood Hood Chimney

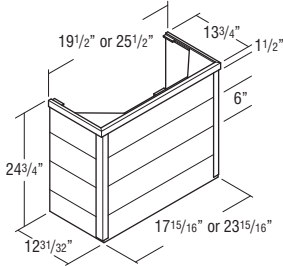

JWHSIPCH30	N/A	1046	1046	N/A	N/A	1046	1046	1046
JWHSIPCH36	N/A	1046	1046	N/A	N/A	1046	1046	1046

- Constructed of 3/4" thick grooved plywood creating a shiplap appearance.
- Trimmable. If trimmed, moulding is recommended to conceal any cut marks.
- Optional accessory for Wood Hood Shiplap Tapered (JWHSIPT_) for an installed height of 54".
- Only available in Maple and Painted Hardwood. Painted Hardwood will be used for PureStyle™.
- No changes or cancellations will be accepted after 24 hours from acknowledgment of order.

MODIFICATIONS
No modifications available for these products.

Simple Tapered Wood Hood

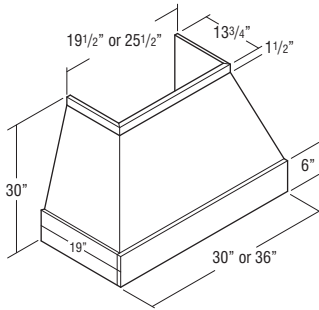

WHSMT30	3560	3560	3560	3560	3560	3560	3560	3560
WHSMT36	3975	3975	3975	3975	3975	3975	3975	3975

- Freestanding unit (must be properly secured to wall and cannot be attached to adjacent cabinets).
- Exhaust system not included. Compatible with all Homecrest blowers.
- Compatible with Simple Wood Hood Chimney (WHSMC_), which can be trimmed. See below.
- Check local building code and appliance installation specifications for clearance requirements and installation heights above the range.
- Silver metallic liner included. Assembly required.
- Installation instructions and hardware included.
- Liner opening size: 10 1/4" deep by 19 1/2" wide.
- Not available in Hickory or Rustic Hickory.
- Glaze finishes not available.
- No changes or cancellations will be accepted after 24 hours from acknowledgment of order.

MODIFICATIONS
No modifications available for these products.

Simple Wood Hood Chimney

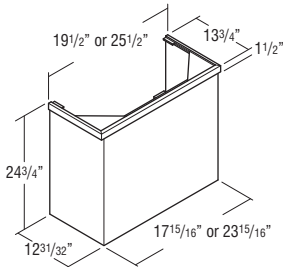

WHSMC30	1046	1046	1046	1046	1046	1046	1046	1046
WHSMC36	1046	1046	1046	1046	1046	1046	1046	1046

- Trimmable. If trimmed, moulding is recommended to conceal any cut marks.
- Optional accessory for Simple Tapered Wood Hoods (WHSMT_) for an installed height of 54".
- Not available in Hickory or Rustic Hickory.
- Glaze finishes not available.
- No changes or cancellations will be accepted after 24 hours from acknowledgment of order.

MODIFICATIONS
No modifications available for these products.

**Canopy Square Wood Hood,
24" High**

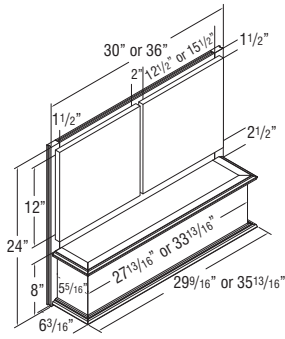

WHCS30	2575	2575	2575	2575	2575	2575	2575	2575
WHCS36	2775	2775	2775	2775	2775	2775	2775	2775

- Operable doors.
- Install between adjacent cabinets.
- Powder coated silver metallic metal liner included.
- Liner opening size: 10 1/4" deep by 19 1/2" wide.
- Check your local building code for installation heights above the range.
- Exhaust system not included. Compatible with all Homecrest blowers.
- No changes or cancellations will be accepted after 24 hours from acknowledgment of order.

Modifications

ADDTK	AUTH	CBO	CCO	CFNT0	CFRMO	CND	EX	FB	FDRW	FPEB	FTK	FTK_V	FULL/MFO	ID	MI	NSCH	P	RD	RECTKL/R	

Construction Upgrades

APU	PEU

Decorative Door Options

CG	MD

**Straight Batten Wood Hood,
24" or 30" High**

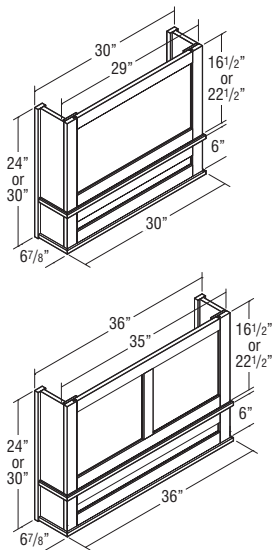

WHSBATTEN3024	2625	2625	2625	2625	2625	2625	2625	2625
WHSBATTEN3030	2928	2928	2928	2928	2928	2928	2928	2928

WHSBATTEN3624	2888	2888	2888	2888	2888	2888	2888	2888
WHSBATTEN3630	3253	3253	3253	3253	3253	3253	3253	3253

- Install between adjacent cabinets.
- Exhaust system not included. Compatible with all Homecrest blowers.
- Check local building code and appliance installation specifications for clearance requirements and installation heights above the range.
- Silver metallic liner included. Assembly required.
- Installation instructions and hardware included.
- Liner opening size: 10 1/4" deep by 19 1/2" wide.
- End rails, side stiles, and center stiles are 2 1/4" wide with a shaker profile.
- Grain runs vertical on center panels in upper section and horizontal on center panel in lower section.
- When ordering Rustic Hickory, Hickory will be substituted.
- No changes or cancellations will be accepted after 24 hours from acknowledgment of order.

MODIFICATIONS

No modifications available for these products.

**Straight Batten Wood Hood,
36" High**

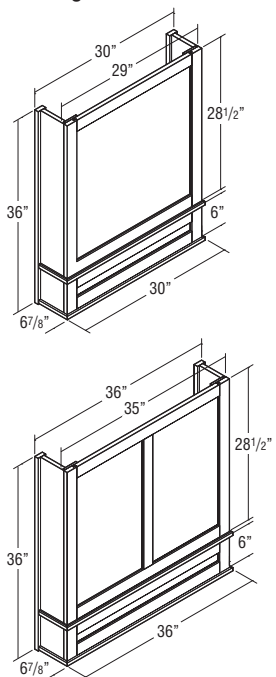

WHSBATTEN3036	3231	3231	3231	3231	3231	3231	3231	3231
----------------------	------	------	------	------	------	------	------	------

WHSBATTEN3636	3618	3618	3618	3618	3618	3618	3618	3618
----------------------	------	------	------	------	------	------	------	------

- Install between adjacent cabinets.
- Exhaust system not included. Compatible with all Homecrest blowers.
- Check local building code and appliance installation specifications for clearance requirements and installation heights above the range.
- Silver metallic liner included. Assembly required.
- Installation instructions and hardware included.
- Liner opening size: 10 1/4" deep by 19 1/2" wide.
- End rails, side stiles, and center stiles are 2 1/4" wide with a shaker profile.
- Grain runs vertical on center panels in upper section and horizontal on center panel in lower section.
- When ordering Rustic Hickory, Hickory will be substituted.
- No changes or cancellations will be accepted after 24 hours from acknowledgment of order.

MODIFICATIONS

No modifications available for these products.

Wood Hood Blower, 600 CFM

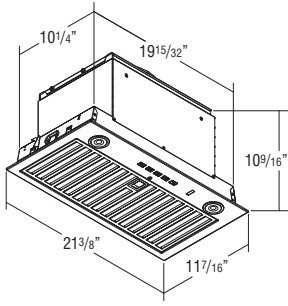

BLOWER600

3056

3056

3056

3056

3056

3056

3056

3056

- 600 CFM.
- Two 3 watt (300+ Lumens, 3 settings) LED lights included.
- Installation instructions, warranty, and repair information included.
- Stainless Steel finish.
- Four speed push button control.
- Includes removable dishwasher safe grease filter.
- WIFI Enabled, Auto-Sensing, and Heat Sentry technology included.
- 1 year warranty.
- Compatible with all Wood Hoods.

MODIFICATIONS

No modifications available for these products.

Wood Hood Blower, 400 CFM

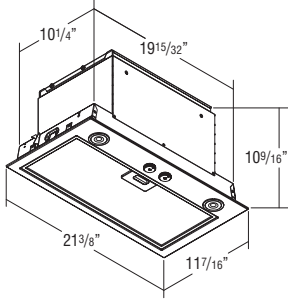

BLOWER400

1568

1568

1568

1568

1568

1568

1568

1568

- 400 CFM.
- Two 2.8 watt (250+ Lumens) LED lights included.
- Installation instructions, warranty, and repair information included.
- Stainless Steel finish.
- Three speed rotary switch control.
- Includes removable dishwasher safe grease filter.
- Heat Sentry technology included.
- 1 year warranty.
- Compatible with all Wood Hoods.

MODIFICATIONS

No modifications available for these products.

Wood Hood Interior Ductwork Conversion Kit

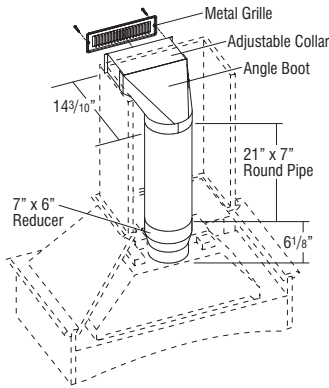

CONVERSION

291

291

291

291

291

291

291

291

FILTERCHAR

150

150

150

150

150

150

150

150

- CONVERSION: Optional kit to allow recirculation of the hood exhaust back into the kitchen.
- CONVERSION includes: (1) 21" x 7" round pipe, (1) adjustable collar, (1) white metal soffit grille (11 3/8" x 3 5/8"), (1) angle boot, (1) 7" x 6" reducer, filter and installation instructions.
- CONVERSION is not compatible with RHC30 or RHCT30.
- FILTERCHAR for use in all Homecrest blowers.
- FILTERCHAR is a replacement charcoal filter used to provide proper filtration for air recirculation when a conversion kit is used. The filter attaches to the inside of the removable mesh metal filter in the blower.

MODIFICATIONS

No modifications available for these products.

BASE CABINET NOMENCLATURE

All Base Cabinets are 34 1/2" high and 24" deep unless otherwise noted.

B24

Cabinet Type ← Cabinet Width

- Heat Shields available for field installation. See page 174.

TOEKICKS

Base Cabinets are shipped with an unfinished toekick. Finished toekicks in matching wood veneer or laminate must be ordered separately and field installed.

MODIFICATIONS

Mod.	Description	Mod.	Description
AUTHB	Authentic Ends Both	FPEB	Furniture Finished Plywood End Panels
AUTHL	Authentic End Left	FTK	Flush Toekick
AUTHR	Authentic End Right	FTKAV	Flush Toekick Arch
CBO	Cabinet Box Only	FTKAV	Flush Toekick Furniture
CCO	Cabinet Case Only	MI	Matching Interior
CFNTO	Cabinet Front Only	NSCH	Non SoftTouch Hinge
CFRMO	Cabinet Frame Only	P	Peninsula
CFP	Cabinet False Panel	RD	Reduced Depth
CND	Cabinet with No Door, with Drawer	RECTKALL	Island Toekick
EXL	Extended Stile Left	RECTKBK	Recessed Toekick Back
EXR	Extended Stile Right	RECTKL	Recessed Toekick Left
FB	Finished Ends	RECTKR	Recessed Toekick Right
FD	Full Depth Shelf	RT	Roll Tray
FDRW	Furniture Board Drawer	VTK	Void Toekick

CONSTRUCTION UPGRADES

Mod.	Description
APU	All-plywood Unfinished
PEU	Plywood Ends Unfinished

MODIFICATIONS GRID KEY

- Available
- STD Standard on these cabinets

90

Base Single Door	Price Point	1	2	3	4	5	6	7	8
		B9 L or R	362	442	478	489	530	542	572
B12 L or R	380	464	504	515	558	571	602	650	
B15 L or R	401	488	527	541	577	600	633	683	
B18 L or R	432	522	559	579	615	644	682	738	
B21 L or R	470	562	595	625	651	691	734	793	
B24 L or R	519	620	662	694	731	777	813	878	

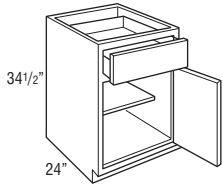

- Adjustable 15" deep shelf.

Modifications

AUTH	CBO	CCO	CFNTO	CFP	CFRMO	CND	EX	FB	FD	FDRW	FPEB	FTK	FTK_V	MI	NSCH	P	RD	RECTKALL	RECTKBK	RECTKL/R	RT	VTK	
•	•	•	•	•	•	•	•	•	•	•	•	•	•*	•	•	•	•	•	•	•	•	•	•

*FTKAV/FTKAV not available on B9 and B12. *P and RT not available on B9.

Construction Upgrades

APU	PEU
•	•

Base Double Door

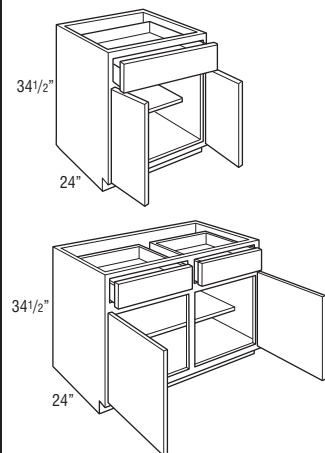

B24B	544	653	698	731	767	818	853	923
B27B	645	771	853	858	941	991	994	1074
B30B	670	796	839	887	1001	1041	1094	1183
B33B	718	843	885	937	1062	1104	1162	1256
B36B	741	880	924	978	1094	1148	1209	1307

B39	750	895	939	999	1112	1199	1262	1364
B42	767	917	964	1019	1143	1221	1288	1394
B45	793	946	995	1053	1184	1269	1337	1447
B48	821	972	1023	1083	1226	1313	1377	1489

- Adjustable 15" deep shelf.

Modifications

AUTH	CBO	CCO	CFNTO	CFP	CFRMO	CND	EX	FB	FD	FDRW	FPEB	FTK	FTK_V	MI	NSCH	P	RD	RECTKALL	RECTKBK	RECTKL/R	RT	VTK
•	•	•	•	•	•	•	•	•	•	•	•	•	•	•	•	•	•	•*	•	•	•	•

*RECTKALL available for B27B-B48.

Construction Upgrades

APU	PEU
•	•

Full Height Base Single Door

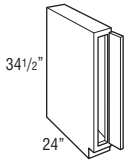

	1	2	3	4	5	6	7	8
B6FH L or R	344	420	454	464	504	516	543	588

- Frame opening is 3" wide.
- Cabinet has a full top panel.
- Utilizes a 5 1/2" wide filler as a hinged door for all overlay styles.
- Waldron PureStyle™ overlays will be painted hardwood.

Modifications

AUTH	CBO	CCO	CFNTO	CFP	CFRMO	CND	EX	FB	FD	FDRW	FPEB	FTK	FTK_V	MI	NSCH	P	RD	RECTKALL	RECTKBK	RECTKL/R	RT	VTK	
		•	•		•		•	•			•	•		•	•		•						•

Construction Upgrades

APU	PEU
•	•

Full Height Base Single Door

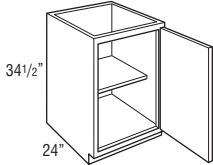

B9FH L or R	362	442	478	489	530	542	572	618
B12FH L or R	380	464	504	515	558	571	602	650
B15FH L or R	401	488	527	541	577	600	633	683
B18FH L or R	432	522	559	579	615	644	682	738
B21FH L or R	470	562	595	625	651	691	734	793
B24FH L or R	519	620	662	694	731	777	813	878

- Adjustable 15" deep shelf.

Modifications

AUTH	CBO	CCO	CFNTO	CFP	CFRMO	CND	EX	FB	FD	FDRW	FPEB	FTK	FTK_V	MI	NSCH	P	RD	RECTKALL	RECTKBK	RECTKL/R	RT	VTK	
•	•	•	•		•		•	•			•	•	•*	•	•	•*	•			•	•	•*	•

*FTKAV/FTKFV not available on B9FH and B12FH. *P and RT not available on B9FH.

Construction Upgrades

APU	PEU
•	•

Full Height Base Double Door

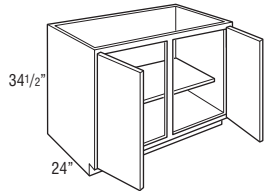
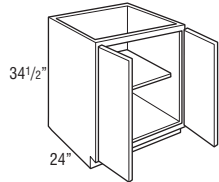

B24BFH	544	653	698	731	767	818	853	923
B27BFH	615	738	795	819	877	930	969	1049
B30BFH	670	796	839	887	1001	1041	1094	1183
B33BFH	718	843	885	937	1062	1104	1162	1256
B36BFH	741	880	924	978	1094	1148	1209	1307

B39FH	750	895	939	999	1112	1199	1262	1364
B42FH	767	917	964	1019	1143	1221	1288	1394
B45FH	793	946	995	1053	1184	1269	1337	1447
B48FH	793	946	995	1053	1184	1269	1337	1447

- Adjustable 15" deep shelf.

Modifications

AUTH	CBO	CCO	CFNTO	CFP	CFRMO	CND	EX	FB	FD	FDRW	FPEB	FTK	FTK_V	MI	NSCH	P	RD	RECTKALL	RECTKBK	RECTKL/R	RT	VTK
•	•	•	•		•		•	•			•	•	•	•	•	•	•	•*	•	•	•	•

*RECTKALL available for B27BFH-B48FH.

Construction Upgrades

APU	PEU
•	•

Base Single Door with Roll Trays

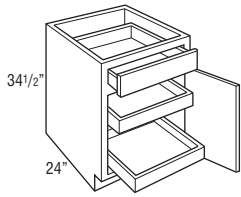

	1	2	3	4	5	6	7	8
B12RT L or R	596	680	720	731	774	787	818	866
B15RT L or R	617	704	743	757	793	816	849	899
B18RT L or R	648	738	775	795	831	860	898	954
B21RT L or R	686	778	811	841	867	907	950	1009
B24RT L or R	735	836	878	910	947	993	1029	1094

- 2 wood roll trays standard.
- Cabinet may accommodate up to 4 roll trays, additional may be purchased separately for field installation. See page 175.

Modifications

AUTH	CBO	CCO	CFNTO	CFP	CFRMO	CND	EX	FB	FD	FDRW	FPEB	FTK	FTK_V	MI	NSCH	P	RD	RECTKALL	RECTKBK	RECTKL/R	RT	VTK	
•	•	•	•	•	•	•	•	•	•	•	•	•	•*	•	•	•	•	•	•	•	•	•	•

*FTKAV/FTKRV not available on B12RT.

Construction Upgrades

APU	PEU
•	•

Base Double Door with Roll Trays

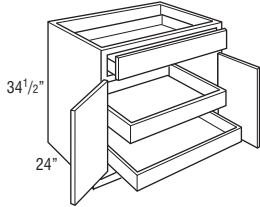

B24BRT	760	869	914	947	983	1034	1069	1139
B27BRT	861	987	1069	1074	1157	1207	1210	1290
B30BRT	886	1012	1055	1103	1217	1257	1310	1399
B33BRT	934	1059	1101	1153	1278	1320	1378	1472
B36BRT	957	1096	1140	1194	1310	1364	1425	1523

- 2 wood roll trays standard.
- Cabinet may accommodate up to 4 roll trays, additional may be purchased separately for field installation. See page 175.

Modifications

AUTH	CBO	CCO	CFNTO	CFP	CFRMO	CND	EX	FB	FD	FDRW	FPEB	FTK	FTK_V	MI	NSCH	P	RD	RECTKALL	RECTKBK	RECTKL/R	RT	VTK	
•	•	•	•	•	•	•	•	•	•	•	•	•	•	•	•	•	•	•*	•	•	•	•	•

*RECTKALL not available on B24BRT.

Construction Upgrades

APU	PEU
•	•

Base Double Door with Roll Trays

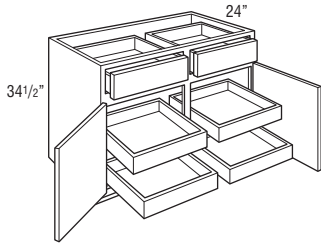

B39RT	1182	1327	1371	1431	1544	1631	1694	1796
B42RT	1199	1349	1396	1451	1575	1653	1720	1826
B45RT	1225	1378	1427	1485	1616	1701	1769	1879
B48RT	1253	1404	1455	1515	1658	1745	1809	1921

- 4 roll trays standard.
- Cabinet may accommodate up to 8 roll trays, additional may be purchased separately for field installation. See page 175.

Modifications

AUTH	CBO	CCO	CFNTO	CFP	CFRMO	CND	EX	FB	FD	FDRW	FPEB	FTK	FTK_V	MI	NSCH	P	RD	RECTKALL	RECTKBK	RECTKL/R	RT	VTK	
•	•	•	•	•	•	•	•	•	•	•	•	•	•	•	•	•	•	•	•	•	•	•	•

Construction Upgrades

APU	PEU
•	•

Base with Roll-out Tray Divider

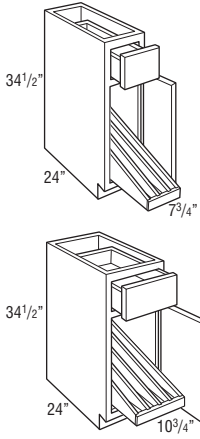

	1	2	3	4	5	6	7	8
B12TDRO L or R	671	755	795	806	849	862	893	941

B15TDRO L or R	725	812	851	865	901	924	957	1007
-----------------------	-----	-----	-----	-----	-----	-----	-----	------

- Tray divider utilizes Softouch undermount guides.
- Dividers are removable.
- 12" - 3 compartments.
- 15" - 4 compartments.

Modifications

AUTH	CBO	CCO	CFNTO	CFP	CFRMO	CND	EX	FB	FD	FDRW	FPEB	FTK	FTK_V	MI	NSCH	P	RD	RECTKALL	RECTKBK	RECTKL/R	RT	VTK	
•	•	•	•	•	•	•	•	•	•	•	•	•	•*	•	•	•	•	•	•	•	•	•	•

*FTKAV/FTKFV not available on B12TDRO.

Construction Upgrades

APU	PEU
•	•

Base with Tray Divider

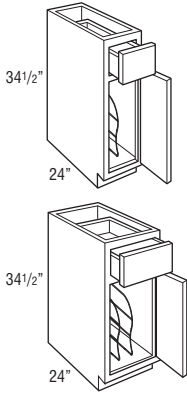

TD9 L or R	408	488	524	535	576	588	618	664
-------------------	-----	-----	-----	-----	-----	-----	-----	-----

TD12 L or R	472	556	596	607	650	663	694	742
--------------------	-----	-----	-----	-----	-----	-----	-----	-----

TD15 L or R	493	580	619	633	669	692	725	775
--------------------	-----	-----	-----	-----	-----	-----	-----	-----

- Tray Divider is chrome.
- Tray Divider is also available as an accessory for field installation. See page 174.

Modifications

AUTH	CBO	CCO	CFNTO	CFP	CFRMO	CND	EX	FB	FD	FDRW	FPEB	FTK	FTK_V	MI	NSCH	P	RD	RECTKALL	RECTKBK	RECTKL/R	RT	VTK	
•	•	•	•	•	•	•	•	•	•	•	•	•	•*	•	•	•	•	•	•	•	•	•	•

*FTKAV/FTKFV not available on TD9 and TD12.

Construction Upgrades

APU	PEU
•	•

Full Height Base with Tray Divider

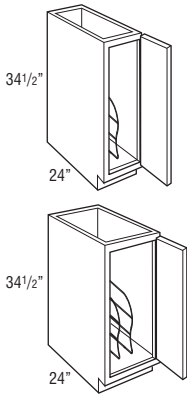

TD9FH L or R	408	488	524	535	576	588	618	664
---------------------	-----	-----	-----	-----	-----	-----	-----	-----

TD12FH L or R	472	556	596	607	650	663	694	742
----------------------	-----	-----	-----	-----	-----	-----	-----	-----

TD15FH L or R	493	580	619	633	669	692	725	775
----------------------	-----	-----	-----	-----	-----	-----	-----	-----

- Tray Divider is chrome.
- Tray Divider is also available as an accessory for field installation. See page 174.

Modifications

AUTH	CBO	CCO	CFNTO	CFP	CFRMO	CND	EX	FB	FD	FDRW	FPEB	FTK	FTK_V	MI	NSCH	P	RD	RECTKALL	RECTKBK	RECTKL/R	RT	VTK	
•	•	•	•	•	•	•	•	•	•	•	•	•	•*	•	•	•	•	•	•	•	•	•	•

*FTKAV/FTKFV not available on TD9FH and TD12FH.

Construction Upgrades

APU	PEU
•	•

Sink Base, Single Door

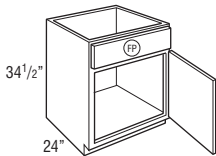

SB21 L or R	435	507	543	565	599	618	647	700
--------------------	-----	-----	-----	-----	-----	-----	-----	-----

SB24 L or R	458	534	572	595	630	650	681	737
--------------------	-----	-----	-----	-----	-----	-----	-----	-----

Modifications

AUTH	CBO	CCO	CFNTO	CFP	CFRMO	CND	EX	FB	FD	FDRW	FPEB	FTK	FTK_V	MI	NSCH	P	RD	RECTKALL	RECTKBK	RECTKL/R	RT	VTK	
•	•	•	•	•	•	•	•	•	•	•	•	•	•	•	•	•	•	•	•	•	•	•	•

Construction Upgrades

APU	PEU
•	•

Sink Base

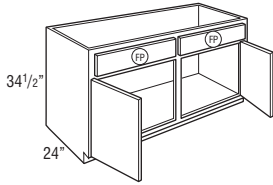
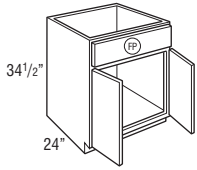

SB24B	481	562	603	625	662	685	717	775
SB27B	523	627	673	697	753	788	825	892
SB30B	527	631	679	704	755	796	842	908
SB33B	542	661	720	734	793	849	895	969
SB36B	571	689	764	768	842	901	951	1027
<hr/>								
SB39	597	702	766	780	849	903	954	1034
SB42	635	739	793	821	875	934	983	1062
SB45	660	769	822	853	910	972	1028	1111
SB48	673	797	857	885	942	1021	1070	1157

Modifications

AUTH	CBO	CCO	CFNTO	CFP	CFRMO	CND	EX	FB	FD	FDRW	FPEB	FTK	FTK_V	MI	NSCH	P	RD	RECTKALL	RECTKBK	RECTKL/R	RT	VTK
•	•	•	•	STD	•	•	•	•	•	•	•	•	•	•	•	•	•	•*	•	•	•	•

*RECTKALL available for SB27B-SB48.

Construction Upgrades

APU	PEU
•	•

Sink Base with CabMat™

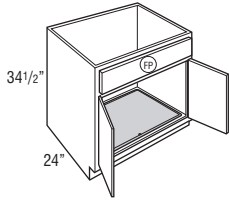

SB30BCM	735	839	887	912	963	1004	1050	1116
SB33BCM	750	869	928	942	1001	1057	1103	1177
SB36BCM	779	897	972	976	1050	1109	1159	1235

• CabMat™ is designed to capture spills and is removable for cleaning.

Modifications

AUTH	CBO	CCO	CFNTO	CFP	CFRMO	CND	EX	FB	FD	FDRW	FPEB	FTK	FTK_V	MI	NSCH	P	RD	RECTKALL	RECTKBK	RECTKL/R	RT	VTK
•	•	•	•	STD	•	•	•	•	•	•	•	•	•	•	•	•	•	•	•	•	•	•

Construction Upgrades

APU	PEU
•	•

Sink Base, 27" Deep

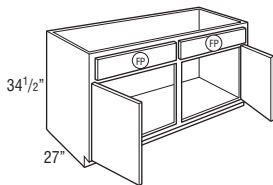
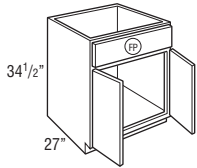

SB243427B	631	712	753	775	812	835	867	925
SB273427B	673	777	823	847	903	938	975	1042
SB303427B	677	781	829	854	905	946	992	1058
SB333427B	692	811	870	884	943	999	1045	1119
SB363427B	721	839	914	918	992	1051	1101	1177
<hr/>								
SB393427	747	852	916	930	999	1053	1104	1184
SB423427	785	889	943	971	1025	1084	1133	1212
SB453427	810	919	972	1003	1060	1122	1178	1261
SB483427	823	947	1007	1035	1092	1171	1220	1307

Modifications

AUTH	CBO	CCO	CFNTO	CFP	CFRMO	CND	EX	FB	FD	FDRW	FPEB	FTK	FTK_V	MI	NSCH	P	RD	RECTKALL	RECTKBK	RECTKL/R	RT	VTK
•	•	•	•	STD	•	•	•	•	•	•	•	•	•	•	•	•	•	•*	•	•	•	•

*RECTKALL not available on SB243427B.

Construction Upgrades

APU	PEU
•	•

Price
Point

Sink Base with Tilt-out Trays

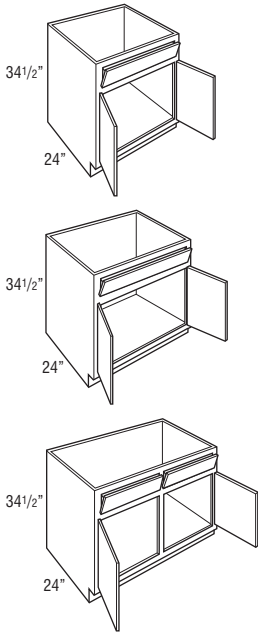

	1	2	3	4	5	6	7	8
SB24BST	575	656	697	719	756	779	811	869
SB27BST	617	721	767	791	847	882	919	986
SB30BST	621	725	773	798	849	890	936	1002
SB33BST	636	755	814	828	887	943	989	1063
SB36BST	669	787	862	866	940	999	1049	1125
SB39ST	695	800	864	878	947	1001	1052	1132
SB42ST	733	837	891	919	973	1032	1081	1160
SB45ST	758	867	920	951	1008	1070	1126	1209

- Tilt-out trays are stain resistant, moisture resistant plastic to allow storage of sponges and other cleaning materials.
- Includes two tilt-out trays on 30"-45" wide.

Modifications

AUTH	CBO	CCO	CFNTO	CFP	CFRMO	CND	EX	FB	FD	FDRW	FPEB	FTK	FTK_V	MI	NSCH	P	RD	RECTKALL	RECTKBK	RECTKL/R	RT	VTK	
•		•				•	•	•			•	•	•	•	•			•	•*		•		•

*RECTKALL not available on SB24ST.

Construction Upgrades

APU	PEU
•	•

Sink Base with Tilt-out Trays and CabMat™

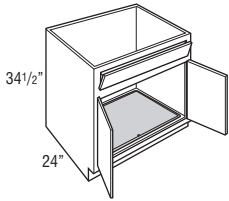

SB30BSTCM	829	933	981	1006	1057	1098	1144	1210
SB33BSTCM	844	963	1022	1036	1095	1151	1197	1271
SB36BSTCM	877	995	1070	1074	1148	1207	1257	1333

- CabMat™ is designed to capture spills and is removable for cleaning.
- Tilt-out trays are stain resistant, moisture resistant plastic to allow storage of sponges and other cleaning materials.
- Includes two tilt-out trays.

Modifications

AUTH	CBO	CCO	CFNTO	CFP	CFRMO	CND	EX	FB	FD	FDRW	FPEB	FTK	FTK_V	MI	NSCH	P	RD	RECTKALL	RECTKBK	RECTKL/R	RT	VTK	
•	•	•				•	•	•			•	•	•	•	•			•	•		•		•

Construction Upgrades

APU	PEU
•	•

Sink Base with Tilt-Out Trays, 27" Deep

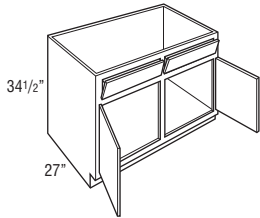
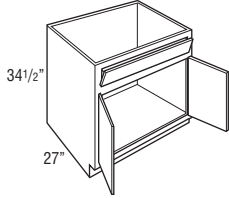
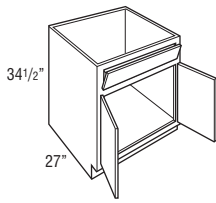

	1	2	3	4	5	6	7	8
SB243427BST	725	806	847	869	906	929	961	1019
SB273427BST	767	871	917	941	997	1032	1069	1136
SB303427BST	771	875	923	948	999	1040	1086	1152
SB333427BST	786	905	964	978	1037	1093	1139	1213
SB363427BST	819	937	1012	1016	1090	1149	1199	1275
SB393427ST	845	950	1014	1028	1097	1151	1202	1282
SB423427ST	883	987	1041	1069	1123	1182	1231	1310
SB453427ST	908	1017	1070	1101	1158	1220	1276	1359

- Tilt-out trays are stain resistant, moisture resistant plastic to allow storage of sponges and other cleaning materials.
- Includes two tilt-out trays on 30"-45" wide.

Modifications

AUTH	CBO	CCO	CFNTD	CFP	CFRMO	CND	EX	FB	FD	FDRW	FPEB	FTK	FTK_V	MI	NSCH	P	RD	RECTKALL	RECTKBK	RECTKL/R	RT	VTK
		•			•	•	•	•			•	•	•	•	•			•*	•	•		•

*RECTKALL not available on SB243427BST.

Construction Upgrades

APU	PEU
•	•

Country Sink Base

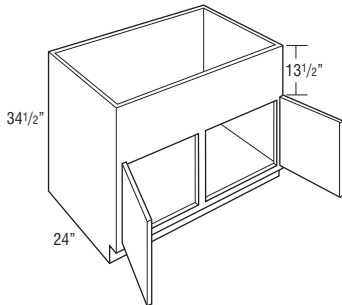
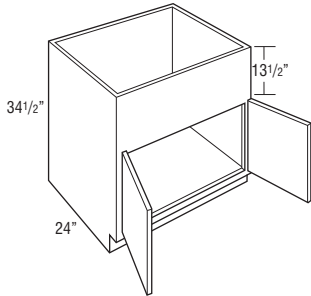

CNTYSB30B	758	858	908	931	977	1021	1061	1147
CNTYSB33B	774	887	945	960	1018	1070	1115	1207
CNTYSB36B	801	914	990	993	1061	1120	1168	1262
CNTYSB39	846	947	1014	1028	1097	1150	1196	1292
CNTYSB42	882	986	1041	1069	1122	1181	1230	1332
CNTYSB48	920	1045	1106	1133	1190	1268	1317	1425

- 13 1/2" panel can be trimmed up to 12".
- For apron front sinks requiring a cut-out height of 6 1/2" or less, see Base Drop-in Range Cabinets on page 99.
- Refer to sink manufacturer's recommendations for additional support required for apron front sinks.

Modifications

AUTH	CBO	CCO	CFNTD	CFP	CFRMO	CND	EX	FB	FD	FDRW	FPEB	FTK	FTK_V	MI	NSCH	P	RD	RECTKALL	RECTKBK	RECTKL/R	RT	VTK
•	•	•	•	•	•	•	•	•	•	•	•	•	•	•	•	•	•	•	•	•	•	•

Construction Upgrades

APU	PEU
•	•

Country Sink Base with CabMat™

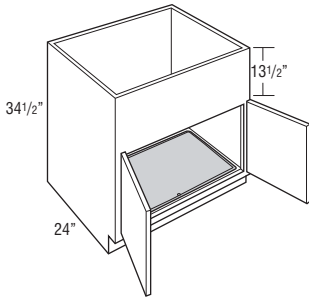

Price Point	1	2	3	4	5	6	7	8
CNTYSB30BCM	966	1066	1116	1139	1185	1229	1269	1355
CNTYSB33BCM	982	1095	1153	1168	1226	1278	1323	1415
CNTYSB36BCM	1009	1122	1198	1201	1269	1328	1376	1470

- CabMat™ is designed to capture spills and is removable for cleaning.
- 13 1/2" panel can be trimmed to 12".
- For apron front sinks requiring a cut-out height of 6 1/2" or less, see Base Drop-in Range Cabinets on page 99.
- Refer to sink manufacturer's recommendations for additional support required for apron front sinks.

Modifications

AUTH	CBO	CCO	CFNTO	CFP	CFRMO	CND	EX	FB	FD	FDRW	FPEB	FTK	FTK_V	MI	NSCH	P	RD	RECTKALL	RECTKBK	RECTKL/R	RT	VTK	
•	•	•	•	•	•	•	•	•	•	•	•	•	•	•	•	•	•	•	•	•	•	•	•

Construction Upgrades

APU	PEU
•	•

Country Sink Base, 27" Deep

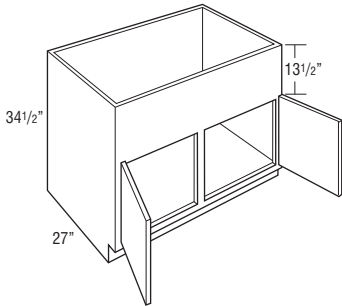
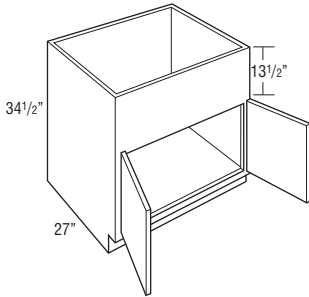

CNTYSB303427B	908	1008	1058	1081	1127	1171	1211	1297
CNTYSB333427B	924	1037	1095	1110	1168	1220	1265	1357
CNTYSB363427B	951	1064	1140	1143	1211	1270	1318	1412

CNTYSB393427	996	1097	1164	1178	1247	1300	1346	1442
CNTYSB423427	1032	1136	1191	1219	1272	1331	1380	1482
CNTYSB483427	1070	1195	1256	1283	1340	1418	1467	1575

- 13 1/2" panel can be trimmed up to 12".
- For apron front sinks requiring a cut-out height of 6 1/2" or less, see Base Drop-in Range Cabinets on page 99.
- Refer to sink manufacturer's recommendations for additional support required for apron front sinks.

Modifications

AUTH	CBO	CCO	CFNTO	CFP	CFRMO	CND	EX	FB	FD	FDRW	FPEB	FTK	FTK_V	MI	NSCH	P	RD	RECTKALL	RECTKBK	RECTKL/R	RT	VTK	
			•	•	•	•	•	•	•	•	•	•	•	•	•	•	•	•	•	•	•	•	•

Construction Upgrades

APU	PEU
•	•

Sink Base SuperCabinet™ with Tilt-out Trays and CabMat™

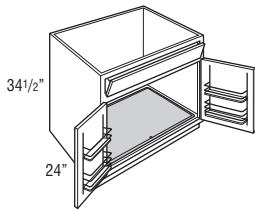

SB36STSCM

1314	1426	1499	1504	1572	1632	1678	1798
------	------	------	------	------	------	------	------

- CabMat™ is designed to capture spills and is removable for cleaning.
- Both doors will have a chrome and wood two-tiered rack.
- Racks on doors are 3 1/4" deep.
- Includes two tilt-out trays.
- Tilt-out trays are stain resistant, moisture resistant plastic to allow storage of sponges and other cleaning materials.

Modifications

AUTH	CBO	CCO	CFNTO	CFP	CFRMO	CND	EX	FB	FD	FDRW	FPEB	FTK	FTK_V	MI	NSCH	P	RD	RECTKALL	RECTKBK	RECTKL/R	RT	VTK
•	•	•			•	•	•	•			•	•	•	•				•	•	•		•

Construction Upgrades

APU	PEU
•	•

Sink Base SuperCabinet™ with Tilt-out Trays

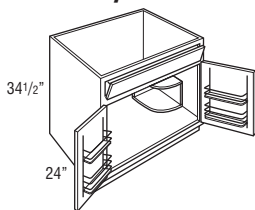

SB36STS

1106	1218	1291	1296	1364	1424	1470	1590
------	------	------	------	------	------	------	------

- Quarter Round Reversible Shelf for left or right applications. (Shelf shipped secure, can be positioned in left or right corner.)
- Both doors will have a chrome and wood two-tiered rack.
- Racks on doors are 3 1/4" deep.
- Includes two tilt-out trays.
- Tilt-out trays are stain resistant, moisture resistant plastic to allow storage of sponges and other cleaning materials.

Modifications

AUTH	CBO	CCO	CFNTO	CFP	CFRMO	CND	EX	FB	FD	FDRW	FPEB	FTK	FTK_V	MI	NSCH	P	RD	RECTKALL	RECTKBK	RECTKL/R	RT	VTK
•		•			•	•	•				•	•	•	•				•	•	•		•

Construction Upgrades

APU	PEU
•	•

Base Built-in Microwave Cabinet with Drawer

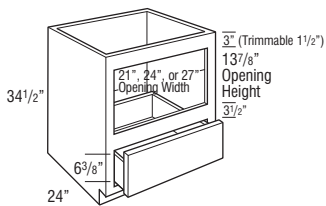

Model	Opening Width	Maximum Width	Opening Height	Maximum Height
BBMWD24	21"	22 1/2"	13 7/8"	16 7/8"
BBMWD27	24"	25 1/2"	13 7/8"	16 7/8"
BBMWD30	27"	28 1/2"	13 7/8"	16 7/8"

BBMWD24

806	829	843	859	865	882	896	942
-----	-----	-----	-----	-----	-----	-----	-----

BBMWD27

914	936	953	972	979	996	1014	1065
-----	-----	-----	-----	-----	-----	------	------

BBMWD30

989	1016	1035	1052	1062	1080	1101	1157
-----	------	------	------	------	------	------	------

- Standard interior.
- Oven Installation Kit included for 24" deep cabinets and has a 400 lb. weight limit.
- The usable cabinet face height between top of drawer front and top of cabinet is 19 1/8" for traditional overlay and 19 3/4" for full/modified full overlay. Be sure to verify overall appliance height, gap requirements, and cut-out dimensions with cabinet specifications.

Modifications

AUTH	CBO	CCO	CFNTO	CFP	CFRMO	CND	EX	FB	FD	FDRW	FPEB	FTK	FTK_V	MI	NSCH	P	RD	RECTKALL	RECTKBK	RECTKL/R	RT	VTK
•	•	•			•		•	•				•	•	•				•	•*	•	•	•

*RECTKALL not available on BBMWD24.

Construction Upgrades

APU	PEU
•	•

Base Microwave Cabinet with Drawer

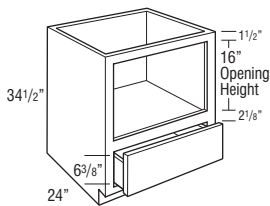

Model	Opening Width	Maximum Width	Opening Height	Maximum Height
BMWD24	21"	22 1/2"	16"	16"
BMWD27	24"	25 1/2"	16"	16"
BMWD30	27"	28 1/2"	16"	16"

BMWD24

711	734	748	764	770	787	801	847
-----	-----	-----	-----	-----	-----	-----	-----

BMWD27

814	836	853	872	879	896	914	965
-----	-----	-----	-----	-----	-----	-----	-----

BMWD30

884	911	930	947	957	975	996	1052
-----	-----	-----	-----	-----	-----	-----	------

- Cabinet interior finished to match cabinet face frame.

Modifications

AUTH	CBO	CCO	CFNTO	CFP	CFRMO	CND	EX	FB	FD	FDRW	FPEB	FTK	FTK_V	MI	NSCH	P	RD	RECTKALL	RECTKBK	RECTKL/R	RT	VTK
•	•	•			•		•					•	•	•	STD			•*	•*	•	•	•

*RD to 18" available. *RECTKALL not available on BMWD24.

Construction Upgrades

APU	PEU

Base Microwave Cabinet with Standard Drawer

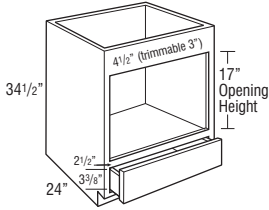

Model	Opening Width	Maximum Width	Opening Height	Maximum Height
BMWSD24	21"	22 1/2"	17"	20"
BMWSD27	24"	25 1/2"	17"	20"
BMWSD30	27"	28 1/2"	17"	20"

Price Point

	1	2	3	4	5	6	7	8
BMWSD24	711	734	748	764	770	787	801	847
BMWSD27	814	836	853	872	879	896	914	965
BMWSD30	884	911	930	947	957	975	996	1052

• Cabinet interior finished to match cabinet face frame.

Modifications

AUTH	CBO	CCO	CFNTO	CFP	CFRMO	CND	EX	FB	FD	FDRW	FPEB	FTK	FTK_V	MI	NSCH	P	RD	RECTKALL	RECTKBK	RECTKL/R	RT	VTK
•	•	•			•		•			•	•	•	•	•	•	•	•*	•*	•	•		•

*RD to 18" available. *RECTKALL not available on BMWSD24.

Construction Upgrades

APU	PEU

Base Drop-in Range Cabinet

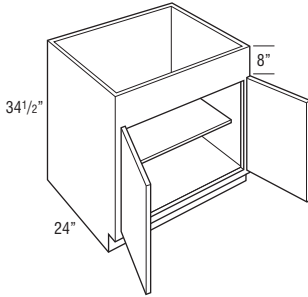

B36BDR	801	914	990	993	1061	1120	1168	1262
---------------	-----	-----	-----	-----	------	------	------	------

- 8" panel can be trimmed up to 6 1/2".
- Adjustable 15" deep shelf.
- Can also be used with apron front sinks, refer to manufacturer's dimension requirements.

Modifications

AUTH	CBO	CCO	CFNTO	CFP	CFRMO	CND	EX	FB	FD	FDRW	FPEB	FTK	FTK_V	MI	NSCH	P	RD	RECTKALL	RECTKBK	RECTKL/R	RT	VTK
•	•	•	•			•	•	•			•	•	•	•	•	•	•	•	•	•	•	•

Construction Upgrades

APU	PEU
•	•

Base Oven Cabinet

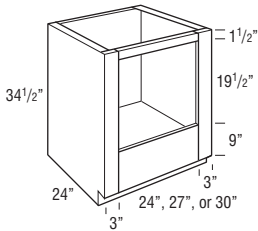

Model	Opening Width	Maximum Width	Opening Height	Maximum Height*
B030	24"	28 1/2"	19 1/2"	27 1/2"
B033	27"	31 1/2"	19 1/2"	27 1/2"
B036	30"	34 1/2"	19 1/2"	27 1/2"

*Top frame cross rail can be removed during field installation if cabinet is properly installed between two adjacent cabinets, increasing the maximum height to 28 1/4".

B030	607	625	637	649	655	670	681	720
B033	618	637	649	664	670	681	697	735
B036	649	669	681	697	704	715	732	772

- Oven cabinet has laminated interior.
- May not hold cooktop and slide-in oven combination. Refer to cooktop and slide-in oven manufacturer specifications.
- Oven Installation Kit included for 24" deep cabinets and has a 400 lb. weight limit.
- Heat shield sold separately.

Modifications

AUTH	CBO	CCO	CFNTO	CFP	CFRMO	CND	EX	FB	FD	FDRW	FPEB	FTK	FTK_V	MI	NSCH	P	RD	RECTKALL	RECTKBK	RECTKL/R	RT	VTK
•					•		•	•			•	•	•	•	•	•	•*	•	•	•	•	•

*RD to 18" and 21" available.

Construction Upgrades

APU	PEU
•	•

Corner Diagonal Sink Base

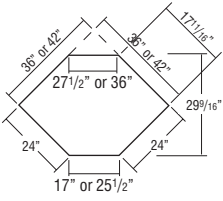
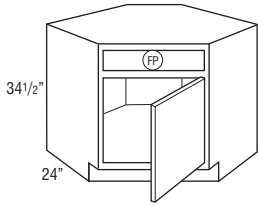

Max. Sink Widths if cut-out is 4" back from face of front frame

CDSB36 L or R	1195	1291	1397	1439	1535	1621	1709	1849
CDSB42†	1470	1593	1723	1774	1895	1996	2105	2277

- Edges beveled at 45°.
 - For sufficient dishwasher door clearance and loading/unloading space, a 15" wide base cabinet is recommended for use between a corner sink base and dishwasher.
 - On CDSB36, to allow for proper door clearance of adjacent cabinets, all door styles regardless of overlay utilize 14 1/2" wide doors with a traditional overlay hinge.
- †CDSB42 has butt doors with no center stile.

Wall Width	Frame	Maximum Sink Width	Maximum Sink Depth
36" x 36"	17"	25 3/4"	27 11/32"
42" x 42"	25 1/2"	34 1/4"	27 11/32"

Modifications

AUTH	CBO	CCO	CFNTD	CFP	CFRMO	CND	EX	FB	FD	FDRW	FPEB	FTK	FTK_V	MI	NSCH	P	RD	RECTKALL	RECTKBK	RECTKL/R	RT	VTK	
				•	•	•	•	•			•												•

Construction Upgrades

APU	PEU
•	•

Corner Sink Front

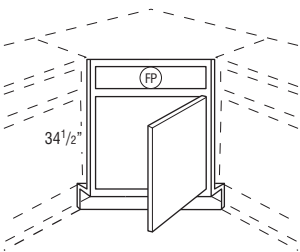

Max. Sink Widths if cut-out is 4" back from face of front frame

CSF36 L or R	347	395	422	440	466	483	513	556
CSF42†	390	460	472	509	518	555	587	635

- Edges beveled at 45°.
 - Corner sink front bottom required for field installation. Order separately. See next item.
 - On CSF36, to allow for proper door clearance of adjacent cabinets, all door styles regardless of overlay utilize 14 1/2" wide doors with a traditional overlay hinge.
- †CSF42 has butt doors with no center stile.

Wall Width	Frame	Maximum Sink Width	Maximum Sink Depth
36" x 36"	17"	25 3/4"	27 11/32"
42" x 42"	25 1/2"	34 1/4"	27 11/32"

Modifications

AUTH	CBO	CCO	CFNTD	CFP	CFRMO	CND	EX	FB	FD	FDRW	FPEB	FTK	FTK_V	MI	NSCH	P	RD	RECTKALL	RECTKBK	RECTKL/R	RT	VTK	
				STD	STD	•	•																

Construction Upgrades

APU	PEU

Angled Corner Sink Front Bottom

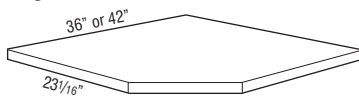

ACSF36	132	132	132	132	132	132	132	132
ACSF42	136	136	136	136	136	136	136	136

- Designed for use with Corner Sink Front.
- 3/8" thick.

MODIFICATIONS

No modifications available for these products.

Construction Upgrades

APU	PEU
•†	

†APU sink front bottoms will be natural maple.

Base Corner Cabinets

- BCs use the wall space the nomenclature implies and may be pulled up to 3" to accommodate odd dimensions in a kitchen.
- Remember to use 3" filler on adjoining cabinets.
- The adjoining run of cabinets will cover the void.
- The L or R in the cabinet nomenclature indicates the location of the void to ensure clearance.
- It is not recommended to place BC cabinets next to appliances where any face component is deeper than 27".

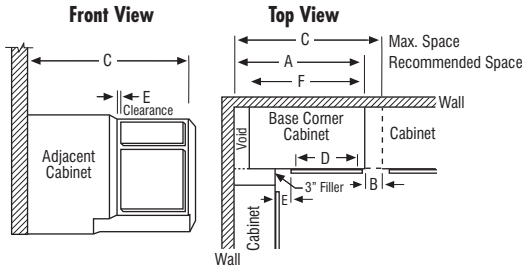

Model	A Recommended Space	B Max. Pull*	C Max. Space	D Face Frame Opening	E* Full/Modified Full Overlay At Min.**	E Traditional Overlay At Max.	F Actual Cabinet	Full/Modified Full Overlay Door Width	Traditional Overlay Door Width
BC3639	36"	6"	42"	7 1/2"	1 3/4"	7 3/4"	27"	10"	8 1/2"
BC3942	39"	4 1/2"	43 1/2"	9"	3 1/4"	7 3/4"	30"	11 1/2"	10"
BC4245	42"	6"	48"	13 1/2"	1 3/4"	7 3/4"	39"	16"	14 1/2"
BC4548	45"	4 1/2"	49 1/2"	15"	3 1/4"	7 3/4"	42"	17 1/2"	16"
BC4851	48"	3"	51"	16 1/2"	4 3/4"	7 3/4"	45"	19"	17 1/2"

*Minimum/maximum space between inside edge of door and face of filler/adjoining cabinet. If cabinet is pulled to maximum stated dimension, filler will need to be cleated for proper attachment.
**When using hardware on cabinet doors/drawers, additional clearance may be needed.

Base Corner

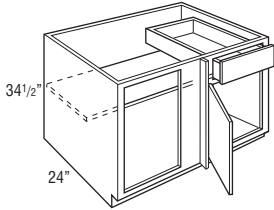

	Price Point	1	2	3	4	5	6	7	8
BC3639 L or R		506	607	640	675	703	744	780	845
BC3942 L or R		547	645	690	717	758	799	844	912
BC4245 L or R		583	683	742	758	817	876	921	996
BC4548 L or R		630	738	803	819	883	941	995	1076
BC4851 L or R		681	792	849	879	934	1013	1063	1150

- L or R indicates void. L (left) void shown.
- Adjustable 15" deep shelf.
- Includes one 3" filler, shipped unattached.
- Nomenclature refers to wall space occupied when installed at minimum and maximum.

Modifications

AUTH	CBO	CCO	CFNTO	CFP	CFRMO	CND	EX	FB	FD	FDRW	FPEB	FTK	FTK_V	MI	NSCH	P	RD	RECTKALL	RECTKBK	RECTKL/R	RT	VTK	
•	•	•	•	•	•	•	•	•	•	•	•	•	•	•	•	•	•	•	•	•	•	•	•

Construction Upgrades

APU	PEU
•	•

Base Lazy Susan Corner with Full Height Door and Lazy Susan (with Center Hinge Door)

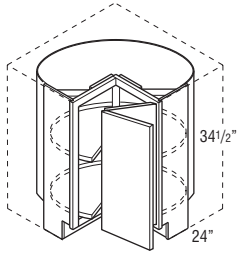

BLS36 L or R

833

912

982

1016

1084

1166

1226

1326

- Cabinet is drum-shaped; adjoining cabinets create sides.
- BLS white plastic shelves are 28" diameter with a chrome pole.
- Drum diameter is 31 1/8" and composed of 1/8" thick hardboard.
- Decorative hardware screws must be countersunk to prevent scratching of adjacent cabinets and face frame of BLS.
- Not recommended for use next to an appliance deeper than standard cabinet depth.

Modifications

AUTH	CBO	CCO	CFNTD	CFP	CFRMO	CND	EX	FB	FD	FDRW	FPEB	FTK	FTK_V	MI	NSCH	P	RD	RECTKALL	RECTKBK	RECTKL/R	RT	VTK	
		•													STD								

Construction Upgrades

APU	PEU

Corner Diagonal Base

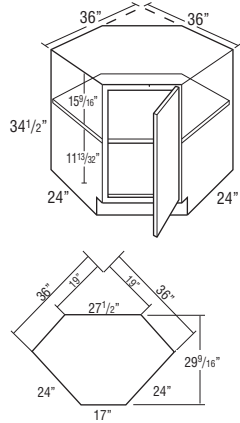

CDB36 L or R

936

1013

1094

1127

1205

1271

1340

1450

- To allow for proper door clearance of adjacent cabinets, all door styles regardless of overlay utilize 14 1/2" wide doors with a traditional overlay hinge.
- One fixed 1/2" thick shelf.

Modifications

AUTH	CBO	CCO	CFNTD	CFP	CFRMO	CND	EX	FB	FD	FDRW	FPEB	FTK	FTK_V	MI	NSCH	P	RD	RECTKALL	RECTKBK	RECTKL/R	RT	VTK	
		•	•	•		•		•			•				•								•

Construction Upgrades

APU	PEU
•	•

Due to fixed shelf mounting, shelves cannot be retrofitted.

Corner Diagonal Base with Full Height Door & Wood Shelves

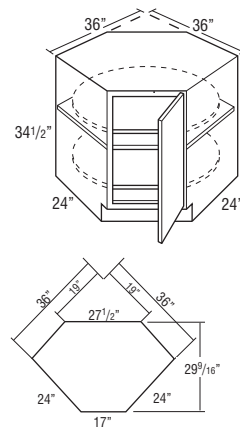

CDB36SS L or R

1782

1911

1928

2104

2121

2149

2248

2432

- To allow for proper door clearance of adjacent cabinets, all door styles regardless of overlay utilize 14 1/2" wide doors with a traditional overlay hinge.
- Features two 28" diameter D-shaped plywood revolving shelves. Lower shelf is mounted to floor. Upper shelf is mounted to fixed shelf. Fixed shelf is 1/2" thick laminated furniture board.

Modifications

AUTH	CBO	CCO	CFNTD	CFP	CFRMO	CND	EX	FB	FD	FDRW	FPEB	FTK	FTK_V	MI	NSCH	P	RD	RECTKALL	RECTKBK	RECTKL/R	RT	VTK	
		•	•		•			•			•				•								•

Construction Upgrades

APU	PEU
•	•

Due to fixed shelf mounting, shelves cannot be retrofitted.

Base Easy Reach

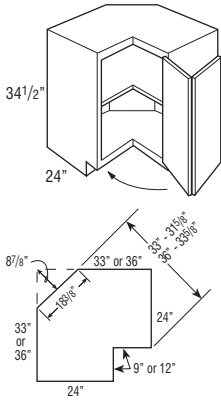

Due to fixed shelf mounting, shelves cannot be retrofitted.

BER33 L or R	885	967	1041	1071	1148	1208	1271	1374
BER36 L or R	936	1013	1094	1127	1205	1271	1340	1450

- Decorative hardware screws must be countersunk to prevent scratching of adjacent cabinets and face frame of BER.
- Fixed shelf is 1/2" thick laminated furniture board.
- Not recommended for use next to an appliance deeper than standard cabinet depth.

Modifications

AUTH	CBO	CCO	CFNTO	CFP	CFRMO	CND	EX	FB	FD	FDRW	FPEB	FTK	FTK_V	MI	NSCH	P	RD	RECTKALL	RECTKBK	RECTKL/R	RT	VTK
	•	•						•			•				STD							•

Construction Upgrades

APU	PEU
•	•

Asymmetrical Base Easy Reach

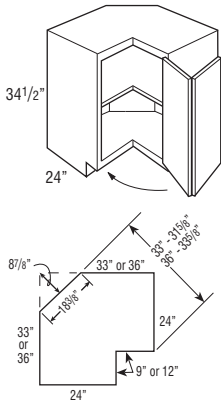

Due to fixed shelf mounting, shelves cannot be retrofitted.

BER3336 L or R	936	1013	1094	1127	1205	1271	1340	1450
BER3633 L or R	936	1013	1094	1127	1205	1271	1340	1450

- BER3336 L or R wall width is 33" x 36".
- BER3633 L or R wall width is 36" x 33".
- Legs at the front frames are 9" on 33" and 12" on 36" leg.
- Nomenclature for asymmetrical cabinets reads as follows:
First set of numbers = left side of cabinet dimensions.
Second set of numbers = right side of cabinet dimensions.
- Decorative hardware screws must be countersunk to prevent scratching of adjacent cabinets and face frame of BER.
- Fixed shelf is 1/2" thick laminated furniture board.
- Not recommended for use next to an appliance deeper than standard cabinet depth.

Modifications

AUTH	CBO	CCO	CFNTO	CFP	CFRMO	CND	EX	FB	FD	FDRW	FPEB	FTK	FTK_V	MI	NSCH	P	RD	RECTKALL	RECTKBK	RECTKL/R	RT	VTK
	•	•						•			•				STD							•

Construction Upgrades

APU	PEU
•	•

Base Corner Super Susan with Wood Shelves

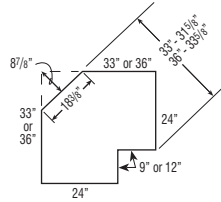
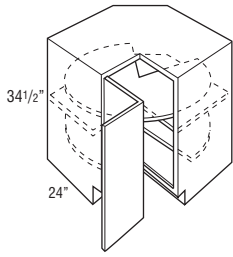

Due to fixed shelf mounting, shelves cannot be retrofitted.

	1	2	3	4	5	6	7	8
BC33SS L or R	1742	1871	1890	2062	2075	2102	2205	2384
BC36SS L or R	1782	1917	1928	2070	2093	2117	2248	2432

- BC33SS L or R wall width is 33" x 33".
- BC36SS L or R wall width is 36" x 36".
- BC33SS - Susans are 28" diameter.
- BC36SS - Susans are 32" diameter.
- Features two plywood revolving shelves. Lower shelf is mounted to floor. Upper shelf is mounted to fixed shelf. Fixed shelf is 1/2" thick laminated furniture board.
- Decorative hardware screws must be countersunk to prevent scratching adjacent cabinets and face frame of BC.
- Not recommended for use next to an appliance deeper than standard cabinet depth.

Modifications

AUTH	CBO	CCO	CFNTO	CFP	CFRMO	CND	EX	FB	FD	FDRW	FPEB	FTK	FTK_V	MI	NSCH	P	RD	RECTKALL	RECTKBK	RECTKL/R	RT	VTK	
	•							•			•				STD								•

Construction Upgrades

APU	PEU
•	•

Asymmetrical Super Susan

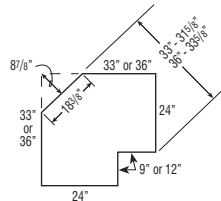
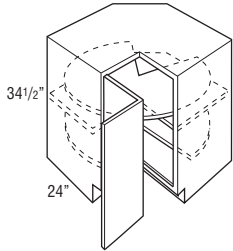

Due to fixed shelf mounting, shelves cannot be retrofitted.

	1782	1917	1928	2070	2093	2117	2248	2432
BC3336SS L or R								
BC3633SS L or R	1782	1917	1928	2070	2093	2117	2248	2432

- BC3336SS L or R wall width is 33" x 36".
- BC3633SS L or R wall width is 36" x 33".
- All Asymmetrical Super Susan shelves are 28" diameter.
- Features two plywood revolving shelves. Lower shelf is mounted to floor. Upper shelf is mounted to fixed shelf. Fixed shelf is 1/2" thick laminated furniture board.
- Nomenclature for asymmetrical cabinets reads as follows:
First set of numbers = left side of cabinet dimensions.
Second set of numbers = right side of cabinet dimensions.
- Decorative hardware screws must be countersunk to prevent scratching adjacent cabinets and face frame of BC.
- Not recommended for use next to an appliance deeper than standard cabinet depth.

Modifications

AUTH	CBO	CCO	CFNTO	CFP	CFRMO	CND	EX	FB	FD	FDRW	FPEB	FTK	FTK_V	MI	NSCH	P	RD	RECTKALL	RECTKBK	RECTKL/R	RT	VTK	
	•							•			•				STD								•

Construction Upgrades

APU	PEU
•	•

1	2	3	4	5	6	7	8
---	---	---	---	---	---	---	---

Angle Base

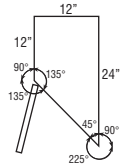
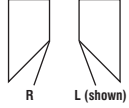
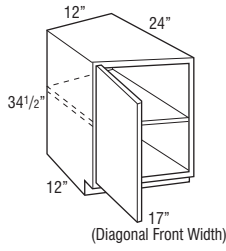

AB12 L or R

380	464	504	515	558	571	602	678
-----	-----	-----	-----	-----	-----	-----	-----

- One adjustable shelf.
- Cabinets constructed with top.
- Door hinged on shallow depth side.
- To allow for proper door clearance of adjacent cabinets, all door styles regardless of overlay utilize 14 1/2" wide doors with a traditional overlay hinge.

Modifications

AUTH	CBO	CCO	CFNTO	CFP	CFRMO	CND	EX	FB	FD	FDRW	FPEB	FTK	FTK_V	MI	NSCH	P	RD	RECTKALL	RECTKBK	RECTKL/R	RT	VTK
•*	•	•	•	•	•	•	•	•	•	•	•*	•	•	•	•	•	•▲	•	•	•▲	•	•

*AUTH and FPEB available only on 12" deep side of cabinet. *RD to 18" available.
▲RECTKL and RECTKR cannot be ordered when RD is specified. RECTKL and RECTKR cannot be specified on the same cabinet.

Construction Upgrades

APU	PEU
•	•

Angle End Base

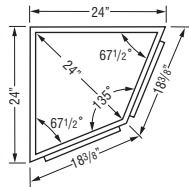
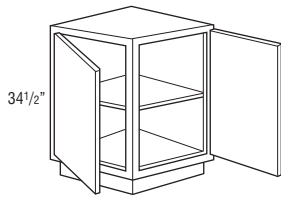

Top View

AEB24

689	783	846	868	931	965	1013	1146
-----	-----	-----	-----	-----	-----	------	------

- Wall width is 24" x 24".
- 24" W x 24" D x 34 1/2" H.
- 24" from outside corner point to frame face.
- Cabinets constructed with top.
- One adjustable shelf.
- Cabinet may be installed against either end of a run.

Modifications

AUTH	CBO	CCO	CFNTO	CFP	CFRMO	CND	EX	FB	FD	FDRW	FPEB	FTK	FTK_V	MI	NSCH	P	RD	RECTKALL	RECTKBK	RECTKL/R	RT	VTK
•	•	•	•	•	•	•	•	•	•	•	•	•	•	•	•	•	•	•	•	•	•	•

Construction Upgrades

APU	PEU
•	•

Two Drawer Base

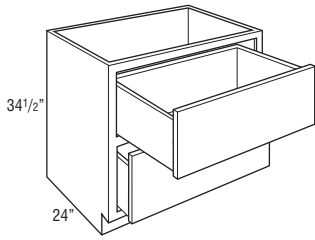

	1	2	3	4	5	6	7	8
2BD18	618	639	650	665	672	683	699	736
2BD21	658	676	689	704	710	726	739	780
2BD24	710	733	747	761	768	785	799	845
2BD27	891	917	936	955	965	984	1002	1058
2BD30†	1239	1273	1298	1321	1335	1358	1383	1456
2BD33†	1320	1357	1382	1409	1421	1448	1475	1551
2BD36†	1359	1398	1425	1450	1463	1491	1519	1598

†Standard drawers are solid-wood dovetail drawers with undermount full extension guides.

Modifications

AUTH	CBO	CCO	CFNTO	CFP	CFRMO	CND	EX	FB	FD	FDRW	FPEB	FTK	FTK_V	MI	NSCH	P	RD	RECTKALL	RECTKBK	RECTKL/R	RT	VTK	
•	•	•	•	•	•	•	•	•	•	•	•	•	•	•	•	•	•	•*	•	•	•	•	•

*RECTKALL available for 2BD27-2BD36.

Construction Upgrades

APU	PEU
•	•

Two Drawer Base with Roll Tray

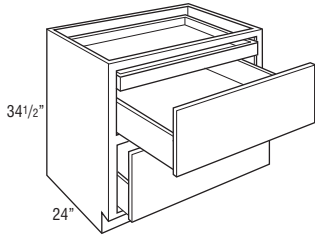

	1	2	3	4	5	6	7	8
2BD24RT	810	833	847	861	868	885	899	945
2BD30RT	1344	1378	1403	1426	1440	1463	1488	1561
2BD36RT	1469	1508	1535	1560	1573	1601	1629	1708

- Includes a roll tray inside top drawer.
- Exterior height for bottom drawer box is 6 3/8".

Modifications

AUTH	CBO	CCO	CFNTO	CFP	CFRMO	CND	EX	FB	FD	FDRW	FPEB	FTK	FTK_V	MI	NSCH	P	RD	RECTKALL	RECTKBK	RECTKL/R	RT	VTK	
•	•	•	•	•	•	•	•	•	•	•	•	•	•	•	•	•	•	•*	•	•	•	STD	•

*RECTKALL not available on 2BD24RT.

Construction Upgrades

APU	PEU
•	•

Two Drawer Base Drop-in Range

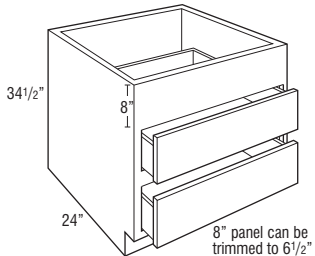

	1	2	3	4	5	6	7	8
2BD36DR	1359	1398	1425	1450	1463	1491	1519	1598

- Standard drawers are solid-wood dovetail drawers with undermount full extension guides.

Modifications

AUTH	CBO	CCO	CFNTO	CFP	CFRMO	CND	EX	FB	FD	FDRW	FPEB	FTK	FTK_V	MI	NSCH	P	RD	RECTKALL	RECTKBK	RECTKL/R	RT	VTK	
•	•	•	•	•	•	•	•	•	•	•	•	•	•	•	•	•	•	•	•	•	•	•	•

Construction Upgrades

APU	PEU
•	•

Three Drawer Base

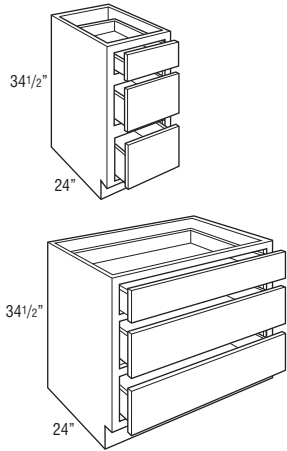

	1	2	3	4	5	6	7	8
3BD12	556	572	584	596	602	614	626	661
3BD15	584	602	614	626	632	645	659	695
3BD18	618	639	650	665	672	683	699	736
3BD21	658	676	689	704	710	726	739	780
3BD24	710	733	747	761	768	785	799	845
3BD27	891	917	936	955	965	984	1002	1058
BD30D†*	1268	1302	1326	1350	1362	1387	1412	1484
BD33D†*	1320	1357	1382	1409	1421	1448	1475	1551
BD36D†*	1359	1398	1425	1450	1463	1491	1519	1598

†Deep drawers are solid-wood dovetail drawers with undermount full extension guides. Top drawer is standard construction with 3/4 extension guides. When WDRW is selected, all three drawers and guides are upgraded.

*Exterior height of bottom two drawers is 6 3/8".

Modifications

AUTH	CBO	CCO	CFNTO	CFP	CFRMO	CND	EX	FB	FD	FDRW	FPEB	FTK	FTK_V	MI	NSCH	P	RD	RECTKALL	RECTKKBK	RECTKL/R	RT	VTK	
•	•	•	•	•	•	•	•	•	•	•*	•	•	•*	•	•	•	•	•	•	•	•	•	•

*FDRW not available on BD30D-BD36D. *FTKAV/FTKFV not available on 3BD12. *RECTKALL available for 3BD27 and BD30D-BD36D.

Construction Upgrades

APU	PEU
•	•

Three Drawer Base with Wood Tiered Cutlery Divider Drawer

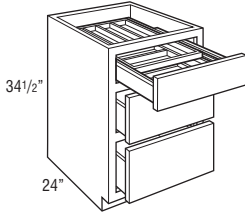

3BD15WTCD	1047	1065	1077	1089	1095	1108	1122	1158
3BD18WTCD	1096	1117	1128	1143	1150	1161	1177	1214
3BD21WTCD	1156	1174	1187	1202	1208	1224	1237	1278
3BD24WTCD	1225	1248	1262	1276	1283	1300	1314	1360

- Includes Wood Tiered Cutlery Divider Drawer in top drawer.
- Exterior height for lower drawer boxes is 6 3/8".
- Exterior WTCD drawer box height is 3 3/4", interior height of top tier is 1 5/8", and interior height of bottom tier is 1 3/8".

Modifications

AUTH	CBO	CCO	CFNTO	CFP	CFRMO	CND	EX	FB	FD	FDRW	FPEB	FTK	FTK_V	MI	NSCH	P	RD	RECTKALL	RECTKKBK	RECTKL/R	RT	VTK	
•	•	•	•	•	•	•	•	•	•	•	•	•	•	•	•	•	•	•	•	•	•	•	•

Construction Upgrades

APU	PEU
•	•

Four Drawer Base

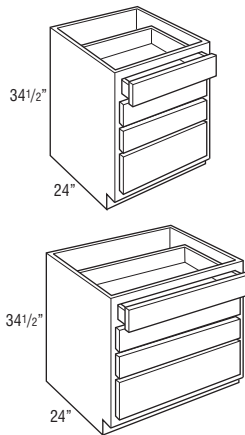

4BD12	580	599	611	622	629	642	653	690
4BD15	617	636	648	662	670	681	697	734
4BD18	650	671	682	698	704	718	733	772
4BD21	695	713	730	742	750	766	783	824
4BD24	753	774	790	805	815	829	848	894
4BD27	980	1009	1029	1051	1060	1083	1103	1163
4BD30	1077	1109	1132	1156	1166	1191	1214	1279

Modifications

AUTH	CBO	CCO	CFNTO	CFP	CFRMO	CND	EX	FB	FD	FDRW	FPEB	FTK	FTK_V	MI	NSCH	P	RD	RECTKALL	RECTKKBK	RECTKL/R	RT	VTK	
•	•	•	•	•	•	•	•	•	•	•	•	•	•*	•	•	•	•	•	•	•	•	•	•

*FTKAV/FTKFV not available on 4BD12. *RECTKALL available for 4BD27-4BD30.

Construction Upgrades

APU	PEU
•	•

Four Drawer Base with Wood Tiered Cutlery Divider Drawer

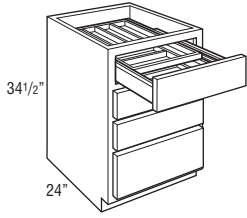

	1	2	3	4	5	6	7	8
4BD15WTC	1080	1099	1111	1125	1133	1144	1160	1197
4BD18WTC	1128	1149	1160	1176	1182	1196	1211	1250
4BD21WTC	1193	1211	1228	1240	1248	1264	1281	1322
4BD24WTC	1268	1289	1305	1320	1330	1344	1363	1409

- Includes Wood Tiered Cutlery Divider Drawer in top drawer.
- Exterior WTC drawer box height is 3 3/4", interior height of top tier is 1 5/8", and interior height of bottom tier is 1 3/8".

Modifications

AUTH	CBO	CCO	CFNTD	CFP	CFRMO	CND	EX	FB	FD	FDRW	FPEB	FTK	FTK_V	MI	NSCH	P	RD	RECTKALL	RECTKBK	RECTKL/R	RT	VTK	
•	•	•	•	•	•	•	•	•	•	•	•	•	•	•	•	•	•	•	•	•	•	•	•

Construction Upgrades

APU	PEU
•	•

Base Wastebasket

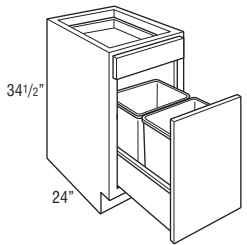
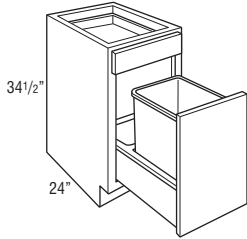

BWB15	843	987	1056	1074	1145	1195	1269	1358
--------------	-----	-----	------	------	------	------	------	------

BWB18	971	1146	1215	1255	1320	1397	1483	1588
--------------	-----	------	------	------	------	------	------	------

BWB21	1069	1261	1337	1382	1452	1537	1631	1747
--------------	------	------	------	------	------	------	------	------

- BWB15 includes one 35 qt. basket.
- BWB18 and BWB21 include two 35 qt. baskets.
- Construction has wastebasket pull-out using SoftTouch guides.
- Bottom drawer is dovetailed.

Modifications

AUTH	CBO	CCO	CFNTD	CFP	CFRMO	CND	EX	FB	FD	FDRW	FPEB	FTK	FTK_V	MI	NSCH	P	RD	RECTKALL	RECTKBK	RECTKL/R	RT	VTK	
•	•	•	•	•	•	•	•	•	•	•	•	•	•	•	•	•	•	•	•	•	•	•	•

Construction Upgrades

APU	PEU
•	•

Base Wastebasket, Full Height

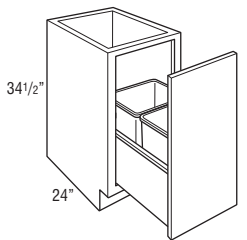
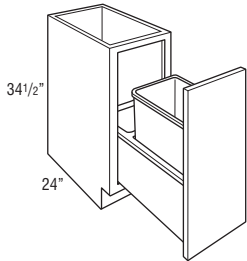

BWB15FH	759	888	950	967	1031	1076	1142	1222
----------------	-----	-----	-----	-----	------	------	------	------

BWB18FH2	874	1031	1094	1130	1188	1257	1335	1429
-----------------	-----	------	------	------	------	------	------	------

BWB21FH	962	1135	1203	1244	1307	1383	1468	1572
----------------	-----	------	------	------	------	------	------	------

- BWB15FH includes one 50 qt. basket.
- BWB18FH2 includes two 35 qt. baskets.
- BWB21FH includes two 50 qt. baskets.
- Construction has wastebasket pull-out using SoftTouch guides.
- Bottom drawer is dovetailed.

Modifications

AUTH	CBO	CCO	CFNTD	CFP	CFRMO	CND	EX	FB	FD	FDRW	FPEB	FTK	FTK_V	MI	NSCH	P	RD	RECTKALL	RECTKBK	RECTKL/R	RT	VTK	
•	•	•	•	•	•	•	•	•	•	•	•	•	•	•	•	•	•	•	•	•	•	•	•

Construction Upgrades

APU	PEU
•	•

Base Wine Cubby

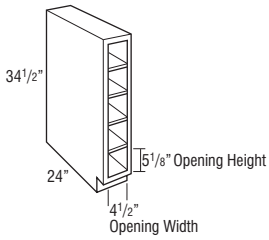

BWC6	793	793	793	793	793	793	793	793
-------------	-----	-----	-----	-----	-----	-----	-----	-----

- Vertical application only.
- Matching interior.
- Frameless construction.
- Veneer on 3/4" furniture board core.
- Reduced Depth only available in 3" increments down to 12".

Modifications

AUTH	CBO	CCO	CFNTO	CFP	CFRMO	CND	EX	FB	FD	FDRW	FPEB	FTK	FTK_V	MI	NSCH	P	RD	RECTKALL	RECTKBK	RECTKL/R	RT	VTK	
														STD									

Construction Upgrades

APU	PEU

Base Pantry Pull-out

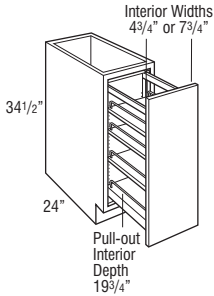

B9PO	793	858	870	932	945	967	1010	1092
-------------	-----	-----	-----	-----	-----	-----	------	------

B12PO	926	1010	1051	1061	1103	1117	1148	1197
--------------	-----	------	------	------	------	------	------	------

- Full extension, SoftTouch wood pull-out with 1 fixed shelf and 3 adjustable shelves with chrome finished side rails.

Modifications

AUTH	CBO	CCO	CFNTO	CFP	CFRMO	CND	EX	FB	FD	FDRW	FPEB	FTK	FTK_V	MI	NSCH	P	RD	RECTKALL	RECTKBK	RECTKL/R	RT	VTK
•	•	•			•		•	•			•	•							•	•		•

Construction Upgrades

APU	PEU
•	•

Base Utensil Pantry Pull-out

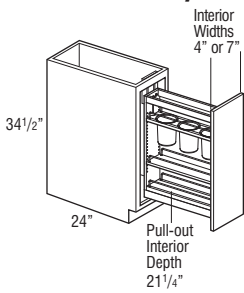

BUPP9	1192	1256	1268	1330	1343	1365	1409	1490
--------------	------	------	------	------	------	------	------	------

BUPP12	1324	1409	1449	1459	1501	1516	1547	1595
---------------	------	------	------	------	------	------	------	------

- All styles include a natural finish SoftTouch wood pull-out with two adjustable shelves (including canister shelf) and one fixed shelf with chrome rail sides.
- Top shelf features three stainless steel canisters for utensils.
- The adjustable rear wall of the pull-out prevents items from falling behind the unit.
- BUPP9 canisters are 5.85" tall and have an inside diameter of 4.3".
- BUPP12 canisters are 6.7" tall and have an inside diameter of 5".

Modifications

AUTH	CBO	CCO	CFNTO	CFP	CFRMO	CND	EX	FB	FD	FDRW	FPEB	FTK	FTK_V	MI	NSCH	P	RD	RECTKALL	RECTKBK	RECTKL/R	RT	VTK
•	•	•			•		•	•			•	•							•	•		•

Construction Upgrades

APU	PEU
•	•

Base Utensil Pantry Pull-out with Knife Block

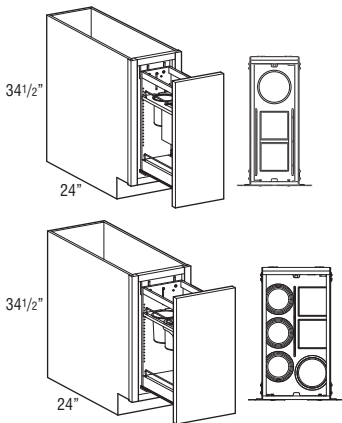

BUPPKB12	1862	1947	1987	1997	2039	2054	2085	2133
-----------------	------	------	------	------	------	------	------	------

BUPPKB15	2276	2361	2401	2411	2453	2468	2498	2547
-----------------	------	------	------	------	------	------	------	------

- Full extension, SoftTouch wood pull-out with natural finish and one fixed shelf.
- BUPPKB12 features an adjustable shelf with two knife blocks, one stainless steel canister, four cutting boards, and one fixed shelf with chrome rails. Canister is 6.7" tall and has an inside diameter of 5".
- BUPPKB15 features an adjustable shelf with two knife blocks, four stainless steel canisters, four cutting boards, and one fixed shelf with chrome rails. Three canisters are 5.85" tall and have an inside diameter of 4.3", and one is 6.7" tall with an inside diameter of 5".
- Knife blocks feature movable flex rods that adjust to hold a multitude of knives.
- Includes adjustable rear wall for extra strength and stability.

Modifications

AUTH	CBO	CCO	CFNTO	CFP	CFRMO	CND	EX	FB	FD	FDRW	FPEB	FTK	FTK_V	MI	NSCH	P	RD	RECTKALL	RECTKBK	RECTKL/R	RT	VTK
•	•	•			•		•	•			•	•	•*						•	•		•

*FTKAV/FTKFV not available on BUPPKB12.

Construction Upgrades

APU	PEU
•	•

Base Corner Peninsula

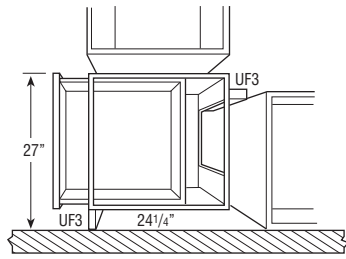

BCP24B

767

895

939

999

1112

1160

1219

1317

- Cabinet width is 24".
- Adjustable full depth shelf.
- Includes two 3" fillers, shipped unattached. Fillers are required for drawer and door opening clearance of adjacent cabinets.
- Unfinished toe-kick on front (B24) and back (BCP) of cabinet.
- Will not accept roll trays.
- Peninsula base cabinets are 1/4" deeper to allow back paneling application on adjacent cabinets in a run with standard 24" deep cabinets.

Modifications

AUTH	CBO	CCO	CFNTO	CFP	CFRMO	CND	EX	FB	FD	FDRW	FPEB	FTK	FTK_V	MI	NSCH	P	RD	RECTKALL	RECTKBK	RECTKL/R	RT	VTK	
•	•	•		•		•		•	•	•	•	•	•			•	•	•	•	•	•	•	•

Construction Upgrades

APU	PEU
•	•

Base Corner Peninsula with Full Height Door

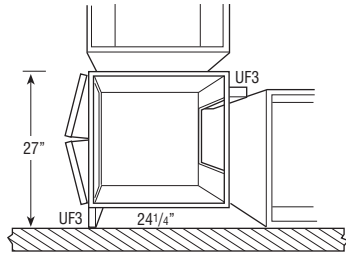

BCP24BFH

767

895

999

1009

1112

1160

1219

1317

- Cabinet width is 24".
- Adjustable full depth shelf.
- Includes two 3" fillers, shipped unattached. Fillers are required for drawer and door opening clearance of adjacent cabinets.
- Unfinished toe-kick on front (B24) and back (BCP) of cabinet.
- Will not accept roll trays.
- Peninsula base cabinets are 1/4" deeper to allow back paneling application on adjacent cabinets in a run with standard 24" deep cabinets.

Modifications

AUTH	CBO	CCO	CFNTO	CFP	CFRMO	CND	EX	FB	FD	FDRW	FPEB	FTK	FTK_V	MI	NSCH	P	RD	RECTKALL	RECTKBK	RECTKL/R	RT	VTK	
•	•	•						•			•	•	•			•	•	•	•	•	•	•	•

Construction Upgrades

APU	PEU
•	•

30" SuperCabinet™

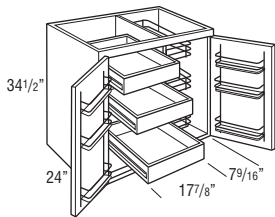

BSC30RTL

1602

1684

1729

1771

1786

1826

1897

1970

BSC30RTR

1602

1684

1729

1771

1786

1826

1897

1970

- Roll Trays and Wire Pull-outs feature SoftTouch.
- Integrated SoftTouch hinge not included. Premium door mechanism installed.
- Cabinets utilize 170° hinge. For sufficient pull-out clearance, 12" of adjacent space is required for door to open 170° when installed near a wall or corner.
- Both doors have chrome and wood three-tiered 3" deep racks.

Modifications

AUTH	CBO	CCO	CFNTO	CFP	CFRMO	CND	EX	FB	FD	FDRW	FPEB	FTK	FTK_V	MI	NSCH	P	RD	RECTKALL	RECTKBK	RECTKL/R	RT	VTK	
•	•	•			•			•			•	•	•	•	•	•	•	•	•	•	•	•	•

Construction Upgrades

APU	PEU
•	•

BSC30RTL

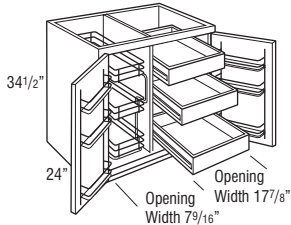

BSC30RTR

36" SuperCabinet™

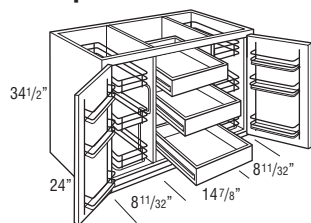

BSC36PRP

2237

2319

2363

2406

2418

2460

2532

2619

- Roll Trays and Wire Pull-outs feature SoftTouch.
- Integrated SoftTouch hinge not included. Premium door mechanism installed.
- Cabinets utilize 170° hinge. For sufficient pull-out clearance, 12" of adjacent space is required for door to open 170° when installed near a wall or corner.
- Both doors have chrome and wood three-tiered 3" deep racks.

Modifications

AUTH	CBO	CCO	CFNTO	CFP	CFRMO	CND	EX	FB	FD	FDRW	FPEB	FTK	FTK_V	MI	NSCH	P	RD	RECTKALL	RECTKBK	RECTKL/R	RT	VTK	
•	•	•			•			•			•	•	•	•	•	•	•	•	•	•	•	•	•

Construction Upgrades

APU	PEU
•	•

Base Cabinet with Mixer Lift

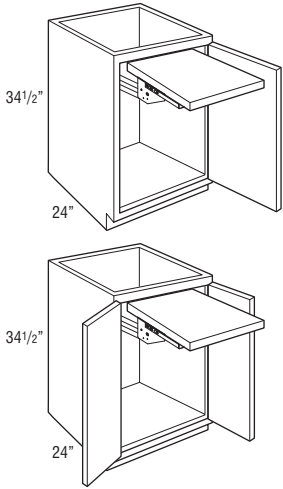

Price Point	1	2	3	4	5	6	7	8
B18FHMIX L or R	2084	2184	2223	2247	2287	2318	2362	2473
B21FHMIX L or R	2375	2475	2510	2546	2576	2619	2664	2768
B24FHMIX L or R	2676	2790	2834	2867	2910	2957	3000	3112
B24BFHMIX	2704	2827	2870	2910	2949	3005	3043	3172

- SoftTouch mixer lift.
- Mixer shelf will be 3/4" thick, mixer shelf dimensions:
18" wide: 11 3/4" wide x 20" deep.
21" wide: 14 3/4" wide x 20" deep.
24" wide: 17 3/4" wide x 20" deep.
- Maximum Weight Capacity for Mixer Shelf: 60 lbs.
- Mixer shelf locks in the fully open position. Release brackets lower the mixer shelf back into the cabinet.
- When installed in 34 1/2" full height cabinet and in closed position, clearance above shelf is 17 5/8"; clearance below shelf is 7 3/4".
- Mixer shelf is not intended to support mixer while mixer is in use.

Modifications

AUTH	CBO	CCO	CFNTO	CFP	CFRMO	CND	EX	FB	FD	FDRW	FPEB	FTK	FTK_V	MI	NSCH	P	RD	RECTKALL	RECTKBK	RECTKL/R	RT	VTK	
•	•	•	•	•	•	•	•	•	•	•	•	•	•	•	•	•	•	•	•	•	•	•	•

Construction Upgrades

APU	PEU
•	•
STD	

Base Pull-out Filler, Plain

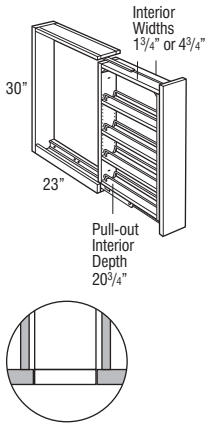

Top View

BPOF3PL	422	422	422	422	422	422	422	422
BPOF6PL	520	520	520	520	520	520	520	520

- Actual space required is 3 1/8" and 6 1/8" wide. May require trimming for top moulding applications or countertops that lip over the base top rail.
- Recommended installation between 2 cabinets.
- Can also be installed between a cabinet and a wall or between a cabinet and an end panel; requires 1/4" space filler for clearance.
- For full access from both sides of unit, do not install against a wall or next to deeper appliances and cabinets.
- Filler is included but unattached.
- Install unit before removing shipping brace and attaching filler.
- Decorative hardware required on base units.
- Toekick not included; must be built up in the field.
- All styles feature a natural finish wood pull-out with adjustable shelves and chrome rail sides.
- Pull-out is full extension.

MODIFICATIONS

No modifications available for these products.

Base Pull-out Filler, Overlay

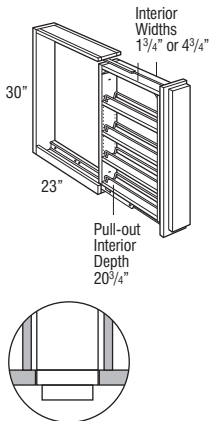

Top View

BPOF3OV	446	446	446	446	446	446	446	446
BPOF6OV	572	572	572	572	572	572	572	572

- Actual space required is 3 1/8" and 6 1/8" wide. May require trimming for top moulding applications or countertops that lip over the base top rail.
- Recommended installation between 2 cabinets.
- Can also be installed between a cabinet and a wall or between a cabinet and an end panel; requires 1/4" space filler for clearance.
- For full access from both sides of unit, do not install against a wall or next to deeper appliances and cabinets.
- Filler is included but unattached.
- Install unit before removing shipping brace and attaching filler.
- Overlay application includes profiled full overlay filler.
- Waldron PureStyle™ overlays will be painted hardwood.
- Decorative hardware required on base units.
- Toekick not included; must be built up in the field.
- All styles feature a natural finish wood pull-out with adjustable shelves and chrome rail sides.
- Pull-out is full extension.

MODIFICATIONS

No modifications available for these products.

All UA Cabinets are 32 1/2" high unless otherwise noted.



MODIFICATIONS			
Mod.	Description	Mod.	Description
CBO	Cabinet Box Only	FB	Finished Ends
CCO	Cabinet Case Only	FD	Full Depth Shelf
CFNTO	Cabinet Front Only	FDRW	Furniture Board Drawer
CFP	Cabinet False Panel	FPEB	Furniture Finished Plywood End Panels
CFRMO	Cabinet Frame Only	MI	Matching Interior
CND	Cabinet with No Door, with Drawer	NSCH	Non SoftTouch Hinge
EXL	Extended Stile Left	RD	Reduced Depth
EXR	Extended Stile Right	RT	Roll Tray
		VTK	Void Toekick

CONSTRUCTION UPGRADES	
Mod.	Description
APU	All-plywood Unfinished
PEU	Plywood Ends Unfinished

MODIFICATIONS GRID KEY	
•	Available
STD	Standard on these cabinets

	Price Point	Cabinet Width							
		1	2	3	4	5	6	7	8
	B1232.5 L or R	380	464	504	515	558	571	602	650
	B1532.5 L or R	401	488	527	541	577	600	633	683
	B1832.5 L or R	432	522	559	579	615	644	682	738
	B2132.5 L or R	470	562	595	625	651	691	734	793

• Adjustable 15" deep shelf.

Modifications

CBO	CCO	CFNTO	CFP	CFRMO	CND	EX	FB	FD	FDRW	FPEB	MI	NSCH	RD	RT	VTK
•	•	•	•	•	•	•	•	•	•	•	•	•	•	•	•

Construction Upgrades

APU	PEU
•	•

	B2432.5B	544	653	698	731	767	818	853	923
	B3032.5B	670	796	839	887	1001	1041	1094	1183
	B3632.5B	741	880	924	978	1094	1148	1209	1307

• Adjustable 15" deep shelf.

Modifications

CBO	CCO	CFNTO	CFP	CFRMO	CND	EX	FB	FD	FDRW	FPEB	MI	NSCH	RD	RT	VTK
•	•	•	•	•	•	•	•	•	•	•	•	•	•	•	•

Construction Upgrades

APU	PEU
•	•

	3BD1532.5	642	662	675	689	695	710	725	765
	3BD1832.5	680	703	715	732	739	751	769	810
	3BD2432.5	781	806	822	837	845	864	879	930

Modifications

CBO	CCO	CFNTO	CFP	CFRMO	CND	EX	FB	FD	FDRW	FPEB	MI	NSCH	RD	RT	VTK
•	•	•	•	•	•	•	•	•	•	•	•	•	•	•	•

Construction Upgrades

APU	PEU
•	•

	SB3032.5B	527	631	679	704	755	796	842	908
	SB3632.5B	571	689	764	768	842	901	951	1027

Modifications

CBO	CCO	CFNTO	CFP	CFRMO	CND	EX	FB	FD	FDRW	FPEB	MI	NSCH	RD	RT	VTK
•	•	•	STD	•	•	•	•	•	•	•	•	•	•	•	•

Construction Upgrades

APU	PEU
•	•

Universal Access Base Corner Super Susan with Wood Shelves

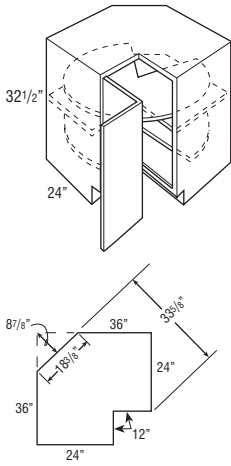

Due to fixed shelf mounting, shelves cannot be retrofitted.

Price Point	1	2	3	4	5	6	7	8
BC3632.5SS L or R	1782	1917	1928	2070	2093	2117	2248	2432

- Includes two 32" diameter wood shelves that spin independently.
- Decorative hardware screws must be countersunk to prevent scratching of adjacent cabinets and face frame.

Modifications

CBO	CCO	CFNTO	CFP	CFRMO	CND	EX	FB	FD	FDRW	FPEB	MI	NSCH	RD	RT	VTK
•							•			•		STD			•

Construction Upgrades

APU	PEU
•	•

Universal Access Base Microwave with Deep Drawer

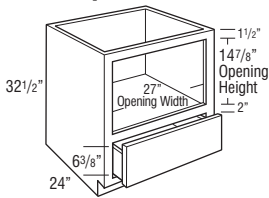

BMW3032.5	884	911	930	947	957	975	996	1052
------------------	-----	-----	-----	-----	-----	-----	-----	------

- 1 deep drawer below microwave.
- Matching Interior.

Modifications

CBO	CCO	CFNTO	CFP	CFRMO	CND	EX	FB	FD	FDRW	FPEB	MI	NSCH	RD	RT	VTK
•				•			•	STD			•	STD			•

Construction Upgrades

APU	PEU

Vanity Wall Sink

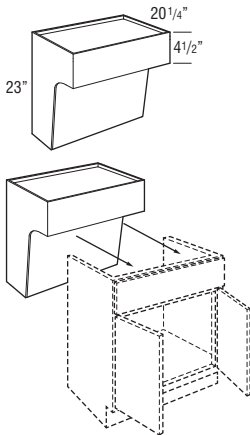

VWS2723	791	791	791	791	791	791	791	791
VWS3023	842	842	842	842	842	842	842	842
VWS3323	895	895	895	895	895	895	895	895

- Matching Interior.
- Recommended installation height of 32" high with 9" of clearance below.
- Front panel is attached with clips for easy removal for access to plumbing.
- Finished veneer plywood exterior and interior.
- For proper installation, cabinet must be secured on each side through both the top and bottom of the back panel into wall studs. Installation instructions and required 3 1/2" installation screws included, standard 2 1/2" installation screws are not sufficient in this application.
- Features a full cabinet top that can be routed for sink installation.
- Approximate weight limit is 400 lbs. per cabinet (includes weight of the cabinet, countertop and contents). Proper installation is required and additional bracing may be required.
- Includes connector clips to mount the sink base to the Removable Vanity Sink Base (RVWS..32). RVWS..32 not included, see below.

Modifications

CBO	CCO	CFNTO	CFP	CFRMO	CND	EX	FB	FD	FDRW	FPEB	MI	NSCH	RD	RT	VTK
										STD	STD				

Construction Upgrades

APU	PEU

Removable Vanity Sink Base

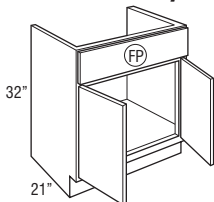

RVWS3032B	635	739	809	822	887	923	966	1046
RVWS3332B	679	797	876	887	967	1004	1056	1142
RVWS3632B	694	807	893	897	984	1040	1093	1182

- Must be ordered with Vanity Wall Sink (VWS..23), not designed to be a stand-alone unit.
 - RVWS3032B is compatible with VWS2723
 - RVWS3332B is compatible with VWS3023
 - RVWS3632B is compatible with VWS3323
- Cabinet is able to be removed for handicap accessible use.
- Includes connector clips to mount the sink base to the Vanity Wall Sink (VWS..23).
- RVWS units are 32" high to match standard vanity cabinets.

Modifications

CBO	CCO	CFNTO	CFP	CFRMO	CND	EX	FB	FD	FDRW	FPEB	MI	NSCH	RD	RT	VTK
•	•			•						STD	•	•			

Construction Upgrades

APU	PEU
STD	

TALL CABINET NOMENCLATURE

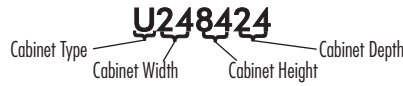

MODIFICATIONS GRID KEY

- Available
- STD Standard on these cabinets

MODIFICATIONS

Mod.	Description	Mod.	Description	Mod.	Description	Mod.	Description
ACS	Appliance Cut-out, Single	CFRMO	Cabinet Frame Only	FPEB	Furniture Finished Plywood End Panels	MI	Matching Interior
AUTHB	Authentic Ends Both	CND	Cabinet with No Door, with Drawer	FTK	Flush Toekick	NSCH	Non SoftTouch Hinge
AUTHL	Authentic End Left	EXL	Extended Stile Left	FTKAV	Flush Toekick Arch	RD	Reduced Depth
AUTHR	Authentic End Right	EXR	Extended Stile Right	FTKAV	Flush Toekick Arch	RECTKL	Recessed Toekick Left
CBO	Cabinet Box Only	FB	Finished Ends	FTKRV	Flush Toekick Furniture	RECTKR	Recessed Toekick Right
CCO	Cabinet Case Only	FDRW	Furniture Board Drawer	FULL	Full Overlay	RT	Roll Tray
CFNTO	Cabinet Front Only			MFO	Modified Full Overlay	VTK	Void Toekick

CONSTRUCTION UPGRADES

Mod.	Description
APU	All-plywood Unfinished
PEU	Plywood Ends Unfinished

DECORATIVE DOOR OPTIONS

Mod.	Description
CG	Cut-for-glass Doors

Utility, 84", 87", or 90" Tall, 12" Deep

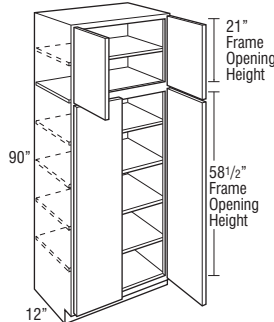
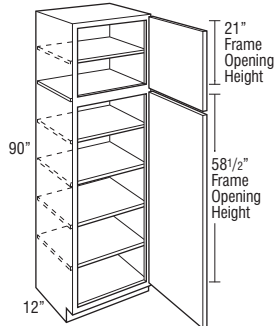
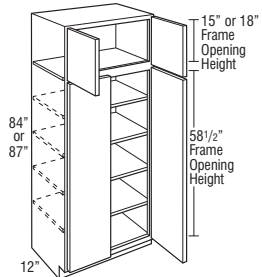
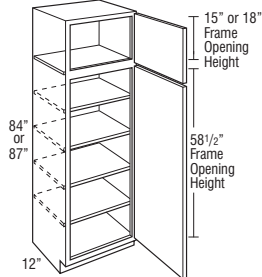

	Price Point	1	2	3	4	5	6	7	8
U128412 L or R		795	902	981	995	1073	1086	1186	1244
U158412 L or R		806	912	995	1006	1085	1100	1200	1257
U188412 L or R		902	1024	1094	1126	1197	1214	1323	1382
U218412 L or R		1002	1130	1197	1244	1306	1324	1440	1515
U248412 L or R		1124	1270	1319	1397	1436	1455	1584	1664
U128712 L or R		824	928	1006	1017	1101	1133	1229	1330
U158712 L or R		835	938	1020	1029	1115	1146	1245	1345
U188712 L or R		932	1049	1133	1156	1234	1265	1375	1480
U218712 L or R		1031	1166	1239	1283	1353	1381	1500	1616
U248712 L or R		1149	1305	1370	1433	1494	1522	1661	1784

U248412B	1174	1328	1380	1462	1505	1525	1658	1742
U278412	1300	1470	1515	1618	1653	1676	1836	1928
U308412	1414	1597	1639	1759	1789	1795	2001	2102
U338412	1495	1671	1709	1835	1863	1938	2101	2267
U368412	1572	1737	1775	1906	1932	2075	2195	2425
U248712B	1204	1366	1433	1503	1565	1595	1742	1872
U278712	1330	1519	1580	1668	1723	1769	1931	2073
U308712	1442	1660	1713	1823	1867	1931	2107	2263
U338712	1527	1740	1799	1913	1960	2066	2220	2418
U368712	1608	1818	1881	1999	2047	2196	2327	2565

U129012 L or R	824	928	1006	1017	1101	1133	1229	1330
U159012 L or R	835	938	1020	1029	1115	1146	1245	1345
U189012 L or R	932	1049	1133	1156	1234	1265	1375	1480
U219012 L or R	1031	1166	1239	1283	1353	1381	1500	1616
U249012 L or R	1149	1305	1370	1433	1494	1522	1661	1784

U249012B	1204	1366	1433	1503	1565	1595	1742	1872
U279012	1330	1519	1580	1668	1723	1769	1931	2073
U309012	1442	1660	1713	1823	1867	1931	2107	2263
U339012	1527	1740	1799	1913	1960	2066	2220	2418
U369012	1608	1818	1881	1999	2047	2196	2327	2565

- Four full depth adjustable shelves are included on 84" and 87" tall.
- Five full depth adjustable shelves are included on 90" tall.
- Tall mitered door styles and PureStyle™ door styles will feature one center panel, other door styles will feature two center panels.

Modifications

ACS	AUTH	CBO	CCO	CFNTO	CFRMO	CND	EX	FB	FDRW	FPEB	FTK	FTK_V	FULL/MFO	MI	NSCH	RD	RECTKL/R	RT	VTK
•	•	•	•	•	•	•	•	•	•	•	•	•*	•	•	•	•	•	•	•

*FTKAV/FTKRV not available on U128412, U128712, and U129012.

Construction Upgrades

APU	PEU
•	•

Decorative Door Options

CG

**Utility, 93" or 96" Tall,
12" Deep**

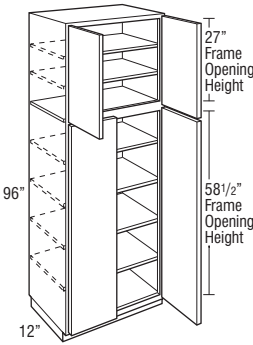
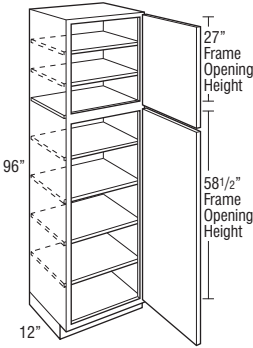
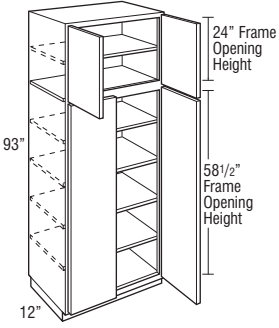
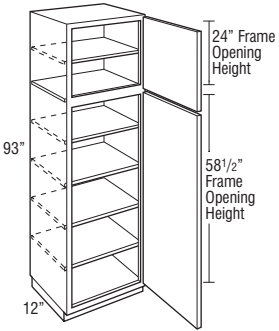

Price Point	1	2	3	4	5	6	7	8
U129312 L or R	847	943	1029	1041	1123	1200	1280	1409
U159312 L or R	857	956	1042	1054	1137	1215	1295	1426
U189312 L or R	959	1076	1156	1182	1265	1344	1432	1583
U219312 L or R	1057	1190	1277	1311	1393	1475	1567	1725
U249312 L or R	1173	1344	1420	1480	1548	1625	1732	1905

U249312B	1229	1410	1487	1551	1623	1701	1817	1996
U279312	1356	1569	1641	1727	1791	1889	2020	2214
U309312	1472	1717	1785	1892	1948	2064	2211	2421
U339312	1582	1803	1865	1984	2031	2174	2318	2544
U369312	1685	1884	1939	2069	2109	2277	2421	2599

U129612 L or R	847	943	1029	1041	1123	1200	1280	1409
U159612 L or R	857	956	1042	1054	1137	1215	1295	1426
U189612 L or R	959	1076	1156	1182	1265	1344	1432	1539
U219612 L or R	1057	1190	1277	1311	1393	1475	1567	1725
U249612 L or R	1173	1344	1420	1480	1548	1625	1732	1905

U249612B	1229	1410	1487	1551	1623	1701	1817	1996
U279612	1356	1569	1641	1727	1791	1889	2020	2214
U309612	1472	1717	1785	1892	1948	2064	2211	2421
U339612	1582	1803	1865	1984	2031	2174	2318	2544
U369612	1685	1884	1939	2069	2109	2277	2421	2660

- Five full depth adjustable shelves are included on 93" tall.
- Six full depth adjustable shelves are included on 96" tall.
- Toekick assembly shipped unattached, unless FTK options are selected.
- Tall mitered door styles and PureStyle™ door styles will feature one center panel, other door styles will feature two center panels.

Modifications

ACS	AUTH	CBO	CCO	CFNTO	CFRMO	CND	EX	FB	FDRW	FPEB	FTK	FTK_V	FULL/MFO	MI	NSCH	RD	RECTKL/R	RT	VTK
•	•	•	•	•	•	•	•	•	•	•	•	•*	•	•	•	•	•	•	•

*FTKAV/FTKFV not available on U129312 and U129612.

Construction Upgrades

APU	PEU
•	•

Decorative Door Options

CG
•

Utility, 84", 87", or 90" Tall, 24" Deep

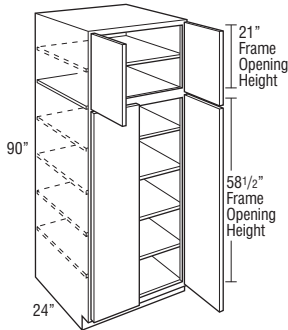
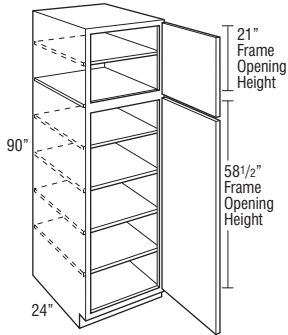
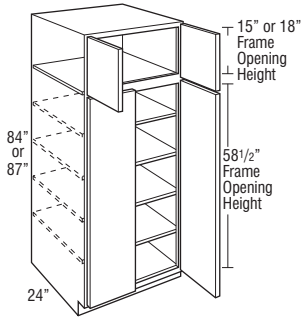
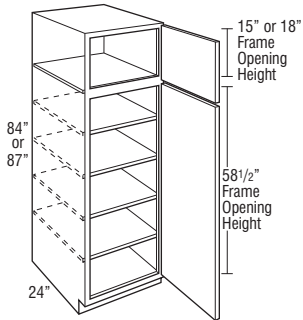

Price Point

	1	2	3	4	5	6	7	8
U128424 L or R	932	1045	1127	1160	1225	1241	1362	1423
U158424 L or R	949	1061	1143	1178	1244	1260	1383	1444
U188424 L or R	1053	1179	1251	1292	1360	1378	1512	1580
U218424 L or R	1168	1295	1373	1420	1489	1509	1652	1731
U248424 L or R	1320	1444	1524	1583	1658	1679	1833	1917
U128724 L or R	956	1079	1150	1183	1250	1317	1427	1535
U158724 L or R	973	1097	1167	1200	1269	1336	1447	1558
U188724 L or R	1078	1211	1284	1324	1398	1459	1583	1701
U218724 L or R	1200	1330	1414	1457	1538	1592	1727	1854
U248724 L or R	1355	1494	1575	1636	1716	1757	1906	2045

U248424B	1375	1508	1591	1654	1733	1754	1917	2005
U278424	1519	1652	1741	1812	1894	1897	2110	2213
U308424	1668	1801	1898	1974	2061	2078	2308	2421
U338424	1743	1908	1962	2091	2134	2223	2406	2592
U368424	1825	2021	2035	2214	2214	2372	2510	2771
U248724B	1414	1559	1646	1710	1794	1838	1995	2143
U278724	1560	1710	1811	1878	1973	2021	2198	2360
U308724	1712	1869	1982	2049	2155	2209	2409	2578
U338724	1789	1987	2064	2182	2245	2355	2529	2747
U368724	1873	2114	2153	2319	2341	2509	2660	2922

U129024 L or R	956	1079	1150	1183	1250	1317	1427	1535
U159024 L or R	973	1097	1167	1200	1269	1336	1447	1558
U189024 L or R	1078	1211	1284	1324	1398	1459	1583	1701
U219024 L or R	1200	1330	1414	1457	1538	1592	1727	1854
U249024 L or R	1355	1494	1575	1636	1716	1757	1906	2045

U249024B	1414	1559	1646	1710	1794	1838	1995	2143
U279024	1560	1710	1811	1878	1973	2021	2198	2360
U309024	1712	1869	1982	2049	2155	2209	2409	2578
U339024	1789	1987	2064	2182	2245	2355	2529	2747
U369024	1873	2114	2153	2319	2341	2509	2660	2922

- Four full depth adjustable shelves are included on 84" and 87" tall.
- Five full depth adjustable shelves are included on 90" tall.
- Tall mitered door styles and PureStyle™ door styles will feature one center panel, other door styles will feature two center panels.

Modifications

ACS	AUTH	CBO	CCO	CFNTO	CFRMO	CND	EX	FB	FDRW	FPEB	FTK	FTK_V	FULL/MFO	MI	NSCH	RD	RECTKL/R	RT	VTK
•	•	•	•	•	•	•	•	•	•	•	•	•*	•	•	•	•	•	•	•

*FTKAV/FTKEV not available on U128424, U128724, and U129024.

Construction Upgrades

APU	PEU
•	•

Decorative Door Options

CG

**Utility, 93" or 96" Tall,
24" Deep**

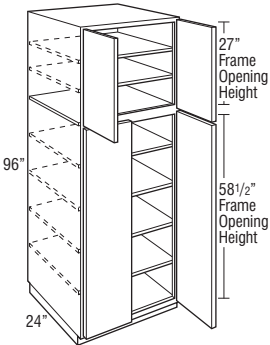
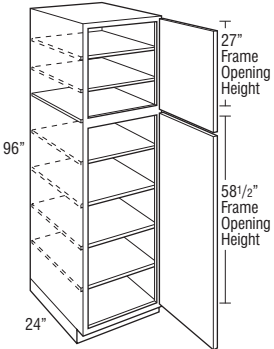
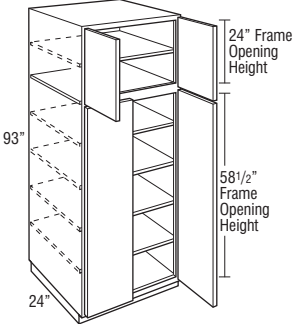
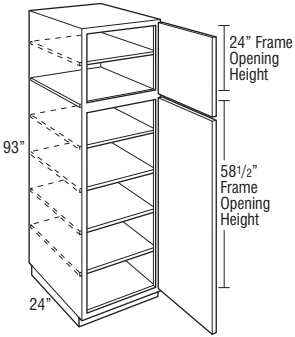

Price Point	1	2	3	4	5	6	7	8
U129324 L or R	985	1099	1180	1203	1279	1405	1492	1637
U159324 L or R	1000	1116	1198	1223	1299	1424	1513	1659
U189324 L or R	1113	1236	1318	1354	1435	1550	1647	1813
U219324 L or R	1231	1367	1451	1495	1578	1694	1802	1975
U249324 L or R	1391	1538	1630	1685	1773	1868	1984	2177
U249324B	1451	1606	1704	1761	1853	1955	2077	2279
U279324	1600	1770	1878	1941	2044	2150	2286	2508
U309324	1754	1939	2056	2126	2239	2351	2502	2739
U339324	1853	2060	2135	2259	2323	2470	2630	2882
U369324	1958	2186	2220	2398	2417	2600	2767	3034

U129624 L or R	985	1099	1180	1203	1279	1405	1492	1637
U159624 L or R	1000	1116	1198	1223	1299	1424	1513	1659
U189624 L or R	1113	1236	1318	1354	1435	1550	1647	1813
U219624 L or R	1231	1367	1451	1495	1578	1694	1802	1975
U249624 L or R	1391	1538	1630	1685	1773	1868	1984	2177

U249624B	1451	1606	1704	1761	1853	1955	2077	2279
U279624	1600	1770	1878	1941	2044	2150	2286	2508
U309624	1754	1939	2056	2126	2239	2351	2502	2739
U339624	1853	2060	2135	2259	2323	2470	2630	2882
U369624	1958	2186	2220	2398	2417	2600	2767	3034

- Five full depth adjustable shelves are included on 93" tall.
- Six full depth adjustable shelves are included on 96" tall.
- Toekick assembly shipped unattached, unless FTK options are selected.
- Tall mitered door styles and PureStyle™ door styles will feature one center panel, other door styles will feature two center panels.

Modifications

ACS	AUTH	CBO	CCO	CFNTO	CFRMO	CND	EX	FB	FDRW	FPEB	FTK	FTK_V	FULL/MFO	MI	NSCH	RD	RECTKL/R	RT	VTK
•	•	•	•	•	•	•	•	•	•	•	•	•*	•	•	•	•	•	•	•

*FTKAV/FTKFV not available on U129324 and U129624.

Construction Upgrades

APU	PEU
•	•

Decorative Door Options

CG

Utility with Roll Trays, 84", 87", or 90" Tall, 24" Deep

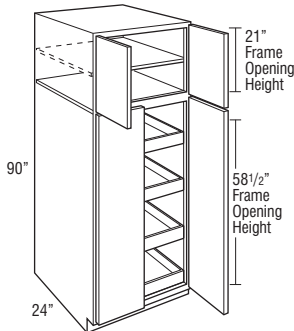
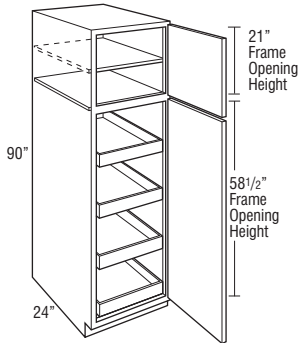
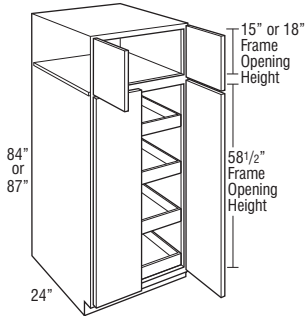
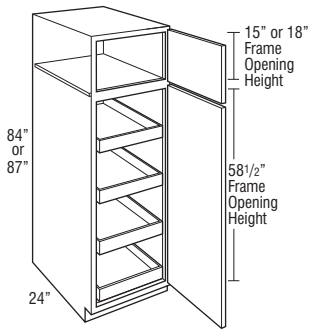

Price Point

	1	2	3	4	5	6	7	8
U128424RT L or R	1202	1315	1397	1430	1495	1511	1632	1693
U158424RT L or R	1211	1323	1405	1440	1506	1522	1645	1706
U188424RT L or R	1305	1431	1503	1544	1612	1630	1764	1832
U218424RT L or R	1399	1526	1604	1651	1720	1740	1883	1962
U248424RT L or R	1529	1653	1733	1792	1867	1888	2042	2126
U128724RT L or R	1226	1349	1420	1453	1520	1587	1697	1805
U158724RT L or R	1235	1359	1429	1462	1531	1598	1709	1820
U188724RT L or R	1330	1463	1536	1576	1650	1711	1835	1953
U218724RT L or R	1431	1561	1645	1688	1769	1823	1958	2085
U248724RT L or R	1564	1703	1784	1845	1925	1966	2115	2254

U248424BRT	1584	1717	1800	1863	1942	1963	2126	2214
U278424BRT	1712	1845	1934	2005	2087	2090	2303	2406
U308424BRT	1840	1973	2070	2146	2233	2250	2480	2593
U338424BRT	1900	2065	2119	2248	2291	2380	2563	2749
U368424BRT	1960	2156	2170	2349	2349	2507	2645	2906
U248724BRT	1623	1768	1855	1919	2003	2047	2204	2352
U278724BRT	1753	1903	2004	2071	2166	2214	2391	2553
U308724BRT	1884	2041	2154	2221	2327	2381	2581	2750
U338724BRT	1946	2144	2221	2339	2402	2512	2686	2904
U368724BRT	2008	2249	2288	2454	2476	2644	2795	3057

U129024RT L or R	1226	1349	1420	1453	1520	1587	1697	1805
U159024RT L or R	1235	1359	1429	1462	1531	1598	1709	1820
U189024RT L or R	1330	1463	1536	1576	1650	1711	1835	1953
U219024RT L or R	1431	1561	1645	1688	1769	1823	1958	2085
U249024RT L or R	1564	1703	1784	1845	1925	1966	2115	2254

U249024BRT	1623	1768	1855	1919	2003	2047	2204	2352
U279024BRT	1753	1903	2004	2071	2166	2214	2391	2553
U309024BRT	1884	2041	2154	2221	2327	2381	2581	2750
U339024BRT	1946	2144	2221	2339	2402	2512	2686	2904
U369024BRT	2008	2249	2288	2454	2476	2644	2795	3057

- 4 wood roll trays standard.
- One adjustable shelf included on 90" tall.
- Depth can be reduced to a minimum of 18".
- Tall mitered door styles and PureStyle™ door styles will feature one center panel, other door styles will feature two center panels.

Modifications

ACS	AUTH	CBO	CCO	CFNTO	CFRMO	CND	EX	FB	FDRW	FPEB	FTK	FTK_V	FULL/MFO	MI	NSCH	RD	RECTKL/R	RT	VTK	
•	•	•	•	•	•	•	•	•	•	•	•	•*	•	•	•	•	•	•	•	•

*FTKAV/FTKRV not available on U128424RT, U128724RT, and U129024RT.

Construction Upgrades

APU	PEU
•	•

Decorative Door Options

CG
•

**Utility with Roll Trays,
93" or 96" Tall, 24" Deep**

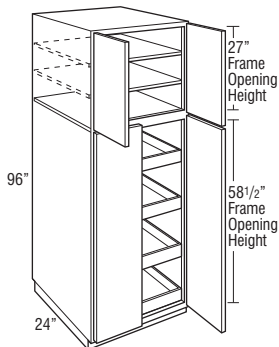
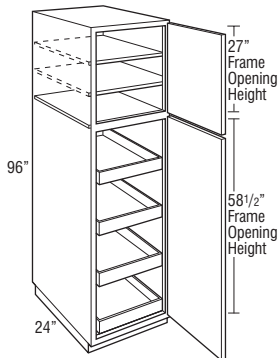
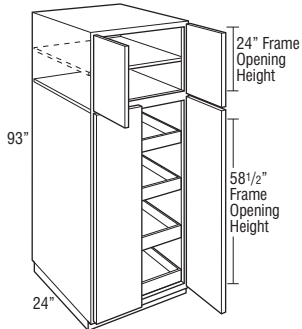
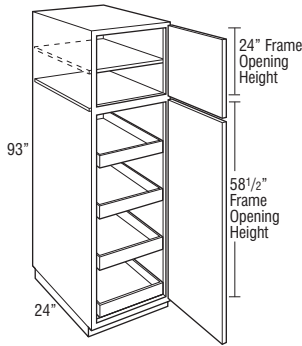

Price Point	1	2	3	4	5	6	7	8
U129324RT L or R	1255	1369	1450	1473	1549	1675	1762	1907
U159324RT L or R	1262	1378	1460	1485	1561	1686	1775	1921
U189324RT L or R	1365	1488	1570	1606	1687	1802	1899	2065
U219324RT L or R	1462	1598	1682	1726	1809	1925	2033	2206
U249324RT L or R	1600	1747	1839	1894	1982	2077	2193	2386

U249324BRT	1660	1815	1913	1970	2062	2164	2286	2488
U279324BRT	1793	1963	2071	2134	2237	2343	2479	2701
U309324BRT	1926	2111	2228	2298	2411	2523	2674	2911
U339324BRT	2010	2217	2292	2416	2480	2627	2787	3039
U369324BRT	2093	2321	2355	2533	2552	2735	2902	3169

U129624RT L or R	1255	1369	1450	1473	1549	1675	1762	1907
U159624RT L or R	1262	1378	1460	1485	1561	1686	1775	1921
U189624RT L or R	1365	1488	1570	1606	1687	1802	1899	2065
U219624RT L or R	1462	1598	1682	1726	1809	1925	2033	2206
U249624RT L or R	1600	1747	1839	1894	1982	2077	2193	2386

U249624BRT	1660	1815	1913	1970	2062	2164	2286	2488
U279624BRT	1793	1963	2071	2134	2237	2343	2479	2701
U309624BRT	1926	2111	2228	2298	2411	2523	2674	2911
U339624BRT	2010	2217	2292	2416	2480	2627	2787	3039
U369624BRT	2093	2321	2355	2533	2552	2735	2902	3169

- Toekick assembly shipped unattached, unless FTK options are selected.
- 4 wood roll trays standard.
- One adjustable shelf included on 93" tall.
- Two adjustable shelves included on 96" tall.
- Depth can be reduced to a minimum of 18".
- Tall mitered door styles and PureStyle™ door styles will feature one center panel, other door styles will feature two center panels.

Modifications

ACS	AUTH	CBO	CCO	CFNTO	CFRMO	CND	EX	FB	FDRW	FPEB	FTK	FTK_V	FULL/MFO	MI	NSCH	RD	RECTKL/R	RT	VTK	
•	•	•	•	•	•	•	•	•	•	•	•*	•	•	•	•	•	•	•	•	STD

*FTKAV/FTKFV not available on U129324RT and U129624RT.

Construction Upgrades

APU	PEU
•	•

Decorative Door Options

CG
•

Single Oven Cabinet, 84", 87", 90", 93", or 96" Tall, **NEW** 24" Deep

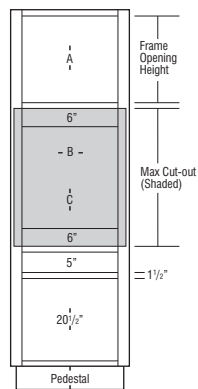
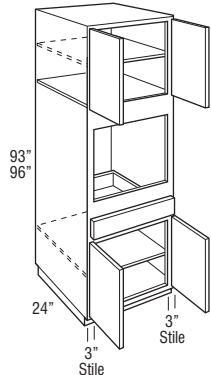
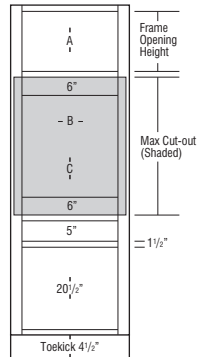
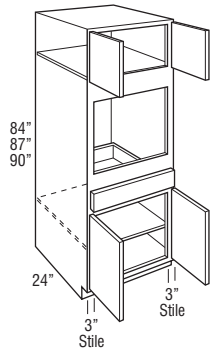

Price Point	1	2	3	4	5	6	7	8
OSB3084	1569	1743	1751	1914	1918	1947	2160	2275
NEW OSB31.584	1626	1819	1841	2010	2024	2063	2265	2389
OSB3384	1683	1895	1931	2105	2129	2178	2370	2502
OSB3087	1828	1879	1940	2075	2158	2196	2365	2606
NEW OSB31.587	1909	1968	2028	2171	2259	2315	2485	2749
OSB3387	1990	2056	2116	2266	2359	2433	2605	2892
OSB3090	1828	1879	1940	2075	2158	2196	2365	2606
NEW OSB31.590	1909	1968	2028	2171	2259	2315	2485	2749
OSB3390	1990	2056	2116	2266	2359	2433	2605	2892
OSB3093	1863	1980	1986	2180	2216	2308	2492	2745
NEW OSB31.593	1947	2071	2078	2279	2314	2427	2624	2884
OSB3393	2031	2161	2169	2378	2412	2545	2755	3022
OSB3096	1863	1980	1986	2180	2216	2308	2492	2745
NEW OSB31.596	1947	2071	2078	2279	2314	2427	2624	2884
OSB3396	2031	2161	2169	2378	2412	2545	2755	3022

- Uses face mount hinges, doors and drawer fronts have a consistent width reveal for full/modified full overlay (1/4") and traditional overlay (1").
- Base section will utilize a full depth shelf.
- 90", 93", and 96" tall include full depth adjustable shelves in upper section:
90" and 93" tall - one shelf
96" tall - two shelves
- Toe kick assembly shipped unattached on 93" and 96", unless FTK options are selected.
- Oven cavity is standard interior.
- All top and bottom cross rails are 1 1/2" wide.
- All cabinets have 3" stiles on frame.
- Be sure to confirm a heat shield is built into your appliance by the manufacturer or install the heat shield included with your appliance. Heat shields are sold separately as an accessory.
- Depth can be reduced to a minimum of 18".
- Oven Installation Kit included for 24" deep cabinets and has a 400 lb. weight limit.
- Maximum cut-out dimension will allow 1/4" reveal for doors and drawer fronts on full/modified full overlay and 1" for traditional overlay for trim kit face clearance.

	A Frame Opening Height	B Cut-out Width		C Cut-out Height		Door Height (Upper Section)		
		Min.	Max.	Min.	Max.	Traditional Overlay	Full Overlay	Modified Full Overlay
OSB3084	15"	24"	28 1/2"	22 1/2"	31 1/2"	16"	17 1/2"	16 3/4"
OSB31.584	15"	25 1/2"	30"	22 1/2"	31 1/2"	16"	17 1/2"	16 3/4"
OSB3384	15"	27"	31 1/2"	22 1/2"	31 1/2"	16"	17 1/2"	16 3/4"
OSB3087	18"	24"	28 1/2"	22 1/2"	31 1/2"	19"	20 1/2"	19 3/4"
OSB31.587	18"	25 1/2"	30"	22 1/2"	31 1/2"	19"	20 1/2"	19 3/4"
OSB3387	18"	27"	31 1/2"	22 1/2"	31 1/2"	19"	20 1/2"	19 3/4"
OSB3090	21"	24"	28 1/2"	22 1/2"	31 1/2"	22"	23 1/2"	22 3/4"
OSB31.590	21"	25 1/2"	30"	22 1/2"	31 1/2"	22"	23 1/2"	22 3/4"
OSB3390	21"	27"	31 1/2"	22 1/2"	31 1/2"	22"	23 1/2"	22 3/4"
OSB3093	24"	24"	28 1/2"	22 1/2"	31 1/2"	25"	26 1/2"	25 3/4"
OSB31.593	24"	25 1/2"	30"	22 1/2"	31 1/2"	25"	26 1/2"	25 3/4"
OSB3393	24"	27"	31 1/2"	22 1/2"	31 1/2"	25"	26 1/2"	25 3/4"
OSB3096	27"	24"	28 1/2"	22 1/2"	31 1/2"	28"	29 1/2"	28 3/4"
OSB31.596	27"	25 1/2"	30"	22 1/2"	31 1/2"	28"	29 1/2"	28 3/4"
OSB3396	27"	27"	31 1/2"	22 1/2"	31 1/2"	28"	29 1/2"	28 3/4"

Modifications

ACS	AUTH	CBO	CCO	CFNT0	CFRMO	CND	EX	FB	FDRW	FPEB	FTK	FTK_V	FULL/MFO	MI	NSCH	RD	RECTKL/R	RT	VTK
•	•	•	•	•	•	•	•	•	•	•	•	•	•	•	•	•	•*	•	•*

*RECTKL/R and VTK not available on 93" and 96" high cabinets.

Construction Upgrades

APU	PEU
•	•

Decorative Door Options

CG
•

**Single Oven Cabinet, Narrow Rail,
84", 87", 90", 93", or 96" Tall, ^{NEW}
24" Deep**

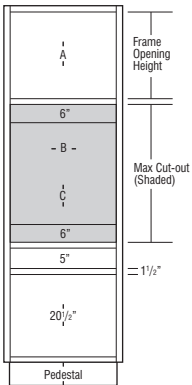
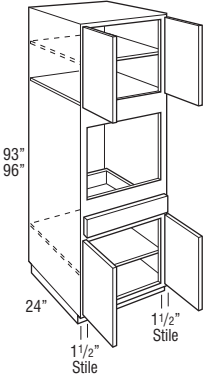
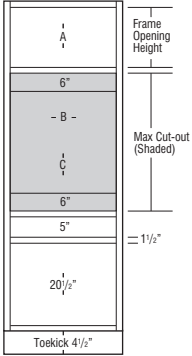
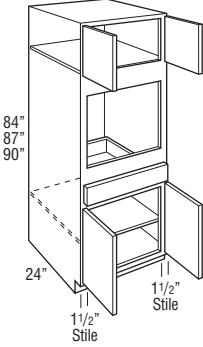

Price Point

	1	2	3	4	5	6	7	8
OSB3084N	1569	1743	1751	1914	1918	1947	2160	2275
OSB31.584N	1626	1819	1841	2010	2024	2063	2265	2389
OSB3384N	1683	1895	1931	2105	2129	2178	2370	2502
OSB3087N	1828	1879	1940	2075	2158	2196	2365	2606
^{NEW} OSB31.587N	1909	1968	2028	2171	2259	2315	2485	2749
OSB3387N	1990	2056	2116	2266	2359	2433	2605	2892
OSB3090N	1828	1879	1940	2075	2158	2196	2365	2606
^{NEW} OSB31.590N	1909	1968	2028	2171	2259	2315	2485	2749
OSB3390N	1990	2056	2116	2266	2359	2433	2605	2892
OSB3093N	1863	1980	1986	2180	2216	2308	2492	2745
^{NEW} OSB31.593N	1947	2071	2078	2279	2314	2427	2624	2884
OSB3393N	2031	2161	2169	2378	2412	2545	2755	3022
OSB3096N	1863	1980	1986	2180	2216	2308	2492	2745
^{NEW} OSB31.596N	1947	2071	2078	2279	2314	2427	2624	2884
OSB3396N	2031	2161	2169	2378	2412	2545	2755	3022

- Base section will utilize a full depth shelf.
- 90", 93", and 96" tall include full depth adjustable shelves in upper section:
90" and 93" tall - one shelf
96" tall - two shelves
- Toekick assembly shipped unattached on 93" and 96", unless FTK options are selected.
- Oven cavity is standard interior.
- All top and bottom cross rails are 1 1/2" wide.
- Be sure to confirm a heat shield is built into your appliance by the manufacturer or install the heat shield included with your appliance. Heat shields are sold separately as an accessory.
- Depth can be reduced to a minimum of 18".
- Oven Installation Kit included for 24" deep cabinets and has a 400 lb. weight limit.
- Maximum cut-out dimension will allow 1/4" reveal for doors and drawer fronts on full/modified full overlay and 1" for traditional overlay for trim kit face clearance.

	A Frame Opening Height	B Cut-out Width (standard)		B Cut-out Width (with ACS modification)			C Cut-out Height		Door Height (Upper Section)		
		Min.	Max.	Min.	Max.	Max. w/ Field Cut	Min.	Max.	Traditional Overlay	Full Overlay	Modified Full Overlay
OSB3084N	15"	27"	28 1/2"	24"	27"	28 1/2"	22 1/2"	31 1/2"	16"	17 1/2"	16 3/4"
OSB31.584N	15"	28 1/2"	30"	25 1/2"	28 1/2"	30"	22 1/2"	31 1/2"	16"	17 1/2"	16 3/4"
OSB3384N	15"	30"	31 1/2"	27"	30"	31 1/2"	22 1/2"	31 1/2"	16"	17 1/2"	16 3/4"
OSB3087N	18"	27"	28 1/2"	24"	27"	28 1/2"	22 1/2"	31 1/2"	19"	20 1/2"	19 3/4"
OSB31.587N	18"	28 1/2"	30"	25 1/2"	28 1/2"	30"	22 1/2"	31 1/2"	19"	20 1/2"	19 3/4"
OSB3387N	18"	30"	31 1/2"	27"	30"	31 1/2"	22 1/2"	31 1/2"	19"	20 1/2"	19 3/4"
OSB3090N	21"	27"	28 1/2"	24"	27"	28 1/2"	22 1/2"	31 1/2"	22"	23 1/2"	22 3/4"
OSB31.590N	21"	28 1/2"	30"	25 1/2"	28 1/2"	30"	22 1/2"	31 1/2"	22"	23 1/2"	22 3/4"
OSB3390N	21"	30"	31 1/2"	27"	30"	31 1/2"	22 1/2"	31 1/2"	22"	23 1/2"	22 3/4"
OSB3093N	24"	27"	28 1/2"	24"	27"	28 1/2"	22 1/2"	31 1/2"	25"	26 1/2"	25 3/4"
OSB31.593N	24"	28 1/2"	30"	25 1/2"	28 1/2"	30"	22 1/2"	31 1/2"	25"	26 1/2"	25 3/4"
OSB3393N	24"	30"	31 1/2"	27"	30"	31 1/2"	22 1/2"	31 1/2"	25"	26 1/2"	25 3/4"
OSB3096N	27"	27"	28 1/2"	24"	27"	28 1/2"	22 1/2"	31 1/2"	28"	29 1/2"	28 3/4"
OSB31.596N	27"	28 1/2"	30"	25 1/2"	28 1/2"	30"	22 1/2"	31 1/2"	28"	29 1/2"	28 3/4"
OSB3396N	27"	30"	31 1/2"	27"	30"	31 1/2"	22 1/2"	31 1/2"	28"	29 1/2"	28 3/4"

Modifications

ACS	AUTH	CBO	CCO	CFNT0	CFRMO	CND	EX	FB	FDRW	FPFB	FTK	FTK_V	FULL/MFO	MI	NSCH	RD	RECTKL/R	RT	VTK
•	•	•	•	•	•	•	•	•	•	•	•	•	•	•	•	•	•*	•	•*

*RECTKL/R and VTK not available on 93" and 96" high cabinets.

Construction Upgrades

APU	PEU
•	•

Decorative Door Options

CG
•

Double Oven Cabinet, 84", 87", 90", 93", or 96" Tall, 24" Deep

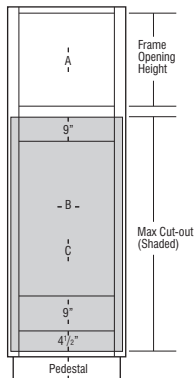
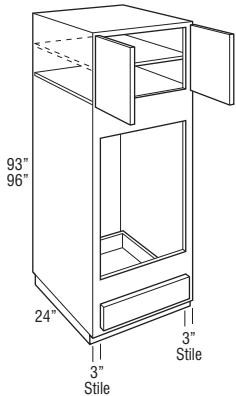
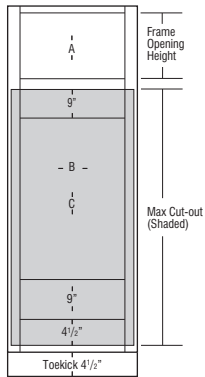
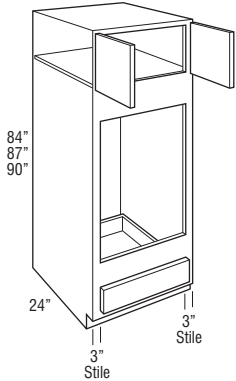

Price Point	1	2	3	4	5	6	7	8
OD3084	1298	1440	1447	1583	1586	1610	1785	1880
NEW OD31.584	1345	1502	1521	1661	1673	1705	1871	1974
OD3384	1391	1564	1594	1739	1759	1799	1957	2067
OD3087	1510	1554	1602	1714	1783	1815	1953	2155
NEW OD31.587	1578	1627	1675	1793	1866	1913	2054	2273
OD3387	1645	1700	1748	1871	1949	2010	2154	2390
OD3090	1510	1554	1602	1714	1783	1815	1953	2155
NEW OD31.590	1578	1627	1675	1793	1866	1913	2054	2273
OD3390	1645	1700	1748	1871	1949	2010	2154	2390
OD3093	1538	1638	1641	1800	1832	1908	2060	2269
NEW OD31.593	1608	1712	1716	1883	1913	2005	2168	2384
OD3393	1677	1786	1791	1965	1994	2102	2276	2498
OD3096	1538	1638	1641	1800	1832	1908	2060	2269
NEW OD31.596	1608	1712	1716	1883	1913	2005	2168	2384
OD3396	1677	1786	1791	1965	1994	2102	2276	2498

- Uses face mount hinges, doors and drawer fronts have a consistent width reveal for full/modified full overlay (1/4") and traditional overlay (1").
- 90", 93", and 96" tall include full depth adjustable shelves in upper section:
90" and 93" tall - one shelf
96" tall - two shelves
- Toekick assembly shipped unattached on 93" and 96", unless FTK options are selected.
- Oven cavity is standard interior.
- For built-in double oven applications, remove drawer as needed.
- All top and bottom cross rails are 1 1/2" wide.
- All cabinets have 3" stiles on frame.
- Be sure to confirm a heat shield is built into your appliance by the manufacturer or install the heat shield included with your appliance. Heat shields are sold separately as an accessory.
- Depth can be reduced to a minimum of 18".
- Oven Installation Kit included for 24" deep cabinets and has a 400 lb. weight limit.
- Oven cabinets feature an open back in cut-out area designed to improve field appliance installation.
- Maximum cut-out dimension will allow 1/4" reveal for doors and drawer fronts on full/modified full overlay and 1" for traditional overlay for trim kit face clearance.

	A Frame Opening Height	B Cut-out Width		C Cut-out Height		Door Height (Upper Section)		
		Min.	Max.	Min.	Max.	Traditional Overlay	Full Overlay	Modified Full Overlay
OD3084	15"	24"	28 1/2"	39"	60"	16"	17 1/2"	16 3/4"
OD31.584	15"	25 1/2"	30"	39"	60"	16"	17 1/2"	16 3/4"
OD3384	15"	27"	31 1/2"	39"	60"	16"	17 1/2"	16 3/4"
OD3087	18"	24"	28 1/2"	39"	60"	19"	20 1/2"	19 3/4"
OD31.587	18"	25 1/2"	30"	39"	60"	19"	20 1/2"	19 3/4"
OD3387	18"	27"	31 1/2"	39"	60"	19"	20 1/2"	19 3/4"
OD3090	21"	24"	28 1/2"	39"	60"	22"	23 1/2"	22 3/4"
OD31.590	21"	25 1/2"	30"	39"	60"	22"	23 1/2"	22 3/4"
OD3390	21"	27"	31 1/2"	39"	60"	22"	23 1/2"	22 3/4"
OD3093	24"	24"	28 1/2"	39"	60"	25"	26 1/2"	25 3/4"
OD31.593	24"	25 1/2"	30"	39"	60"	25"	26 1/2"	25 3/4"
OD3393	24"	27"	31 1/2"	39"	60"	25"	26 1/2"	25 3/4"
OD3096	27"	24"	28 1/2"	39"	60"	28"	29 1/2"	28 3/4"
OD31.596	27"	25 1/2"	30"	39"	60"	28"	29 1/2"	28 3/4"
OD3396	27"	27"	31 1/2"	39"	60"	28"	29 1/2"	28 3/4"

Modifications

ACS	AUTH	CBO	CCO	CFNTO	CFRMO	CND	EX	FB	FDRW	FPEB	FTK	FTK_V	FULL/MFO	MI	NSCH	RD	RECTKL/R	RT	VTK
•	•	•	•	•	•	•	•	•	•	•	•	•	•	•	•	•	•*	•	•*

*RECTKL/R and VTK not available on 93" and 96" high cabinets.

Construction Upgrades

APU	PEU
•	•

Decorative Door Options

CG
•

Double Oven Cabinet, Narrow Rail, 84", 87", 90", 93", or 96" Tall, 24" Deep

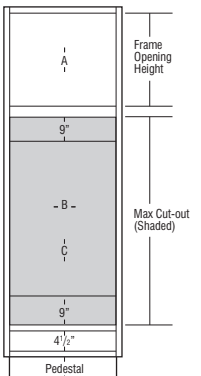
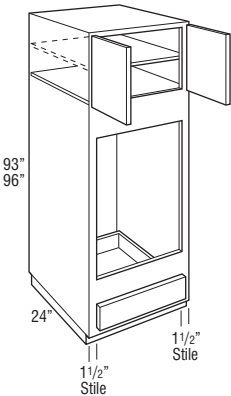
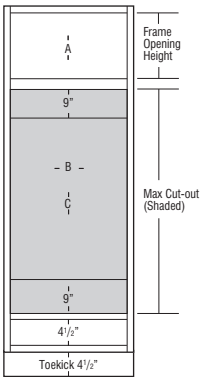
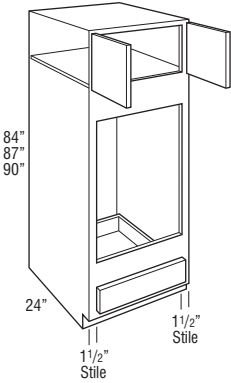

	1	2	3	4	5	6	7	8
OD3084N	1298	1440	1447	1583	1586	1610	1785	1880
NEW OD31.584N	1345	1502	1521	1661	1673	1705	1871	1974
OD3384N	1391	1564	1594	1739	1759	1799	1957	2067
OD3087N	1510	1554	1602	1714	1783	1815	1953	2155
NEW OD31.587N	1578	1627	1675	1793	1866	1913	2054	2273
OD3387N	1645	1700	1748	1871	1949	2010	2154	2390
OD3090N	1510	1554	1602	1714	1783	1815	1953	2155
NEW OD31.590N	1578	1627	1675	1793	1866	1913	2054	2273
OD3390N	1645	1700	1748	1871	1949	2010	2154	2390
OD3093N	1538	1638	1641	1800	1832	1908	2060	2269
NEW OD31.593N	1608	1712	1716	1883	1913	2005	2168	2384
OD3393N	1677	1786	1791	1965	1994	2102	2276	2498
OD3096N	1538	1638	1641	1800	1832	1908	2060	2269
NEW OD31.596N	1608	1712	1716	1883	1913	2005	2168	2384
OD3396N	1677	1786	1791	1965	1994	2102	2276	2498

- 90", 93", and 96" tall include full depth adjustable shelves in upper section:
90" and 93" tall - one shelf
96" tall - two shelves
- ToeKick assembly shipped unattached on 93" and 96", unless FTK options are selected.
- Oven cavity is standard interior.
- For built-in double oven applications, remove drawer as needed.
- All top and bottom cross rails are 1 1/2" wide.
- Be sure to confirm a heat shield is built into your appliance by the manufacturer or install the heat shield included with your appliance. Heat shields are sold separately as an accessory.
- Depth can be reduced to a minimum of 18".
- Oven Installation Kit included for 24" deep cabinets and has a 400 lb. weight limit.
- Oven cabinets feature an open back in cut-out area designed to improve field appliance installation.
- Maximum cut-out dimension will allow 1/4" reveal for doors and drawer fronts on full/modified full overlay and 1" for traditional overlay for trim kit face clearance.

	A Frame Opening Height	B Cut-out Width (standard)		B Cut-out Width (with ACS modification)			C Cut-out Height		Door Height (Upper Section)		
		Min.	Max.	Min.	Max.	Max. w/ Field Cut	Min.	Max.	Traditional Overlay	Full Overlay	Modified Full Overlay
OD3084N	15"	27"	28 1/2"	24"	27"	28 1/2"	39"	54"	16"	17 1/2"	16 3/4"
OD31.584N	15"	28 1/2"	30"	25 1/2"	28 1/2"	30"	39"	54"	16"	17 1/2"	16 3/4"
OD3384N	15"	30"	31 1/2"	27"	30"	31 1/2"	39"	54"	16"	17 1/2"	16 3/4"
OD3087N	18"	27"	28 1/2"	24"	27"	28 1/2"	39"	54"	19"	20 1/2"	19 3/4"
OD31.587N	18"	28 1/2"	30"	25 1/2"	28 1/2"	30"	39"	54"	19"	20 1/2"	19 3/4"
OD3387N	18"	30"	31 1/2"	27"	30"	31 1/2"	39"	54"	19"	20 1/2"	19 3/4"
OD3090N	21"	27"	28 1/2"	24"	27"	28 1/2"	39"	54"	22"	23 1/2"	22 3/4"
OD31.590N	21"	28 1/2"	30"	25 1/2"	28 1/2"	30"	39"	54"	22"	23 1/2"	22 3/4"
OD3390N	21"	30"	31 1/2"	27"	30"	31 1/2"	39"	54"	22"	23 1/2"	22 3/4"
OD3093N	24"	27"	28 1/2"	24"	27"	28 1/2"	39"	54"	25"	26 1/2"	25 3/4"
OD31.593N	24"	28 1/2"	30"	25 1/2"	28 1/2"	30"	39"	54"	25"	26 1/2"	25 3/4"
OD3393N	24"	30"	31 1/2"	27"	30"	31 1/2"	39"	54"	25"	26 1/2"	25 3/4"
OD3096N	27"	27"	28 1/2"	24"	27"	28 1/2"	39"	54"	28"	29 1/2"	28 3/4"
OD31.596N	27"	28 1/2"	30"	25 1/2"	28 1/2"	30"	39"	54"	28"	29 1/2"	28 3/4"
OD3396N	27"	30"	31 1/2"	27"	30"	31 1/2"	39"	54"	28"	29 1/2"	28 3/4"

Modifications

ACS	AUTH	CBO	CCO	CFNTD	CFRMO	CND	EX	FB	FDRW	FPEB	FTK	FTK_V	FULL/MFO	MI	NSCH	RD	RECTKL/R	RT	VTK
•	•	•	•	•	•	•	•	•	•	•	•	•	•	•	•	•	•*	•	•*

*RECTKL/R and VTK not available on 93" and 96" high cabinets.

Construction Upgrades

APU	PEU
•	•

Decorative Door Options

CG
•

Double Oven Cabinet, Deep Drawer, 84", 87", 90", 93", or 96" Tall, ^{NEW} 24" Deep

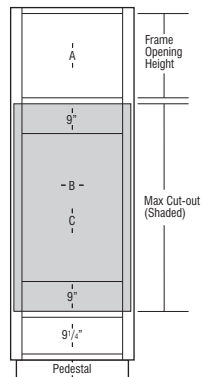
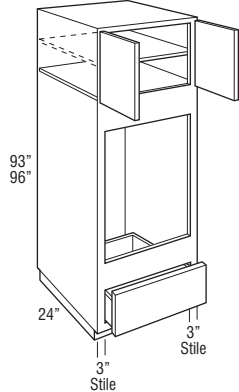
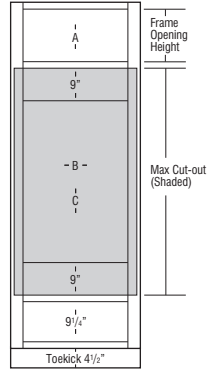
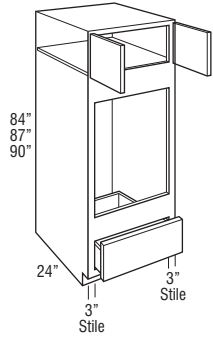

Price Point	1	2	3	4	5	6	7	8
OD3084DD	1402	1555	1563	1710	1713	1739	1928	2030
OD31.584DD	1452	1622	1643	1794	1807	1841	2021	2131
OD3384DD	1502	1689	1722	1878	1900	1943	2114	2232
OD3087DD	1631	1678	1730	1851	1926	1960	2109	2327
^{NEW} OD31.587DD	1704	1757	1809	1936	2016	2066	2218	2454
OD3387DD	1777	1836	1888	2021	2105	2171	2326	2581
OD3090DD	1631	1678	1730	1851	1926	1960	2109	2327
^{NEW} OD31.590DD	1704	1757	1809	1936	2016	2066	2218	2454
OD3390DD	1777	1836	1888	2021	2105	2171	2326	2581
OD3093DD	1661	1769	1772	1944	1979	2061	2225	2451
^{NEW} OD31.593DD	1736	1849	1853	2033	2067	2166	2342	2575
OD3393DD	1811	1929	1934	2122	2154	2270	2458	2698
OD3096DD	1661	1769	1772	1944	1979	2061	2225	2451
^{NEW} OD31.596DD	1736	1849	1853	2033	2067	2166	2342	2575
OD3396DD	1811	1929	1934	2122	2154	2270	2458	2698

- Uses face mount hinges, doors and drawer fronts have a consistent width reveal for full/modified full overlay (1/4") and traditional overlay (1").
- On 93" and 96" tall, one full depth adjustable shelf included.
- Toekick assembly shipped unattached on 93" and 96", unless FTK options are selected.
- Oven cavity is standard interior.
- All top and bottom cross rails are 1 1/2" wide.
- All cabinets have 3" stiles on frame.
- Be sure to confirm a heat shield is built into your appliance by the manufacturer or install the heat shield included with your appliance. Heat shields are sold separately as an accessory.
- Depth can be reduced to a minimum of 18".
- Oven Installation Kit included for 24" deep cabinets and has a 400 lb. weight limit.
- Oven cabinets feature an open back in cut-out area designed to improve field appliance installation.
- Maximum cut-out dimension will allow 1/4" reveal for doors and drawer fronts on full/modified full overlay and 1" for traditional overlay for trim kit face clearance.

	A		B		C		Door Height (Upper Section)		
	Frame Opening Height	Cut-out Width		Cut-out Height		Traditional Overlay	Full Overlay	Modified Full Overlay	
		Min.	Max.	Min.	Max.				
OD3084DD	12"	24"	28 1/2"	37 1/4"	52 1/4"	13"	14 1/2"	13 3/4"	
OD31.584DD	12"	25 1/2"	30"	37 1/4"	52 1/4"	13"	14 1/2"	13 3/4"	
OD3384DD	12"	27"	31 1/2"	37 1/4"	52 1/4"	13"	14 1/2"	13 3/4"	
OD3087DD	15"	24"	28 1/2"	37 1/4"	52 1/4"	16"	17 1/2"	16 3/4"	
OD31.587DD	15"	25 1/2"	30"	37 1/4"	52 1/4"	16"	17 1/2"	16 3/4"	
OD3387DD	15"	27"	31 1/2"	37 1/4"	52 1/4"	16"	17 1/2"	16 3/4"	
OD3090DD	18"	24"	28 1/2"	37 1/4"	52 1/4"	19"	20 1/2"	19 3/4"	
OD31.590DD	18"	25 1/2"	30"	37 1/4"	52 1/4"	19"	20 1/2"	19 3/4"	
OD3390DD	18"	27"	31 1/2"	37 1/4"	52 1/4"	19"	20 1/2"	19 3/4"	
OD3093DD	21"	24"	28 1/2"	37 1/4"	52 1/4"	22"	23 1/2"	22 3/4"	
OD31.593DD	21"	25 1/2"	30"	37 1/4"	52 1/4"	22"	23 1/2"	22 3/4"	
OD3393DD	21"	27"	31 1/2"	37 1/4"	52 1/4"	22"	23 1/2"	22 3/4"	
OD3096DD	24"	24"	28 1/2"	37 1/4"	52 1/4"	25"	26 1/2"	25 3/4"	
OD31.596DD	24"	25 1/2"	30"	37 1/4"	52 1/4"	25"	26 1/2"	25 3/4"	
OD3396DD	24"	27"	31 1/2"	37 1/4"	52 1/4"	25"	26 1/2"	25 3/4"	

Modifications

ACS	AUTH	CBO	CCO	CFNTO	CFRMO	CND	EX	FB	FDRW	FPEB	FTK	FTK_V	FULL/MFO	MI	NSCH	RD	RECTKL/R	RT	VTK
•	•	•	•	•	•	•	•	•	•	•	•	•	•	•	•	•	•*	•	•*

*RECTKL/R and VTK not available on 93" and 96" high cabinets.

Construction Upgrades

APU	PEU
•	•

Decorative Door Options

CG
•

Double Oven Cabinet, Deep Drawer, Narrow Rail, 84", 87", 90", 93", or 96" Tall, 24" Deep

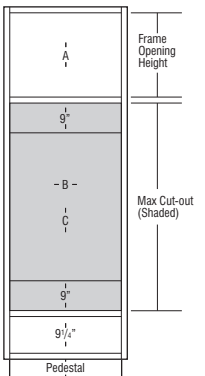
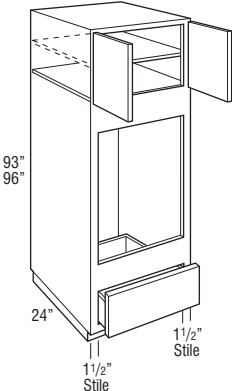
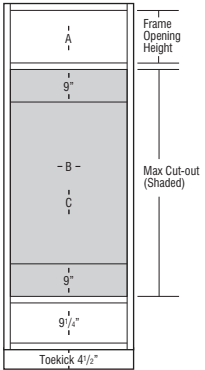
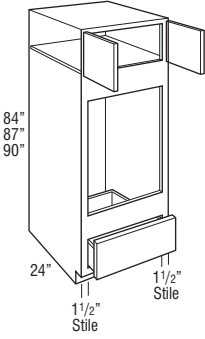

	1	2	3	4	5	6	7	8
OD3084DDN	1402	1555	1563	1710	1713	1739	1928	2030
NEW OD31.584DDN	1452	1622	1643	1794	1807	1841	2021	2131
OD3384DDN	1502	1689	1722	1878	1900	1943	2114	2232
OD3087DDN	1631	1678	1730	1851	1926	1960	2109	2327
NEW OD31.587DDN	1704	1757	1809	1936	2016	2066	2218	2454
OD3387DDN	1777	1836	1888	2021	2105	2171	2326	2581
OD3090DDN	1631	1678	1730	1851	1926	1960	2109	2327
NEW OD31.590DDN	1704	1757	1809	1936	2016	2066	2218	2454
OD3390DDN	1777	1836	1888	2021	2105	2171	2326	2581
OD3093DDN	1661	1769	1772	1944	1979	2061	2225	2451
NEW OD31.593DDN	1736	1849	1853	2033	2067	2166	2342	2575
OD3393DDN	1811	1929	1934	2122	2154	2270	2458	2698
OD3096DDN	1661	1769	1772	1944	1979	2061	2225	2451
NEW OD31.596DDN	1736	1849	1853	2033	2067	2166	2342	2575
OD3396DDN	1811	1929	1934	2122	2154	2270	2458	2698

- On 93" and 96" tall, one full depth adjustable shelf included.
- Toekick assembly shipped unattached on 93" and 96", unless FTK options are selected.
- Oven cavity is standard interior.
- All top and bottom cross rails are 1 1/2" wide.
- Be sure to confirm a heat shield is built into your appliance by the manufacturer or install the heat shield included with your appliance. Heat shields are sold separately as an accessory.
- Depth can be reduced to a minimum of 18".
- Oven Installation Kit included for 24" deep cabinets and has a 400 lb. weight limit.
- Oven cabinets feature an open back in cut-out area designed to improve field appliance installation.
- Maximum cut-out dimension will allow 1/4" reveal for doors and drawer fronts on full/modified full overlay and 1" for traditional overlay for trim kit face clearance.

	A Frame Opening Height	B Cut-out Width (standard)		B Cut-out Width (with ACS modification)			C Cut-out Height		Door Height (Upper Section)		
		Min.	Max.	Min.	Max.	Max. w/ Field Cut	Min.	Max.	Traditional Overlay	Full Overlay	Modified Full Overlay
OD3084DDN	12"	27"	28 1/2"	24"	27"	28 1/2"	37 1/4"	52 1/4"	13"	14 1/2"	13 3/4"
OD31.584DDN	12"	28 1/2"	30"	25 1/2"	28 1/2"	30"	37 1/4"	52 1/4"	13"	14 1/2"	13 3/4"
OD3384DDN	12"	30"	31 1/2"	27"	30"	31 1/2"	37 1/4"	52 1/4"	13"	14 1/2"	13 3/4"
OD3087DDN	15"	27"	28 1/2"	24"	27"	28 1/2"	37 1/4"	52 1/4"	16"	17 1/2"	16 3/4"
OD31.587DDN	15"	28 1/2"	30"	25 1/2"	28 1/2"	30"	37 1/4"	52 1/4"	16"	17 1/2"	16 3/4"
OD3387DDN	15"	30"	31 1/2"	27"	30"	31 1/2"	37 1/4"	52 1/4"	16"	17 1/2"	16 3/4"
OD3090DDN	18"	27"	28 1/2"	24"	27"	28 1/2"	37 1/4"	52 1/4"	19"	20 1/2"	19 3/4"
OD31.590DDN	18"	28 1/2"	30"	25 1/2"	28 1/2"	30"	37 1/4"	52 1/4"	19"	20 1/2"	19 3/4"
OD3390DDN	18"	30"	31 1/2"	27"	30"	31 1/2"	37 1/4"	52 1/4"	19"	20 1/2"	19 3/4"
OD3093DDN	21"	27"	28 1/2"	24"	27"	28 1/2"	37 1/4"	52 1/4"	22"	23 1/2"	22 3/4"
OD31.593DDN	21"	28 1/2"	30"	25 1/2"	28 1/2"	30"	37 1/4"	52 1/4"	22"	23 1/2"	22 3/4"
OD3393DDN	21"	30"	31 1/2"	27"	30"	31 1/2"	37 1/4"	52 1/4"	22"	23 1/2"	22 3/4"
OD3096DDN	24"	27"	28 1/2"	24"	27"	28 1/2"	37 1/4"	52 1/4"	25"	26 1/2"	25 3/4"
OD31.596DDN	24"	28 1/2"	30"	25 1/2"	28 1/2"	30"	37 1/4"	52 1/4"	25"	26 1/2"	25 3/4"
OD3396DDN	24"	30"	31 1/2"	27"	30"	31 1/2"	37 1/4"	52 1/4"	25"	26 1/2"	25 3/4"

Modifications

ACS	AUTH	CBO	CCO	CFNTO	CFRMO	CND	EX	FB	FDRW	FPFB	FTK	FTK_V	FULL/MFO	MI	NSCH	RD	RECTKL/R	RT	VTK	
•	•	•	•	•	•	•	•	•	•	•	•	•	•	•	•	•	•	•	•	•

*RECTKL/R and VTK not available on 93" and 96" high cabinets.

Construction Upgrades

APU	PEU
•	•

Decorative Door Options

CG
•

Oven Microwave Cabinet, Deep Drawer, 84", 87", 90", 93", or 96" Tall, 24" Deep

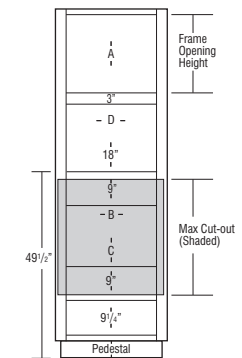
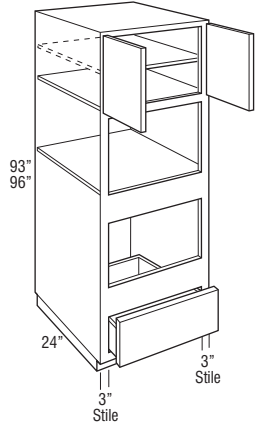
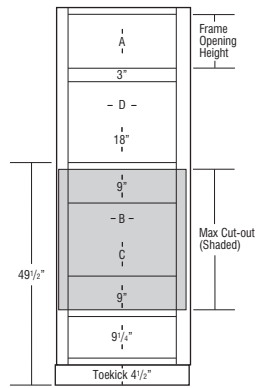
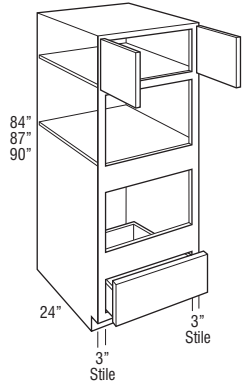

	Price Point	1	2	3	4	5	6	7	8
		1531	1689	1696	1845	1848	1875	2068	2173
NEW	OMC31.58424DD	1591	1766	1786	1939	1952	1988	2171	2284
	OMC338424DD	1650	1842	1875	2033	2055	2100	2274	2394
	OMC308724DD	1766	1813	1868	1991	2066	2101	2255	2474
NEW	OMC31.58724DD	1848	1901	1956	2086	2165	2216	2372	2612
	OMC338724DD	1929	1989	2043	2180	2264	2331	2488	2749
	OMC309024DD	1766	1813	1868	1991	2066	2101	2255	2474
NEW	OMC31.59024DD	1848	1901	1956	2086	2165	2216	2372	2612
	OMC339024DD	1929	1989	2043	2180	2264	2331	2488	2749
	OMC309324DD	1798	1905	1910	2086	2119	2203	2370	2600
NEW	OMC31.59324DD	1882	1995	2001	2184	2216	2318	2497	2734
	OMC339324DD	1966	2084	2091	2281	2312	2433	2624	2867
	OMC309624DD	1798	1905	1910	2086	2119	2203	2370	2600
NEW	OMC31.59624DD	1882	1995	2001	2184	2216	2318	2497	2734
	OMC339624DD	1966	2084	2091	2281	2312	2433	2624	2867

- Designed for use with separate built-in microwave above, built-in oven below. For built-in double ovens, see pages 122-125.
- Uses face mount hinges, doors and drawer fronts have a consistent width reveal for full/modified full overlay (1/4") and traditional overlay (1").
- On 93" and 96" tall, one full depth adjustable shelf included.
- Toekick assembly shipped unattached on 93" and 96", unless FTK options are selected.
- Oven cavity is standard interior.
- All top and bottom cross rails are 1 1/2" wide.
- All cabinets have 3" stiles on frame.
- Be sure to confirm a heat shield is built into your appliance by the manufacturer or install the heat shield included with your appliance. Heat shields are sold separately as an accessory.
- Depth can be reduced to a minimum of 18".
- Oven Installation Kit included for 24" deep cabinets and has a 400 lb. weight limit.
- Maximum cut-out dimension will allow 1/4" reveal for doors and drawer fronts on full/modified full overlay and 1" for traditional overlay for trim kit face clearance.

	A Frame Opening Height	B Cut-out Width		C Cut-out Height		D Frame Opening Width	Door Height (Upper Section)		
		Min.	Max.	Min.	Max.		Traditional Overlay	Full Overlay	Modified Full Overlay
OMC308424DD	12"	24"	28 1/2"	16 1/4"	31 1/4"	24"	13"	14 1/2"	13 3/4"
OMC31.58424DD	12"	25 1/2"	30"	16 1/4"	31 1/4"	25 1/2"	13"	14 1/2"	13 3/4"
OMC338424DD	12"	27"	31 1/2"	16 1/4"	31 1/4"	27"	13"	14 1/2"	13 3/4"
OMC308724DD	15"	24"	28 1/2"	16 1/4"	31 1/4"	24"	16"	17 1/2"	16 3/4"
OMC31.58724DD	15"	25 1/2"	30"	16 1/4"	31 1/4"	25 1/2"	16"	17 1/2"	16 3/4"
OMC338724DD	15"	27"	31 1/2"	16 1/4"	31 1/4"	27"	16"	17 1/2"	16 3/4"
OMC309024DD	18"	24"	28 1/2"	16 1/4"	31 1/4"	24"	19"	20 1/2"	19 3/4"
OMC31.59024DD	18"	25 1/2"	30"	16 1/4"	31 1/4"	25 1/2"	19"	20 1/2"	19 3/4"
OMC339024DD	18"	27"	31 1/2"	16 1/4"	31 1/4"	27"	19"	20 1/2"	19 3/4"
OMC309324DD	21"	24"	28 1/2"	16 1/4"	31 1/4"	24"	22"	23 1/2"	22 3/4"
OMC31.59324DD	21"	25 1/2"	30"	16 1/4"	31 1/4"	25 1/2"	22"	23 1/2"	22 3/4"
OMC339324DD	21"	27"	31 1/2"	16 1/4"	31 1/4"	27"	22"	23 1/2"	22 3/4"
OMC309624DD	24"	24"	28 1/2"	16 1/4"	31 1/4"	24"	25"	26 1/2"	25 3/4"
OMC31.59624DD	24"	25 1/2"	30"	16 1/4"	31 1/4"	25 1/2"	25"	26 1/2"	25 3/4"
OMC339624DD	24"	27"	31 1/2"	16 1/4"	31 1/4"	27"	25"	26 1/2"	25 3/4"

Modifications

ACS	AUTH	CBO	CCO	CFNTO	CFRMO	CND	EX	FB	FDRW	FPEB	FTK	FTK_V	FULL/MFO	MI	NSCH	RD	RECTKL/R	RT	VTK
•	•	•	•	•	•	•	•	•	•	•	•	•	•	•	•	•	•*	•	•*

*RECTKL/R and VTK not available on 93" and 96" high cabinets.

Construction Upgrades

APU	PEU
•	•

Decorative Door Options

CG

**Oven Microwave Cabinet,
Deep Drawer, Narrow Rail,
84", 87", 90", 93", or 96" Tall,
24" Deep**

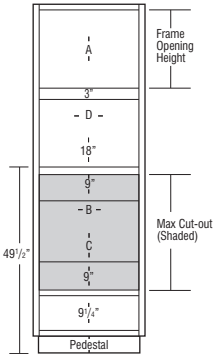
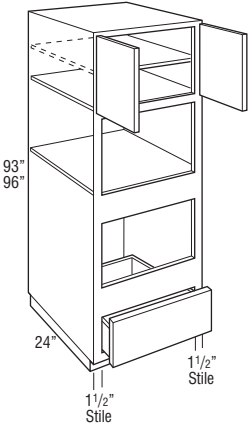
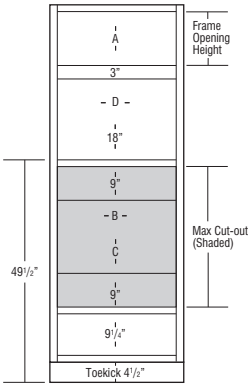
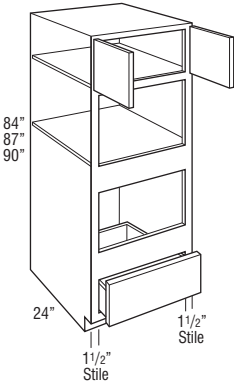

Price Point	1	2	3	4	5	6	7	8
OMC308424DDN	1531	1689	1696	1845	1848	1875	2068	2173
NEW OMC31.58424DDN	1591	1766	1786	1939	1952	1988	2171	2284
OMC338424DDN	1650	1842	1875	2033	2055	2100	2274	2394
OMC308724DDN	1766	1813	1868	1991	2066	2101	2255	2474
NEW OMC31.58724DDN	1848	1901	1956	2086	2165	2216	2372	2612
OMC338724DDN	1929	1989	2043	2180	2264	2331	2488	2749
OMC309024DDN	1766	1813	1868	1991	2066	2101	2255	2474
NEW OMC31.59024DDN	1848	1901	1956	2086	2165	2216	2372	2612
OMC339024DDN	1929	1989	2043	2180	2264	2331	2488	2749
OMC309324DDN	1798	1905	1910	2086	2119	2203	2370	2600
NEW OMC31.59324DDN	1882	1995	2001	2184	2216	2318	2497	2734
OMC339324DDN	1966	2084	2091	2281	2312	2433	2624	2867
OMC309624DDN	1798	1905	1910	2086	2119	2203	2370	2600
NEW OMC31.59624DDN	1882	1995	2001	2184	2216	2318	2497	2734
OMC339624DDN	1966	2084	2091	2281	2312	2433	2624	2867

- Designed for use with separate built-in microwave above, built-in oven below. For built-in double ovens, see pages 122-125.
- On 93" and 96" tall, one full depth adjustable shelf included.
- Toekick assembly shipped unattached on 93" and 96", unless FTK options are selected.
- Oven cavity is standard interior.
- All top and bottom cross rails are 1 1/2" wide.
- Be sure to confirm a heat shield is built into your appliance by the manufacturer or install the heat shield included with your appliance. Heat shields are sold separately as an accessory.
- Depth can be reduced to a minimum of 18".
- Oven Installation Kit included for 24" deep cabinets and has a 400 lb. weight limit.
- Maximum cut-out dimension will allow 1/4" reveal for doors and drawer fronts on full/modified full overlay and 1" for traditional overlay for trim kit face clearance.

	A Frame Opening Height	B Cut-out Width (standard)		B Cut-out Width (with ACS modification)			C Cut-out Height		D Frame Opening Width	Door Height (Upper Section)		
		Min.	Max.	Min.	Max.	Max. w/ Field Cut	Min.	Max.		Traditional Overlay	Full Overlay	Modified Full Overlay
OMC308424DDN	12"	27"	28 1/2"	24"	27"	28 1/2"	16 1/4"	31 1/4"	27"	13"	14 1/2"	13 3/4"
OMC31.58424DDN	12"	28 1/2"	30"	25 1/2"	28 1/2"	30"	16 1/4"	31 1/4"	28 1/2"	13"	14 1/2"	13 3/4"
OMC338424DDN	12"	30"	31 1/2"	27"	30"	31 1/2"	16 1/4"	31 1/4"	30"	13"	14 1/2"	13 3/4"
OMC308724DDN	15"	27"	28 1/2"	24"	27"	28 1/2"	16 1/4"	31 1/4"	27"	16"	17 1/2"	16 3/4"
OMC31.58724DDN	15"	28 1/2"	30"	25 1/2"	28 1/2"	30"	16 1/4"	31 1/4"	28 1/2"	16"	17 1/2"	16 3/4"
OMC338724DDN	15"	30"	31 1/2"	27"	30"	31 1/2"	16 1/4"	31 1/4"	30"	16"	17 1/2"	16 3/4"
OMC309024DDN	18"	27"	28 1/2"	24"	27"	28 1/2"	16 1/4"	31 1/4"	27"	19"	20 1/2"	19 3/4"
OMC31.59024DDN	18"	28 1/2"	30"	25 1/2"	28 1/2"	30"	16 1/4"	31 1/4"	28 1/2"	19"	20 1/2"	19 3/4"
OMC339024DDN	18"	30"	31 1/2"	27"	30"	31 1/2"	16 1/4"	31 1/4"	30"	19"	20 1/2"	19 3/4"
OMC309324DDN	21"	27"	28 1/2"	24"	27"	28 1/2"	16 1/4"	31 1/4"	27"	22"	23 1/2"	22 3/4"
OMC31.59324DDN	21"	28 1/2"	30"	25 1/2"	28 1/2"	30"	16 1/4"	31 1/4"	28 1/2"	22"	23 1/2"	22 3/4"
OMC339324DDN	21"	30"	31 1/2"	27"	30"	31 1/2"	16 1/4"	31 1/4"	30"	22"	23 1/2"	22 3/4"
OMC309624DDN	24"	27"	28 1/2"	24"	27"	28 1/2"	16 1/4"	31 1/4"	27"	25"	26 1/2"	25 3/4"
OMC31.59624DDN	24"	28 1/2"	30"	25 1/2"	28 1/2"	30"	16 1/4"	31 1/4"	28 1/2"	25"	26 1/2"	25 3/4"
OMC339624DDN	24"	30"	31 1/2"	27"	30"	31 1/2"	16 1/4"	31 1/4"	30"	25"	26 1/2"	25 3/4"

Modifications

ACS	AUTH	CBO	CCO	CFNT0	CFRMO	CND	EX	FB	FDRW	FPFB	FTK	FTK_V	FULL/MFO	MI	NSCH	RD	RECTKL/R	RT	VTK
•	•	•	•	•	•	•	•	•	•	•	•	•	•	•	•	•	•*	•	•*

*RECTKL/R and VTK not available on 93" and 96" high cabinets.

Construction Upgrades

APU	PEU
•	•

Decorative Door Options

CG
•



- Available
- STD Standard on these cabinets

128

OTHER ROOMS

MODIFICATIONS	
Mod.	Description
ADDTK	Add Toekick
AUTHB	Authentic Ends Both
AUTHL	Authentic End Left
AUTHR	Authentic End Right
CBO	Cabinet Box Only
CCO	Cabinet Case Only
CFNTO	Cabinet Front Only
CFP	Cabinet False Panel
CFRMO	Cabinet Frame Only
CND	Cabinet with No Door, with Drawer
EXL	Extended Stile Left
EXR	Extended Stile Right
FB	Finished Ends
FD	Full Depth Shelf
FDRW	Furniture Board Drawer
FPEB	Furniture Finished Plywood End Panels
FTK	Flush Toekick
FTKAV	Flush Toekick Arch
FTKFV	Flush Toekick Furniture
FULL	Full Overlay
ID	Increased Depth
MFO	Modified Full Overlay
MI	Matching Interior
NSCH	Non SoftTouch Hinge
RD	Reduced Depth
RECTKALL	Island Toekick
RECTKBK	Recessed Toekick Back
RECTKL	Recessed Toekick Left
RECTKR	Recessed Toekick Right
RT	Roll Tray
VTK	Void Toekick

CONSTRUCTION UPGRADES	
Mod.	Description
APU	All-plywood Unfinished
PEU	Plywood Ends Unfinished

	Price Point								
		1	2	3	4	5	6	7	8
Desk Height Door Drawer Base, 29" High, 21" Deep									
DHB12 L or R		348	400	428	447	472	483	511	554
DHB15 L or R		371	428	447	476	492	515	537	580
DHB18 L or R		401	481	488	536	536	556	590	639
DHB21 L or R		449	527	542	586	596	614	649	704
DHB24B		495	571	597	635	653	673	709	767
DHB30B		569	657	687	730	751	774	815	882
DHB36B		654	756	790	840	864	890	937	1014

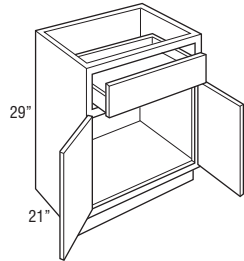
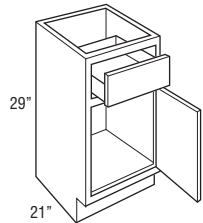

Modifications

ADDTK	AUTH	CBO	CCO	CFNTO	CFP	CFRMO	CND	EX	FB	FD	FDRW	FPEB	FTK	FTK_V	FULL/MFO	ID	MI	NSCH	RD	RECTKALL	RECTKBK	RECTKL/R	RT	VTK
	•	•	•	•	•	•	•	•	•	•	•	•	•	•*				•	•	•	•	•	•	•

*FTKAV/FTKFV not available on DHB12.

Construction Upgrades

APU	PEU
•	•

Price
Point

**Desk Height Drawer Base,
29" High, 21" Deep**

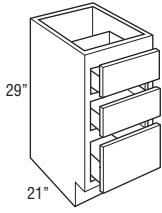

	1	2	3	4	5	6	7	8
3DHBD12	494	508	520	530	535	546	557	587
3DHBD15	535	551	561	572	578	590	602	635
3DHBD18	580	599	611	622	629	642	653	690
3DHBD21	728	748	764	779	788	803	819	863
3DHBD24	908	935	954	972	983	1001	1023	1078

Modifications

ADDTK	AUTH	CBO	CCO	CFNTO	CFP	CFRMO	CND	EX	FB	FD	FDRW	FPEB	FTK	FTK_V	FULL/MFO	ID	IMI	NSCH	RD	RECTKALL	RECTKBK	RECTKL/R	RT	VTK
			•	•	•	•	•	•	•	•	•	•	•	•*		•			•		•	•	•	•

Construction Upgrades

APU	PEU
•	•

*FTKAV/FTKVV not available on 3DHBD12.

**Desk Height File Drawer Base,
29" High, 21" Deep**

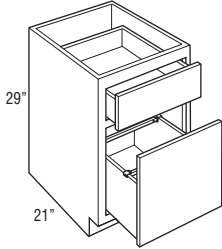

DHFD15	633	651	665	675	682	696	709	748
DHFD18	666	685	700	711	718	733	746	787
DHFD21	699	719	735	747	754	770	783	826

- Door is attached to file drawer.
- File drawer is a solid-wood dovetail drawer that utilizes undermount SoftTouch guide.

Modifications

ADDTK	AUTH	CBO	CCO	CFNTO	CFP	CFRMO	CND	EX	FB	FD	FDRW	FPEB	FTK	FTK_V	FULL/MFO	ID	IMI	NSCH	RD	RECTKALL	RECTKBK	RECTKL/R	RT	VTK
			•	•		•	•	•	•		•	•	•			•					•	•	•	•

Construction Upgrades

APU	PEU
•	•

**Desk Double File Drawer Base,
29" High, 21" Deep**

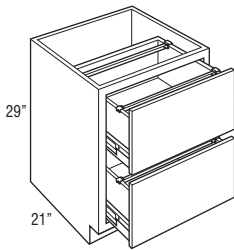

DDFD24	839	863	882	896	905	924	940	991
DDFD30	923	949	970	986	996	1016	1034	1090

- Bottom drawer utilizes 125 lb. full extension progressive side-mount guide, does not feature SoftTouch guide.
- Bottom of drawer is not designed to support any weight.
- Furniture board braces are utilized for drawer guide supports on end panels.

Modifications

ADDTK	AUTH	CBO	CCO	CFNTO	CFP	CFRMO	CND	EX	FB	FD	FDRW	FPEB	FTK	FTK_V	FULL/MFO	ID	IMI	NSCH	RD	RECTKALL	RECTKBK	RECTKL/R	RT	VTK
			•	•		•	•	•	•		•	•	•			•					•	•	•	•

Construction Upgrades

APU	PEU
•	•

Under Counter Drawer, 4 3/4" High, 21" Deep

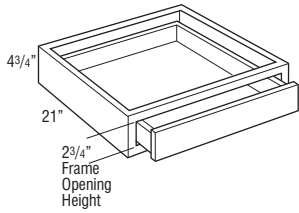

	1	2	3	4	5	6	7	8
UCD2421	332	332	332	332	332	332	332	332
UCD2721	349	349	349	349	349	349	349	349
UCDS3021	376	376	376	376	376	376	376	376
UCDS3621	401	401	401	401	401	401	401	401

- Cabinet is 4 3/4" high. Drawer box within cabinet is 2" high (outside dimension).
- Not trimmable.
- Drawer front is 3/4" slab front.
- Waldron PureStyle™ slab drawer front will be painted hardwood.
- The frame to end panel offset is 3/4", which is designed to accommodate the vanity desk leg.
- Plywood end panels are unfinished. Recommended installation between cabinets, panels, and/or walls.

Modifications

ADDTK	AUTH	CBO	CCO	CFNTO	CFP	CFRMO	CND	EX	FB	FD	FDRW	FPEB	FTK	FTK_V	FULL/MFO	ID	MI	NSCH	RD	RECTKALL	RECTKBK	RECTKL/R	RT	VTK
			•																					

Construction Upgrades

APU	PEU
•	STD

Under Counter Drawer, Trimmable, 4 3/4" High, 21" Deep

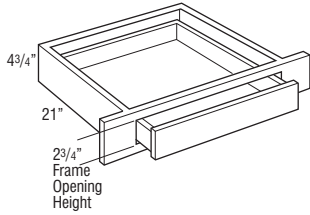

	1	2	3	4	5	6	7	8
UCDT2421	332	332	332	332	332	332	332	332
UCDT3021	376	376	376	376	376	376	376	376
UCDT3621	401	401	401	401	401	401	401	401

- Cabinet is 4 3/4" high. Drawer box within cabinet is 2" high (outside dimension).
- Frame stile is trimmable 3" on each side, which leaves a face frame to end panel offset of 3/4" to accommodate the vanity desk leg.
- Drawer front is 3/4" slab front.
- Waldron PureStyle™ slab drawer front will be painted hardwood.
- Plywood end panels are unfinished. Recommended installation between cabinets, panels, and/or walls.

Modifications

ADDTK	AUTH	CBO	CCO	CFNTO	CFP	CFRMO	CND	EX	FB	FD	FDRW	FPEB	FTK	FTK_V	FULL/MFO	ID	MI	NSCH	RD	RECTKALL	RECTKBK	RECTKL/R	RT	VTK
			•																					

Construction Upgrades

APU	PEU
•	STD

Furniture Drawer, 6 3/4" High, 24" Deep

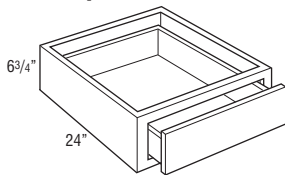

	1	2	3	4	5	6	7	8
FD2406.7524	310	319	325	331	335	342	349	367
FD3006.7524	505	520	529	541	546	558	569	599
FD3606.7524	550	566	578	589	596	606	620	654

- On traditional overlay styles, drawer front to face frame is justified to the top to be consistent with current traditional overlay reveal. Bottom reveal is 1/4".

Modifications

ADDTK	AUTH	CBO	CCO	CFNTO	CFP	CFRMO	CND	EX	FB	FD	FDRW	FPEB	FTK	FTK_V	FULL/MFO	ID	MI	NSCH	RD	RECTKALL	RECTKBK	RECTKL/R	RT	VTK
			•																					

Construction Upgrades

APU	PEU
•	•

Furniture Drawer, 12" High, 24" Deep

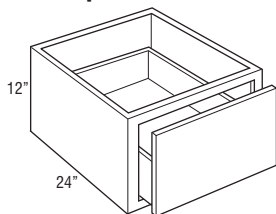

	1	2	3	4	5	6	7	8
FD241224	435	444	450	456	460	467	474	492
FD301224	630	645	654	666	671	683	694	724
FD361224	675	691	703	714	721	731	745	779

- Drawer front to face frame reveal is justified to the bottom to be consistent with both full/modified full overlay and traditional overlay. Top reveal is 1 1/8" for traditional overlay and 3/8" for full/modified full overlay.

Modifications

ADDTK	AUTH	CBO	CCO	CFNTO	CFP	CFRMO	CND	EX	FB	FD	FDRW	FPEB	FTK	FTK_V	FULL/MFO	ID	MI	NSCH	RD	RECTKALL	RECTKBK	RECTKL/R	RT	VTK
			•																					

Construction Upgrades

APU	PEU
•	•

Furniture Drawer Window Bench, 18" High, 24" Deep

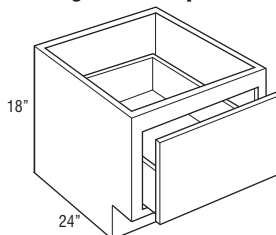

	1	2	3	4	5	6	7	8
FDWB151824	418	430	437	447	451	461	470	497
FDWB181824	464	478	489	498	503	512	523	552
FDWB211824	493	507	518	528	533	543	555	584
FDWB241824	534	549	560	571	577	589	601	633
FDWB271824	702	724	737	753	759	774	790	832
FDWB301824	870	895	913	932	941	961	980	1032
FDWB331824	909	936	955	973	984	1003	1024	1078
FDWB361824	947	975	996	1016	1026	1045	1067	1126

- Drawer front to face frame reveal is justified to the bottom to be consistent with both full overlay and traditional overlay. Traditional overlay top reveal is 2 5/8" and bottom reveal is 1". Full overlay top reveal is 1 7/8" and bottom reveal is 1/4".

Modifications

ADDTK	AUTH	CBO	CCO	CFNTO	CFP	CFRMO	CND	EX	FB	FD	FDRW	FPEB	FTK	FTK_V	FULL/MFO	ID	MI	NSCH	RD	RECTKALL	RECTKBK	RECTKL/R	RT	VTK
			•																					

Construction Upgrades

APU	PEU
•	•

NEW Wall Furniture Bookcase,
48", 51", 54", 57", 60", or
66" High, 12" Deep

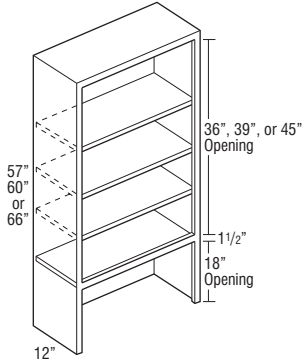
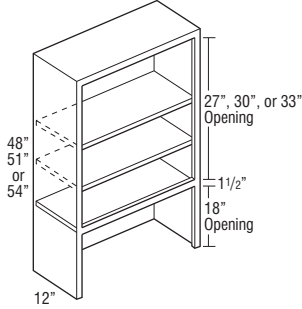

Price Point

	1	2	3	4	5	6	7	8
WFBC1848	1043	1043	1043	1043	1043	1043	1043	1043
WFBC2448	1196	1196	1196	1196	1196	1196	1196	1196
WFBC3048	1450	1450	1450	1450	1450	1450	1450	1450
WFBC3648	1697	1697	1697	1697	1697	1697	1697	1697
WFBC1851	1158	1158	1158	1158	1158	1158	1158	1158
WFBC2451	1329	1329	1329	1329	1329	1329	1329	1329
WFBC3051	1605	1605	1605	1605	1605	1605	1605	1605
WFBC3651	1878	1878	1878	1878	1878	1878	1878	1878
WFBC1854	1158	1158	1158	1158	1158	1158	1158	1158
WFBC2454	1329	1329	1329	1329	1329	1329	1329	1329
WFBC3054	1605	1605	1605	1605	1605	1605	1605	1605
WFBC3654	1878	1878	1878	1878	1878	1878	1878	1878

WFBC1857	1217	1217	1217	1217	1217	1217	1217	1217
WFBC2457	1395	1395	1395	1395	1395	1395	1395	1395
WFBC3057	1682	1682	1682	1682	1682	1682	1682	1682
WFBC3657	1974	1974	1974	1974	1974	1974	1974	1974
WFBC1860	1275	1275	1275	1275	1275	1275	1275	1275
WFBC2460	1460	1460	1460	1460	1460	1460	1460	1460
WFBC3060	1755	1755	1755	1755	1755	1755	1755	1755
WFBC3660	2060	2060	2060	2060	2060	2060	2060	2060
WFBC1866	1389	1389	1389	1389	1389	1389	1389	1389
WFBC2466	1593	1593	1593	1593	1593	1593	1593	1593
WFBC3066	1906	1906	1906	1906	1906	1906	1906	1906
WFBC3666	2241	2241	2241	2241	2241	2241	2241	2241

- 48", 51", and 54" have two adjustable shelves and one fixed shelf.
- 57", 60", and 66" have three adjustable shelves and one fixed shelf.
- Ends, tops, bottoms, and backs are veneer plywood.
- Matching interior.
- Depth can be reduced to a minimum of 9" and increased to a maximum of 15".

Modifications

ADDTK	AUTH	CBO	CCO	CFNTD	CFP	CFRMO	CND	EX	FB	FD	FDRW	FPEB	FTK	FTK_V	FULL/MFO	ID	MI	NSCH	RD	RECTKALL	RECTKBK	RECTKL/R	RT	VTK
	•*	STD															•	STD						

Construction Upgrades

APU	PEU

*AUTHB, AUTHL, and AUTHR not available on 66" high cabinets.

NEW Tall Bookcase,
84", 87", 90", 93", or
96" High, 12" Deep

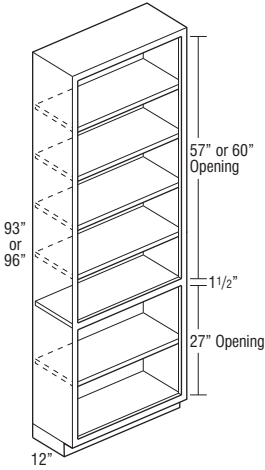
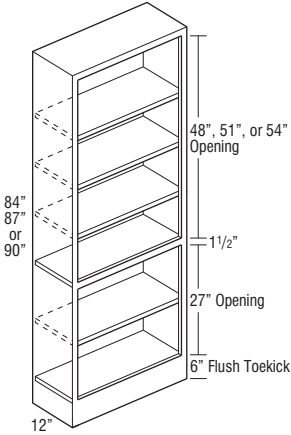

132

OTHER ROOMS

Price Point	1	2	3	4	5	6	7	8
TBC248412	1960	1960	1960	1960	1960	1960	1960	1960
TBC308412	2398	2398	2398	2398	2398	2398	2398	2398
TBC368412	2563	2563	2563	2563	2563	2563	2563	2563
TBC248712	2033	2033	2033	2033	2033	2033	2033	2033
TBC308712	2499	2499	2499	2499	2499	2499	2499	2499
TBC368712	2713	2713	2713	2713	2713	2713	2713	2713
TBC249012	2033	2033	2033	2033	2033	2033	2033	2033
TBC309012	2499	2499	2499	2499	2499	2499	2499	2499
TBC369012	2713	2713	2713	2713	2713	2713	2713	2713
TBC249312	2111	2111	2111	2111	2111	2111	2111	2111
TBC309312	2592	2592	2592	2592	2592	2592	2592	2592
TBC369312	2820	2820	2820	2820	2820	2820	2820	2820
TBC249612	2111	2111	2111	2111	2111	2111	2111	2111
TBC309612	2592	2592	2592	2592	2592	2592	2592	2592
TBC369612	2820	2820	2820	2820	2820	2820	2820	2820

- 84" and 87" tall include four adjustable shelves and one fixed shelf.
- 90" and 93" tall include five adjustable shelves and one fixed shelf.
- 96" tall includes six adjustable shelves and one fixed shelf.
- Ends, tops, bottoms, and backs are veneer plywood.
- Toe kick assembly shipped unattached on 93" and 96", unless FTK options are selected.
- Matching interior.
- Bookcases can only be reduced to 9".

Modifications

ADDTK	AUTH	CBO	CCO	CFNTO	CFP	CFRMO	CND	EX	FB	FD	FDRW	FPFB	FTK	FTK_V	FULL/MFO	ID	MI	NSCH	RD	RECTKALL	RECTKBK	RECTKL/R	RT	VTK

Construction Upgrades

APU	PEU

*FTK is standard on 84", 87", and 90" high cabinets; FTK is available on 93" and 96" high cabinets.

VSB24B

Cabinet Type ← → Cabinet Width

NOTE:
Shelves and roll trays must be ordered separately unless noted.

MODIFICATIONS				CONSTRUCTION UPGRADES		MODIFICATIONS GRID KEY	
Mod.	Description	Mod.	Description	Mod.	Description	•	Available
AUTHB	Authentic Ends Both	FTK	Flush Toekick	APU	All-plywood Unfinished	STD	Standard on these cabinets
AUTHL	Authentic End Left	FTKAV	Flush Toekick Arch	PEU	Plywood Ends Unfinished		
AUTHR	Authentic End Right	FTKRV	Flush Toekick Furniture				
CBO	Cabinet Box Only	FULL	Full Overlay				
CCO	Cabinet Case Only	ID	Increased Depth				
CFNTO	Cabinet Front Only	MFO	Modified Full Overlay				
CFP	Cabinet False Panel	MI	Matching Interior				
CFRMO	Cabinet Frame Only	NSCH	Non SoftTouch Hinge				
EXL	Extended Shile Left	RD	Reduced Depth				
EXR	Extended Shile Right	RECTKBK	Recessed Toekick Back				
FB	Finished Ends	RECTKL	Recessed Toekick Left				
FDRW	Furniture Board Drawer	RECTKR	Recessed Toekick Right				
FPEB	Furniture Finished Plywood End Panels	RT	Roll Tray				
		VTK	Void Toekick				

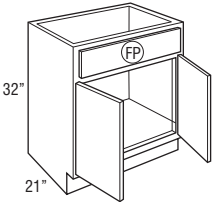
	Price Point	1	2	3	4	5	6	7	8													
Vanity Sink Base with False Panel, 32" High, 21" Deep 	VSB24B	432	499	548	556	606	620	651	706													
	VSB27B	455	522	548	583	639	649	689	744													
	VSB30B	488	568	622	632	682	710	743	804													
	VSB33B	534	627	689	698	761	790	831	899													
	VSB36B	555	645	714	717	787	832	874	945													
Modifications																						
	AUTH	CBO	CCO	CFNTO	CFP	CFRMO	EX	FB	FDRW	FPEB	FTK	FTK_V	FULL/MFO	ID	MI	NSCH	RD	RECTKBK	RECTKL/R	RT	VTK	
	•		•	•	•	•	•	•		•	•	•		•	•	•	•	•	•	•	•	•
Construction Upgrades																						
	APU	PEU																				
	•	•																				

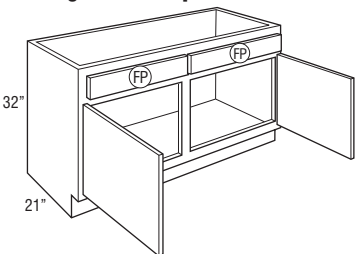
Vanity Sink Base with False Panels, 32" High, 21" Deep 	VSB39	557	647	717	720	790	835	877	947													
	VSB42	575	670	741	744	817	863	906	980													
	VSB45	595	694	768	770	846	895	937	1014													
	VSB48	614	716	793	795	874	925	968	1048													
	VSB54	810	937	1002	1042	1107	1136	1186	1283													
VSB60	895	1039	1112	1156	1226	1257	1314	1421														
Modifications																						
	AUTH	CBO	CCO	CFNTO	CFP	CFRMO	EX	FB	FDRW	FPEB	FTK	FTK_V	FULL/MFO	ID	MI	NSCH	RD	RECTKBK	RECTKL/R	RT	VTK	
	•		•	•	•	•	•	•		•	•	•		•	•	•	•	•	•	•	•	•
Construction Upgrades																						
	APU	PEU																				
	•	•																				

**Vanity Sink Base with False Panel,
34 1/2" High, 21" Deep**

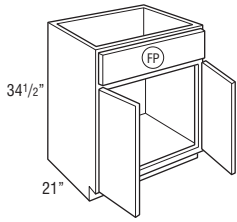

	Price Point	1	2	3	4	5	6	7	8
VS24BBH		481	562	603	625	662	685	717	775
VS27BBH		495	587	647	655	712	737	777	842
VS30BBH		526	631	680	704	755	796	842	908
VS33BBH		542	661	720	733	793	849	896	968
VS36BBH		571	689	764	769	842	901	951	1027

Modifications

AUTH	CBO	CCO	CFNTO	CFP	CFRMO	EX	FB	FDRW	FPEB	FTK	FTK_V	FULL/MFO	ID	MI	NSCH	RD	RECTKBK	RECTKL/R	RT	VTK	
•	•	•	•	•	•	•	•	•	•	•	•	•	•	•	•	•	•	•	•	•	•

Construction Upgrades

APU	PEU
•	•

**Vanity Sink Base with False Panels,
34 1/2" High, 21" Deep**

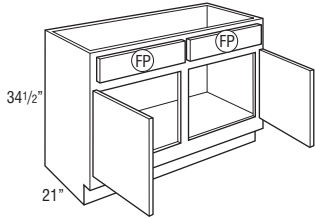

VS39BH		557	647	717	720	790	835	877	947
VS42BH		575	670	741	744	817	863	906	980
VS45BH		595	694	768	770	846	895	937	1014
VS48BH		614	716	793	795	874	925	968	1048

Modifications

AUTH	CBO	CCO	CFNTO	CFP	CFRMO	EX	FB	FDRW	FPEB	FTK	FTK_V	FULL/MFO	ID	MI	NSCH	RD	RECTKBK	RECTKL/R	RT	VTK	
•	•	•	•	•	•	•	•	•	•	•	•	•	•	•	•	•	•	•	•	•	•

Construction Upgrades

APU	PEU
•	•

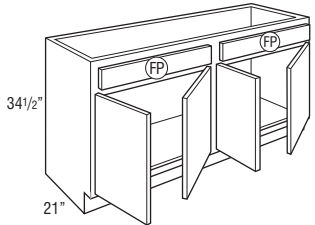

VS54BH		810	937	1002	1042	1107	1136	1186	1283
VS60BH		895	1039	1112	1156	1226	1257	1314	1421

Modifications

AUTH	CBO	CCO	CFNTO	CFP	CFRMO	EX	FB	FDRW	FPEB	FTK	FTK_V	FULL/MFO	ID	MI	NSCH	RD	RECTKBK	RECTKL/R	RT	VTK	
•	•	•	•	•	•	•	•	•	•	•	•*	•	•	•	•	•	•	•	•	•	•

Construction Upgrades

APU	PEU
•	•

**Vanity Base, Single Door with
Drawer, 32" High, 21" Deep**

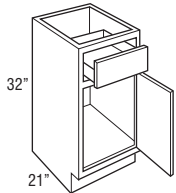

VB12 L or R		338	400	428	447	472	483	511	554
VB15 L or R		371	428	447	476	492	515	537	580
VB18 L or R		401	481	488	536	536	556	590	639
VB21 L or R		450	527	543	586	599	616	651	706

*FTKAV/FTKFV not available on VB12.

**Vanity Base, Double Door with
Drawer, 32" High, 21" Deep**

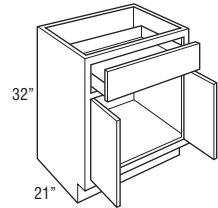

VB24B		495	573	597	639	653	673	709	767
--------------	--	-----	-----	-----	-----	-----	-----	-----	-----

Modifications

AUTH	CBO	CCO	CFNTO	CFP	CFRMO	EX	FB	FDRW	FPEB	FTK	FTK_V	FULL/MFO	ID	MI	NSCH	RD	RECTKBK	RECTKL/R	RT	VTK	
•	•	•	•	•	•	•	•	•	•	•	•	•	•	•	•	•	•	•	•	•	•

Construction Upgrades

APU	PEU
•	•

Vanity Base, Single Door with Drawer, 34 1/2" High, 21" Deep

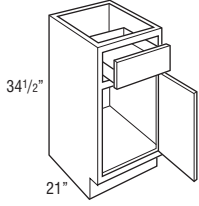

	1	2	3	4	5	6	7	8
VB12BH L or R	380	464	504	515	558	571	602	650
VB15BH L or R	401	488	527	541	577	600	633	683
VB18BH L or R	432	522	559	579	615	644	682	738
VB21BH L or R	470	562	595	625	651	691	734	793

Modifications

AUTH	CBO	CCO	CFNTO	CFP	CFRMO	EX	FB	FDRW	FPEB	FTK	FTK_V	FULL/MFO	ID	MI	NSCH	RD	RECTKBK	RECTKL/R	RT	VTK	
•	•	•	•	•	•	•	•	•	•	•	•*			•	•	•	•	•	•	•	•

Construction Upgrades

APU	PEU
•	•

*FTKAV/FTKFV not available on VB12BH.

Vanity Base, Double Door with Drawer, 34 1/2" High, 21" Deep

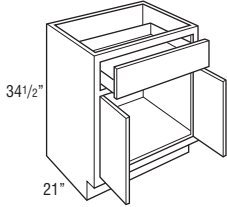

VB24BBH	544	653	698	731	767	818	853	923
----------------	-----	-----	-----	-----	-----	-----	-----	-----

Modifications

AUTH	CBO	CCO	CFNTO	CFP	CFRMO	EX	FB	FDRW	FPEB	FTK	FTK_V	FULL/MFO	ID	MI	NSCH	RD	RECTKBK	RECTKL/R	RT	VTK
•	•	•	•	•	•	•	•	•	•	•	•			•	•	•	•	•	•	•

Construction Upgrades

APU	PEU
•	•

Vanity Three Drawer Base, 32" High, 21" Deep

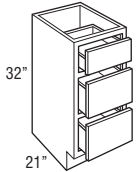

VBD12	494	508	520	530	535	546	557	587
VBD15	535	551	561	572	578	590	602	635
VBD18	580	599	611	622	629	642	653	690
VBD21	626	645	659	672	678	691	706	744
VBD24	669	688	703	717	725	738	754	793

Modifications

AUTH	CBO	CCO	CFNTO	CFP	CFRMO	EX	FB	FDRW	FPEB	FTK	FTK_V	FULL/MFO	ID	MI	NSCH	RD	RECTKBK	RECTKL/R	RT	VTK
•	•	•	•	•	•	•	•	•	•	•	•*			•	•	•	•	•	•	•

Construction Upgrades

APU	PEU
•	•

*FTKAV/FTKFV not available on VBD12.

Vanity Three Drawer Base, 34 1/2" High, 21" Deep

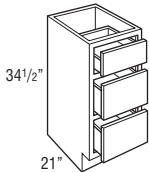

VBD12BH	571	588	600	612	617	630	643	678
VBD15BH	601	618	631	644	649	664	676	712
VBD18BH	636	653	669	680	688	703	717	757
VBD21BH	675	697	709	725	732	746	760	801
VBD24BH	733	755	769	786	793	810	825	873

Modifications

AUTH	CBO	CCO	CFNTO	CFP	CFRMO	EX	FB	FDRW	FPEB	FTK	FTK_V	FULL/MFO	ID	MI	NSCH	RD	RECTKBK	RECTKL/R	RT	VTK
•	•	•	•	•	•	•	•	•	•	•	•*			•	•	•	•	•	•	•

Construction Upgrades

APU	PEU
•	•

*FTKAV/FTKFV not available on VBD12BH.

**Vanity Four Drawer Base,
34 1/2" High, 21" Deep**

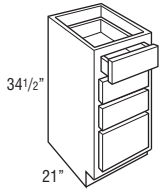

	Price Point	1	2	3	4	5	6	7	8
4VBD12BH		600	617	630	643	648	662	675	711
4VBD15BH		631	649	664	676	682	698	710	749
4VBD18BH		669	688	703	717	725	738	754	793
4VBD21BH		709	732	746	760	767	784	797	843
4VBD24BH		769	792	808	824	832	850	866	914

Modifications

AUTH	CBO	CCO	CFNTD	CFP	CFRMO	EX	FB	FDRW	FPEB	FTK	FTK_V	FULL/MFO	ID	MI	NSCH	RD	RECTKBK	RECTKL/R	RT	VTK
•	•	•	•	•	•	•	•	•	•	•	•*						•	•	•	•

Construction Upgrades

APU	PEU
•	•

*FTKAV/FTKFV not available on 4VBD12BH.

**Vanity Bowl Base, 32" High,
21" Deep**

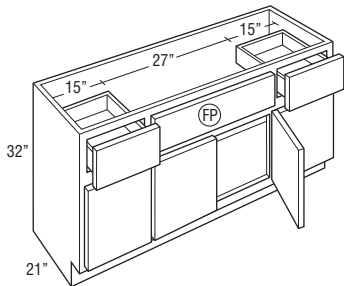
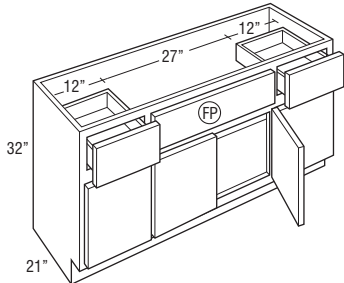
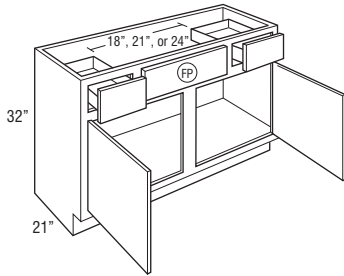
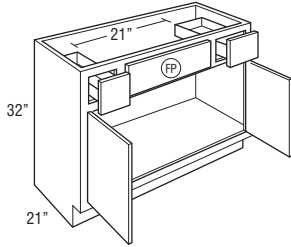

VBB36B	567	659	732	734	804	851	886	961
VBB39	599	701	774	778	854	908	948	1027
VBB42	630	740	819	822	904	964	1010	1092
VBB45	653	770	849	854	937	1001	1053	1137
VBB48	677	799	878	886	969	1038	1092	1181
VBB54	880	1038	1141	1151	1261	1350	1419	1535
VBB60	1065	1256	1381	1393	1526	1633	1717	1857

	Face Frame Opening Width			Available Sink Clearance Width	# of Sink Openings	# of Drawers
	Drawers	Side Doors	False Panel			
VBB36B..	6"	33" (butt doors)	15"	21"	1	2
VBB39..	9"	16 1/2"	12"	18"	1	2
VBB42..	9"	18"	15"	21"	1	2
VBB45..	9"	19 1/2"	18"	24"	1	2
VBB48..	12"	21"	15"	21"	1	2
VBB54..	12"	12"	21"	27"	1	2
VBB60..	15"	15"	21"	27"	1	2

Modifications

AUTH	CBO	CCO	CFNTD	CFP	CFRMO	EX	FB	FDRW	FPEB	FTK	FTK_V	FULL/MFO	ID	MI	NSCH	RD	RECTKBK	RECTKL/R	RT	VTK
•	•	•	•	•	•	•	•	•	•	•	•						•	•	•	•

Construction Upgrades

APU	PEU
•	•

Vanity Bowl Base, 34 1/2" High, 21" Deep

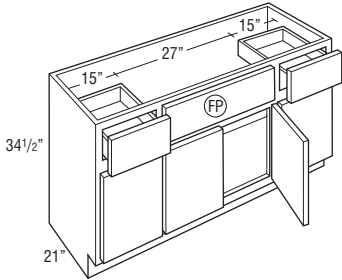
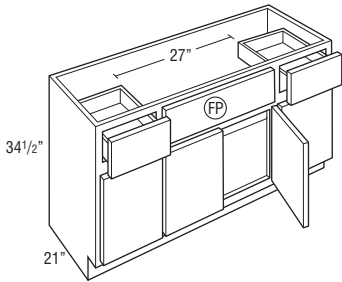
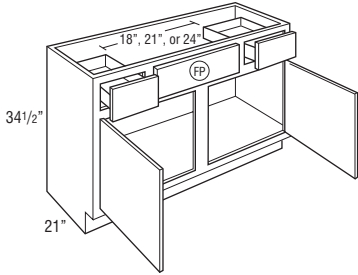
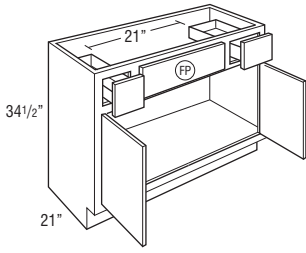

Price Point	1	2	3	4	5	6	7	8
VBB36BBH	633	741	779	824	921	970	1019	1101
VBB39BH	655	770	810	855	960	1018	1069	1156
VBB42BH	677	799	840	886	996	1063	1119	1210
VBB45BH	700	824	866	914	1030	1102	1160	1254
VBB48BH	720	850	892	941	1063	1140	1200	1299
VBB54BH	936	1105	1160	1222	1382	1482	1560	1689
VBB60BH	1133	1337	1404	1480	1672	1793	1888	2044

	Face Frame Opening Width			Available Sink Clearance Width	# of Sink Openings	# of Drawers
	Drawers	Side Doors	False Panel			
VBB36B..	6"	33" (butt doors)	15"	21"	1	2
VBB39..	9"	16 1/2"	12"	18"	1	2
VBB42..	9"	18"	15"	21"	1	2
VBB45..	9"	19 1/2"	18"	24"	1	2
VBB48..	12"	21"	15"	21"	1	2
VBB54..	12"	12"	21"	27"	1	2
VBB60..	15"	15"	21"	27"	1	2

Modifications

AUTH	CBO	CCO	CFNTD	CFP	CFRMO	EX	FB	FDRW	FPEB	FTK	FTK_V	FULL/MFO	ID	MI	NSCH	RD	RECTKBK	RECTKL/R	RT	VTK	
•	•	•	•	•	•	•	•	•	•	•	•	•	•	•	•	•	•	•	•	•	•

Construction Upgrades

APU	PEU
•	•

Vanity Bowl Base with False Panel, 32" High, 21" Deep

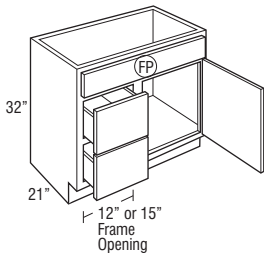

VB30D L or R	643	744	787	827	863	909	957	1034
VB36D L or R	739	852	876	946	966	1003	1051	1134

• L or R indicates drawer location.

	Face Frame Opening Width		Available Sink Clearance Width	# of Sink Openings	# of Drawers
	Drawers	Side Doors			
VB30D..	12"	12"	27"	1	2
VB36D..	15"	15"	33"	1	2

Modifications

AUTH	CBO	CCO	CFNTD	CFP	CFRMO	EX	FB	FDRW	FPEB	FTK	FTK_V	FULL/MFO	ID	MI	NSCH	RD	RECTKBK	RECTKL/R	RT	VTK	
•	•	•	•	•	STD	•	•	•	•	•	•	•	•	•	•	•	•	•	•	•	•

Construction Upgrades

APU	PEU
•	•

Vanity Bowl Base with False Panel, 32" High, 21" Deep

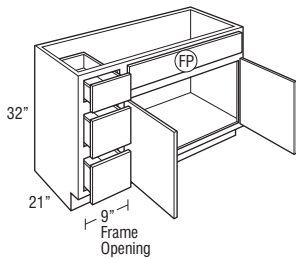
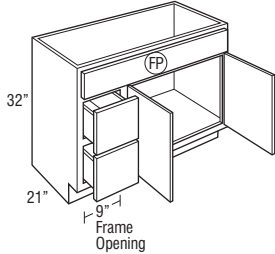
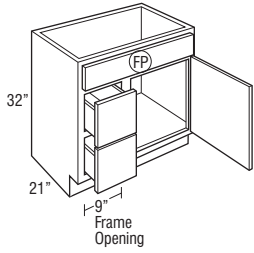

Price Point	1	2	3	4	5	6	7	8
VBB24D L or R	586	709	750	792	824	864	911	985
VBB27D L or R	614	728	769	811	845	887	934	1010
VBB30D L or R	643	744	787	827	863	909	957	1034
VBB33D L or R	691	799	831	887	915	956	1004	1085

VBB36D L or R	739	852	876	946	966	1003	1051	1134
----------------------	-----	-----	-----	-----	-----	------	------	------

VBB39D L or R	835	978	1010	1087	1114	1166	1225	1324
----------------------	-----	-----	------	------	------	------	------	------

VBB423D L or R	893	1046	1081	1163	1192	1248	1311	1417
-----------------------	-----	------	------	------	------	------	------	------

VBB483D L or R	956	1119	1157	1244	1275	1335	1403	1516
-----------------------	-----	------	------	------	------	------	------	------

• L or R indicates drawer location.

	Face Frame Opening Width		Available Sink Clearance Width	# of Sink Openings	# of Drawers
	Drawers	Doors			
VBB24D..	9"	9"	21"	1	2
VBB27D..	9"	12"	24"	1	2
VBB30D..	9"	15"	27"	1	2
VBB33D..	9"	18"	30"	1	2
VBB36D..	9"	21"	33"	1	2
VBB39D..	9"	24"	27"	1	3
VBB423D..	9"	27"	30"	1	3
VBB483D..	9"	33"	36"	1	3

Modifications

AUTH	CBO	CCO	CFNTD	CFP	CFRMO	EX	FB	FDRW	FPEB	FTK	FTK_V	FULL/MFO	ID	MI	NSCH	RD	RECTKBK	RECTKL/R	RT	VTK	
•	•	•	•	•	•	•	•	•	•	•	•	•	•	•	•	•	•	•	•	•	•

*CFP is standard on 24"-36" wide cabinets; CFP is available on 39"-48" wide cabinets.

Construction Upgrades

APU	PEU
•	•

Vanity Bowl Base with False Panel, 32" High, 21" Deep

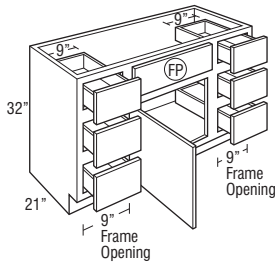

VBB42D L or R	932	1103	1145	1226	1262	1327	1397	1512
----------------------	-----	------	------	------	------	------	------	------

VBB45D L or R	988	1174	1215	1305	1339	1410	1483	1604
----------------------	-----	------	------	------	------	------	------	------

• Specify L or R door swing.

	Face Frame Opening Width		Available Sink Clearance Width	# of Sink Openings	# of Drawers
	Drawers	Doors			
VBB42D..	9"	15"	21"	1	6
VBB45D..	9"	18"	24"	1	6

Modifications

AUTH	CBO	CCO	CFNTD	CFP	CFRMO	EX	FB	FDRW	FPEB	FTK	FTK_V	FULL/MFO	ID	MI	NSCH	RD	RECTKBK	RECTKL/R	RT	VTK	
•	•	•	•	•	•	•	•	•	•	•	•	•	•	•	•	•	•	•	•	•	•

Construction Upgrades

APU	PEU
•	•

Vanity Bowl Base with Six Drawers & False Panel, 32" High, 21" Deep

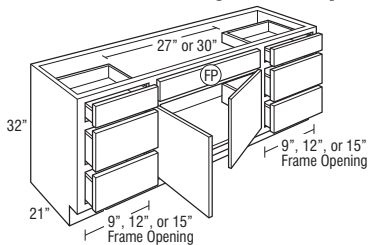

VBB48D	1042	1243	1285	1383	1417	1492	1568	1697
---------------	------	------	------	------	------	------	------	------

VBB54D	1079	1281	1326	1425	1462	1542	1623	1755
---------------	------	------	------	------	------	------	------	------

VBB57D	1137	1349	1395	1500	1538	1624	1709	1849
---------------	------	------	------	------	------	------	------	------

VBB60D	1168	1386	1434	1541	1581	1670	1755	1897
---------------	------	------	------	------	------	------	------	------

	Face Frame Opening Width		Available Sink Clearance Width	# of Sink Openings	# of Drawers
	Drawers	Doors			
VBB48D..	9"	21"	27"	1	6
VBB54D..	12"	21"	27"	1	6
VBB57D..	12"	24"	30"	1	6
VBB60D..	15"	21"	27"	1	6

Modifications

AUTH	CBO	CCO	CFNTD	CFP	CFRMO	EX	FB	FDRW	FPEB	FTK	FTK_V	FULL/MFO	ID	MI	NSCH	RD	RECTKBK	RECTKL/R	RT	VTK	
•	•	•	•	•	•	•	•	•	•	•	•	•	•	•	•	•	•	•	•	•	•

Construction Upgrades

APU	PEU
•	•

Vanity Bowl Base with False Panel, 34 1/2" High, 21" Deep

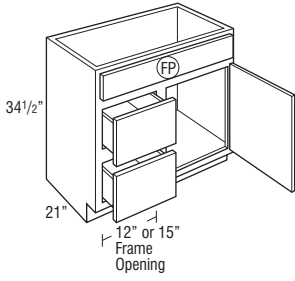

	1	2	3	4	5	6	7	8
VB30DLBH/DRBH	697	818	862	911	951	1019	1079	1168
VB36DLBH/DRBH	823	951	1002	1060	1104	1143	1211	1309

• L or R indicates drawer location.

	Face Frame Opening Width		Available Sink Clearance Width	# of Sink Openings	# of Drawers
	Drawers	Side Doors			
VB30D..	12"	12"	27"	1	2
VB36D..	15"	15"	33"	1	2

Modifications

AUTH	CBO	CCO	CFNTD	CFP	CFRMO	EX	FB	FDRW	FPEB	FTK	FTK_V	FULL/MFO	ID	MI	NSCH	RD	RECTKBK	RECTKL/R	RT	VTK
•	•	•	•	STD	•	•	•	•	•	•	•	•	•	•	•	•	•	•	•	•

Construction Upgrades

APU	PEU
•	•

Vanity Bowl Base with False Panel, 34 1/2" High, 21" Deep

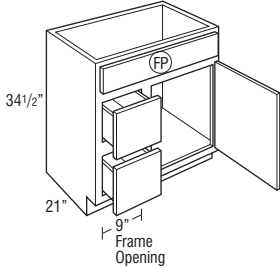

VBB24DLBH/DRBH	653	766	823	854	910	946	1004	1087
VBB27DLBH/DRBH	675	792	844	883	931	983	1042	1128
VBB30DLBH/DRBH	697	818	862	911	951	1019	1079	1168
VBB33DLBH/DRBH	760	885	932	986	1028	1081	1145	1239

VBB36DLBH/DRBH	823	951	1002	1060	1104	1143	1211	1309
-----------------------	-----	-----	------	------	------	------	------	------

VBB39DLBH/DRBH	904	1057	1129	1176	1245	1298	1369	1482
VBB423DLBH/DRBH	967	1131	1208	1258	1332	1389	1465	1586
VBB483DLBH/DRBH	1035	1210	1293	1346	1425	1486	1568	1697

• L or R indicates drawer location.

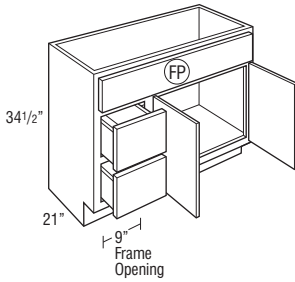

	Face Frame Opening Width		Available Sink Clearance Width	# of Sink Openings	# of Drawers
	Drawers	Doors			
VBB24D..	9"	9"	21"	1	2
VBB27D..	9"	12"	24"	1	2
VBB30D..	9"	15"	27"	1	2
VBB33D..	9"	18"	30"	1	2
VBB36D..	9"	21"	33"	1	2
VBB39D..	9"	24"	27"	1	3
VBB423D..	9"	27"	30"	1	3
VBB483D..	9"	33"	36"	1	3

Modifications

AUTH	CBO	CCO	CFNTD	CFP	CFRMO	EX	FB	FDRW	FPEB	FTK	FTK_V	FULL/MFO	ID	MI	NSCH	RD	RECTKBK	RECTKL/R	RT	VTK
•	•	•	•	STD*	•	•	•	•	•	•	•	•	•	•	•	•	•	•	•	•

Construction Upgrades

APU	PEU
•	•

*CFP is standard on 24"-36" wide cabinets; CFP is available on 39"-48" wide cabinets.

Vanity Bowl Base with False Panel, 34 1/2" High, 21" Deep

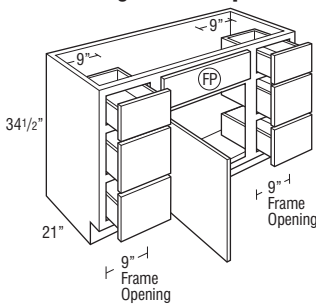

VBB42DBH L or R	984	1161	1255	1291	1386	1451	1528	1653
VBB45DBH L or R	1048	1234	1333	1372	1469	1541	1623	1757

• Specify L or R door swing.

	Face Frame Opening Width		Available Sink Clearance Width	# of Sink Openings	# of Drawers
	Drawers	Doors			
VBB42D..	9"	15"	21"	1	6
VBB45D..	9"	18"	24"	1	6

Modifications

AUTH	CBO	CCO	CFNTD	CFP	CFRMO	EX	FB	FDRW	FPEB	FTK	FTK_V	FULL/MFO	ID	MI	NSCH	RD	RECTKBK	RECTKL/R	RT	VTK
•	•	•	•	•	•	•	•	•	•	•	•	•	•	•	•	•	•	•	•	•

Construction Upgrades

APU	PEU
•	•

Vanity Bowl Base with Six Drawers & False Panel, 34 1/2" High, 21" Deep

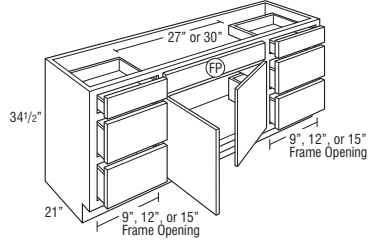

Price Point	1	2	3	4	5	6	7	8
VBB48DBH	1111	1305	1410	1452	1553	1631	1717	1857
VBB54DBH	1185	1421	1538	1583	1697	1800	1891	2045
VBB57DBH	1247	1495	1618	1665	1786	1894	1988	2153
VBB60DBH	1281	1535	1663	1711	1834	1946	2045	2212

	Face Frame Opening Width		Available Sink Clearance Width	# of Sink Openings	# of Drawers
	Drawers	Doors			
VBB48D..	9"	21"	27"	1	6
VBB54D..	12"	21"	27"	1	6
VBB57D..	12"	24"	30"	1	6
VBB60D..	15"	21"	27"	1	6

Modifications

AUTH	CBO	CCO	CFNTD	CFP	CFRMO	EX	FB	FDRW	FPEB	FTK	FTK_V	FULL/MFO	ID	MI	NSCH	RD	RECTKBK	RECTKL/R	RT	VTK	
•	•	•	•	•	•	•	•	•	•	•	•	•	•	•	•	•	•	•	•	•	•

Construction Upgrades

APU	PEU
•	•

Vanity Drawer Base with False Panels, 32" High, 21" Deep

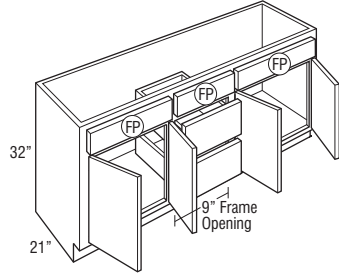

VDB60FP3	988	1151	1180	1295	1308	1354	1431	1556
-----------------	-----	------	------	------	------	------	------	------

	Face Frame Opening Width		Available Sink Clearance Width	# of Sink Openings	# of Drawers
	Drawers	Doors			
VDB60..	9"	21"	24"	2	2

Modifications

AUTH	CBO	CCO	CFNTD	CFP	CFRMO	EX	FB	FDRW	FPEB	FTK	FTK_V	FULL/MFO	ID	MI	NSCH	RD	RECTKBK	RECTKL/R	RT	VTK	
•	•	•	•	STD	•	•	•	•	•	•	•	•	•	•	•	•	•	•	•	•	•

Construction Upgrades

APU	PEU
•	•

Vanity Drawer Base with False Panels, 34 1/2" High, 21" Deep

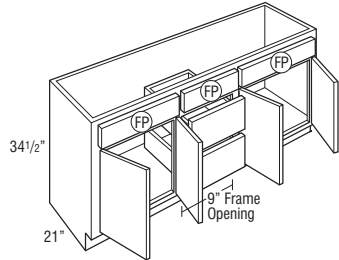

VDB60FP3BH	1049	1249	1359	1402	1505	1586	1673	1816
-------------------	------	------	------	------	------	------	------	------

	Face Frame Opening Width		Available Sink Clearance Width	# of Sink Openings	# of Drawers
	Drawers	Doors			
VDB60..	9"	21"	24"	2	2

Modifications

AUTH	CBO	CCO	CFNTD	CFP	CFRMO	EX	FB	FDRW	FPEB	FTK	FTK_V	FULL/MFO	ID	MI	NSCH	RD	RECTKBK	RECTKL/R	RT	VTK	
•	•	•	•	STD	•	•	•	•	•	•	•	•	•	•	•	•	•	•	•	•	•

Construction Upgrades

APU	PEU
•	•

**Vanity Drawer Base, 32" High,
21" Deep**

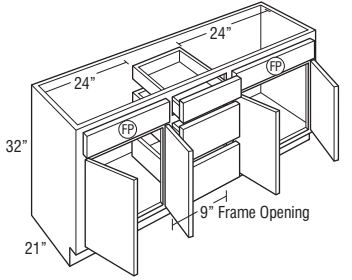
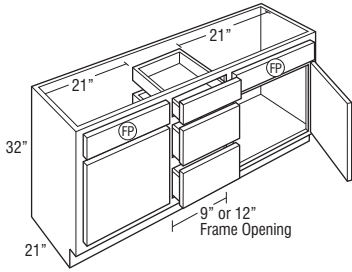

Price Point	1	2	3	4	5	6	7	8
VDB54	1028	1184	1211	1320	1333	1375	1449	1565
VDB57	1055	1216	1243	1355	1367	1412	1486	1608

VDB60	1083	1246	1275	1390	1403	1449	1526	1651
--------------	------	------	------	------	------	------	------	------

	Face Frame Opening Width		Available Sink Clearance Width	# of Sink Openings	# of Drawers
	Drawers	Doors			
VDB54..	9"	18"	21"	2	3
VDB57..	12"	18"	21"	2	3
VDB60..	9"	21"	24"	2	3

Modifications

AUTH	CBO	CCO	CFNTD	CFP	CFRMO	EX	FB	FDRW	FPEB	FTK	FTK_V	FULL/MFO	ID	MI	NSCH	RD	RECTKBK	RECTKL/R	RT	VTK	
•	•	•	•	•	•	•	•	•	•	•	•	•	•	•	•	•	•	•	•	•	•

Construction Upgrades

APU	PEU
•	•

**Vanity Drawer Base, 34 1/2" High,
21" Deep**

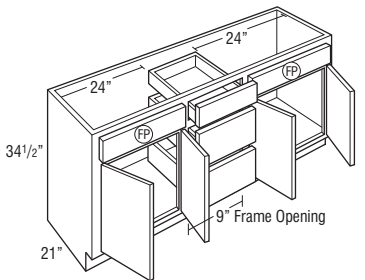
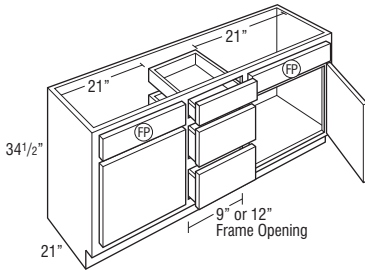

VDB54BH	1087	1277	1380	1422	1521	1598	1680	1817
VDB57BH	1115	1311	1417	1460	1562	1640	1724	1864

VDB60BH	1144	1344	1454	1497	1600	1681	1768	1911
----------------	------	------	------	------	------	------	------	------

	Face Frame Opening Width		Available Sink Clearance Width	# of Sink Openings	# of Drawers
	Drawers	Doors			
VDB54..	9"	18"	21"	2	3
VDB57..	12"	18"	21"	2	3
VDB60..	9"	21"	24"	2	3

Modifications

AUTH	CBO	CCO	CFNTD	CFP	CFRMO	EX	FB	FDRW	FPEB	FTK	FTK_V	FULL/MFO	ID	MI	NSCH	RD	RECTKBK	RECTKL/R	RT	VTK	
•	•	•	•	•	•	•	•	•	•	•	•	•	•	•	•	•	•	•	•	•	•

Construction Upgrades

APU	PEU
•	•

Linen Utility with Hamper, 84" Tall, 21" Deep

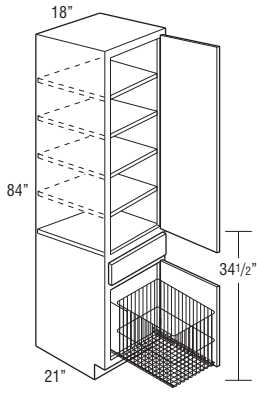

LT188421BH L or R	1323	1464	1487	1628	1634	1657	1818	1918
--------------------------	------	------	------	------	------	------	------	------

- Designed to be used with 34 1/2" high vanities.
- Hamper size is 14 3/4" wide x 19 3/8" high x 18" deep.
- Tall mitered door styles and PureStyle™ door styles will feature one center panel, other door styles will feature two center panels.

Modifications

AUTH	CBO	CCO	CFNTD	CFP	CFRMO	EX	FB	FDRW	FPEB	FTK	FTK_V	FULL/MFO	ID	MI	NSCH	RD	RECTKBK	RECTKL/R	RT	VTK	
•	•	•	•	•	•	•	•	•	•	•	•	•	•	•	•	•	•	•	•	•	•

Construction Upgrades

APU	PEU
•	•

142

VANITY CABINETS

Linen Storage Cabinet

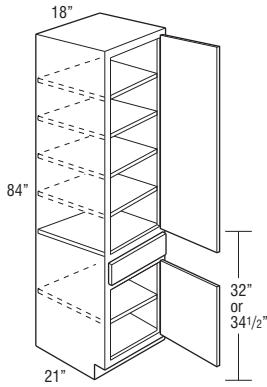

LT188421 L or R	1323	1464	1487	1628	1634	1657	1818	1918
------------------------	------	------	------	------	------	------	------	------

LT188421BH L or R	1323	1464	1487	1628	1634	1657	1818	1918
--------------------------	------	------	------	------	------	------	------	------

- LT188421 designed to be used with 32" high vanities.
- LT188421BH designed to be used with 34 1/2" high vanities.
- Tall mitered door styles and PureStyle™ door styles will feature one center panel, other door styles will feature two center panels.

Modifications

AUTH	CBO	CCO	CFNTD	CFP	CFRMO	EX	FB	FDRW	FPEB	FTK	FTK_V	FULL/MFO	ID	MI	NSCH	RD	RECTKBK	RECTKL/R	RT	VTK	
•	•	•	•	•	•	•	•	•	•	•	•	•	•	•	•	•	•	•	•	•	•

Construction Upgrades

APU	PEU
•	•

Vanity Wall, 30" High, 6" Deep

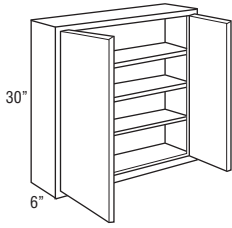

W24306B	405	497	522	554	601	611	645	688
----------------	-----	-----	-----	-----	-----	-----	-----	-----

Modifications

AUTH	CBO	CCO	CFNTD	CFP	CFRMO	EX	FB	FDRW	FPEB	FTK	FTK_V	FULL/MFO	ID	MI	NSCH	RD	RECTKBK	RECTKL/R	RT	VTK	
		•	•	•	•	•	•	•	•	•	•	•	•	•	•	•	•	•	•	•	•

Decorative Door Options

CG	MD
•	•

Construction Upgrades

APU	PEU
•	•

Wall Boutique

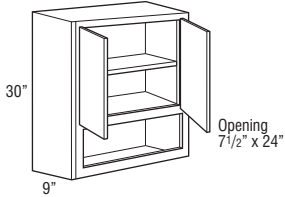

WB2730B	503	611	642	681	749	761	819	863
----------------	-----	-----	-----	-----	-----	-----	-----	-----

- Includes 1 adjustable shelf.
- Cabinet has butt doors, no center stile.
- Cabinet opening matches cabinet exterior.

Modifications

AUTH	CBO	CCO	CFNTD	CFP	CFRMO	EX	FB	FDRW	FPEB	FTK	FTK_V	FULL/MFO	ID	MI	NSCH	RD	RECTKBK	RECTKL/R	RT	VTK	
		•	•	•	•	•			•			•		STD	•						

Construction Upgrades

APU	PEU

Single Door Medicine Cabinet

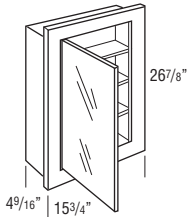

MC16	490	490	490	490	490	490	490	490
-------------	-----	-----	-----	-----	-----	-----	-----	-----

- Cut-out dimensions are 14 7/16" wide x 25 5/8" high x 4" deep.
- Unit can be surface mounted or recessed.
- Door of cabinet is glass mirror, 12 5/8" wide x 23 1/2" high.
- Matching cabinet doors not available.
- Cabinet has wood frame.
- 1/2" plywood ends, tops, and bottoms.
- Natural Maple laminate interior.
- 3/4" laminated plywood shelves.

Modifications

AUTH	CBO	CCO	CFNTD	CFP	CFRMO	EX	FB	FDRW	FPEB	FTK	FTK_V	FULL/MFO	ID	MI	NSCH	RD	RECTKBK	RECTKL/R	RT	VTK	
		•	•				STD								•						

Construction Upgrades

APU	PEU
STD	

Under Counter Drawer, 4 3/4" High, 21" Deep

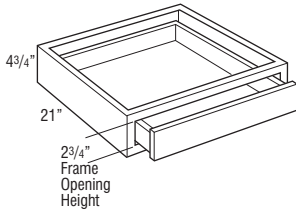

UCD2421	332	332	332	332	332	332	332	332
UCD2721	349	349	349	349	349	349	349	349
UCDS3021	376	376	376	376	376	376	376	376
UCDS3621	401	401	401	401	401	401	401	401

- Cabinet is 4 3/4" high. Drawer box within cabinet is 2" high (outside dimension).
- Not trimmable.
- Drawer front is 3/4" slab front.
- Waldron PureStyle™ slab drawer front will be painted hardwood.
- The frame to end panel offset is 3/4", which is designed to accommodate the vanity desk leg.
- Plywood end panels are unfinished. Recommended installation between cabinets, panels, and/or walls.

Modifications

AUTH	CBO	CCO	CFNTD	CFP	CFRMO	EX	FB	FDRW	FPEB	FTK	FTK_V	FULL/MFO	ID	MI	NSCH	RD	RECTKBK	RECTKL/R	RT	VTK	
		•	•			•	•							•		•					

Construction Upgrades

APU	PEU
•	STD

Under Counter Drawer, Trimmable, 4 3/4" High, 21" Deep

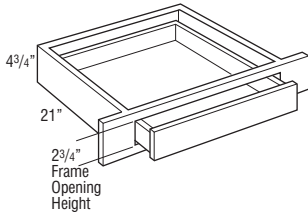

UCDT2421	332	332	332	332	332	332	332	332
UCDT3021	376	376	376	376	376	376	376	376
UCDT3621	401	401	401	401	401	401	401	401

- Cabinet is 4 3/4" high. Drawer box within cabinet is 2" high (outside dimension).
- Frame stile is trimmable 3" on each side, which leaves a face frame to end panel offset of 3/4" to accommodate the vanity desk leg.
- Drawer front is 3/4" slab front.
- Waldron PureStyle™ slab drawer front will be painted hardwood.
- Plywood end panels are unfinished. Recommended installation between cabinets, panels, and/or walls.

Modifications

AUTH	CBO	CCO	CFNTD	CFP	CFRMO	EX	FB	FDRW	FPEB	FTK	FTK_V	FULL/MFO	ID	MI	NSCH	RD	RECTKBK	RECTKL/R	RT	VTK	
		•	•			•								•		•					

Construction Upgrades

APU	PEU
•	STD

**Vanity Wall Mirror Cabinet,
30" High, 4 9/16" Deep**

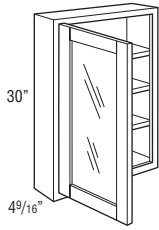

VWM2430 L or R	544	660	694	736	809	822	885	933
-----------------------	-----	-----	-----	-----	-----	-----	-----	-----

- Standard with CG doors and installed mirror glass.
- Unit intended to be surface mounted. Features standard 1/4" face frame reveal on ends.
- Adjustable shelves.
- Not available in Chalet.

Modifications

AUTH	CBO	CCO	CFNT0	CFP	CFRMO	EX	FB	FDRW	FPEB	FTK	FTK_V	FULL/MFO	ID	MI	NSCH	RD	RECTKBK	RECTKL/R	RT	VTK	
•	•	•			•	•	•		•			•		•	•						

Construction Upgrades

APU	PEU
•	•

Vanity Mirror

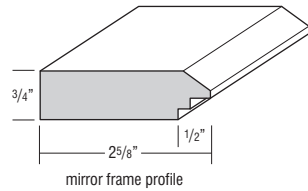
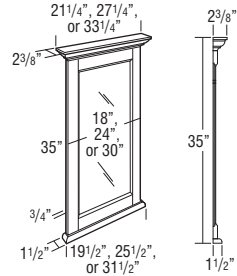

VM2135	N/A	732	732	N/A	N/A	732	732	732
VM2735	N/A	797	797	N/A	N/A	797	797	797
VM3335	N/A	866	866	N/A	N/A	866	866	866

- Moulding included on vanity mirrors is not a standard moulding.
- Mirror glass is beveled.
- Includes two installed metal hanging hooks on back.

Model	Overall Dimensions		Mirror - Visible Dimensions	
	Width	Height	Width	Height
VM2135	21 1/4"	35"	12 15/16"	26 15/16"
VM2735	27 1/4"	35"	18 15/16"	26 15/16"
VM3335	33 1/4"	35"	24 15/16"	26 15/16"

MODIFICATIONS

No modifications available for these products.

Species Availability

Hickory	Maple	Oak	Painted	Rustic Hickory	Laminate
	•		•		Painted

Medicine Cabinet

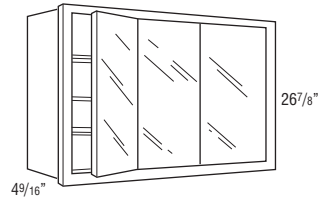

TV30	804	804	804	804	804	804	804	804
TV36	863	863	863	863	863	863	863	863

- Surface or recessed mount.
- When ordering Rustic Hickory, Hickory will be substituted.

Model	Cabinet Dimensions			Cut-out Dimensions		
	Width	Height	Depth	Width	Height	Depth
TV30	30"	26 7/8"	4 9/16"	28 11/16"	25 5/8"	4"
TV36	36"	26 7/8"	4 9/16"	34 11/16"	25 5/8"	4"

Modifications

AUTH	CBO	CCO	CFNT0	CFP	CFRMO	EX	FB	FDRW	FPEB	FTK	FTK_V	FULL/MFO	ID	MI	NSCH	RD	RECTKBK	RECTKL/R	RT	VTK	
•	•			•		STD								•							

Construction Upgrades

APU	PEU
STD	

3" Wide Fillers

UF3	60
F333	64
F336	64
F339	69
F342	75
F348 <small>NEW</small>	84
F351 <small>NEW</small>	90
F354 <small>NEW</small>	96
F357 <small>NEW</small>	102
F360 <small>NEW</small>	108
F384	134
F387	134
F390	144
F393	144
F396	153
F396FH	153
F3108FH [†]	207

- 3/4" thick.
- Finished on front and all edges (backs are unfinished).
- [†]F3108FH only available in Maple and Painted Hardwood.

Species Availability

Hickory	Maple	Oak	Painted	Rustic Hickory	Laminate
•	•	•	•	Hickory	Painted

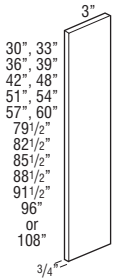

6" Wide Fillers

UF6	110
F633	118
F636	118
F639	127
F642	139
F684	232
F687	232
F690	247
F693	247
F696	263
F696FH	263
F6108FH [†]	355

- 3/4" thick.
- Finished on front and all edges (backs are unfinished).
- [†]F6108FH only available in Maple and Painted Hardwood.

Species Availability

Hickory	Maple	Oak	Painted	Rustic Hickory	Laminate
•	•	•	•	Hickory	Painted

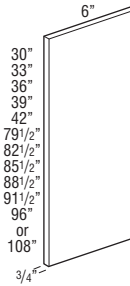

3" Wide Corner Filler

CWF330	109
--------	-----

- 3/4" thick.
- Finished on front and all edges (backs are unfinished).

Species Availability

Hickory	Maple	Oak	Painted	Rustic Hickory	Laminate
•	•	•	•	Hickory	Painted

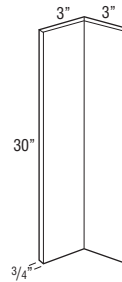

Overlay Filler, 2 1/2" Wide

OL312	60
OL315	60
OL318	60
OL321	60
OL324	60
OL327	60
OL330	60
OL333	64
OL336	64
OL339	69
OL342	75
OL384	134
OL387	144
OL390	144
OL393	153
OL396	153

- 3/4" thick.
- Finished on front and all edges (backs are unfinished).
- Waldron PureStyle™ overlays will be painted hardwood.
- See OL__MFO for use with Modified Full Overlay modification.

Species Availability

Hickory	Maple	Oak	Painted	Rustic Hickory	Laminate
•	•	•	•	•	•

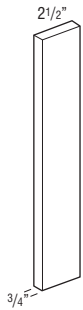

Model	Traditional Overlay Height	Full Overlay Height
OL312	—	11 1/2"
OL315	—	14 1/2"
OL318	—	17 1/2"
OL321	—	20 1/2"
OL324	—	23 1/2"
OL327	—	26 1/2"
OL330	28"	29 1/2"
OL333	31"	32 1/2"
OL336	34"	35 1/2"
OL339	37"	38 1/2"
OL342	40"	41 1/2"
OL384	77 1/2"	79"
OL387	80 1/2"	82"
OL390	83 1/2"	85"
OL393	86 1/2"	88"
OL396	89 1/2"	91"

Overlay Filler for Modified Full Overlay, 2 1/2" Wide

OL312MFO	60
OL315MFO	60
OL318MFO	60
OL321MFO	60
OL324MFO	60
OL327MFO	60
OL330MFO	60
OL333MFO	64
OL336MFO	64
OL339MFO	69
OL342MFO	75
OL384MFO	134
OL387MFO	144
OL390MFO	144
OL393MFO	153
OL396MFO	153

- Available in full overlay door styles. Height will align with wall and tall doors specified with Modified Full Overlay modification. See page 31 for MFO details.

- 3/4" thick.
- Finished on front and all edges (backs are unfinished).
- Waldron PureStyle™ overlays will be painted hardwood.

Species Availability

Hickory	Maple	Oak	Painted	Rustic Hickory	Laminate
•	•	•	•	•	•

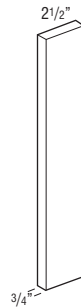

Model	Modified Full Overlay Height
OL312MFO	10 3/4"
OL315MFO	13 3/4"
OL318MFO	16 3/4"
OL321MFO	19 3/4"
OL324MFO	22 3/4"
OL327MFO	25 3/4"
OL330MFO	28 3/4"
OL333MFO	31 3/4"
OL336MFO	34 3/4"
OL339MFO	37 3/4"
OL342MFO	40 3/4"
OL384MFO	78 1/4"
OL387MFO	81 1/4"
OL390MFO	84 1/4"
OL393MFO	87 1/4"
OL396MFO	90 1/4"

Overlay Filler, 5 1/2" Wide

OL630	110
OL633	118
OL636	118
OL639	127
OL642	139
OL684	232
OL687	247
OL690	247
OL693	263
OL696	263

- 3/4" thick.
- Finished on front and all edges (backs are unfinished).
- Waldron PureStyle™ overlays will be painted hardwood.
- See OL__MFO for use with Modified Full Overlay modification.

Species Availability

Hickory	Maple	Oak	Painted	Rustic Hickory	Laminate
•	•	•	•	•	•

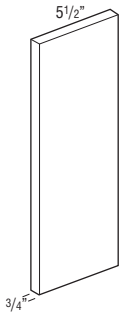

Model	Traditional Overlay Height	Full Overlay Height
OL630	28"	29 1/2"
OL633	31"	32 1/2"
OL636	34"	35 1/2"
OL639	37"	38 1/2"
OL642	40"	41 1/2"
OL684	—	79"
OL687	—	82"
OL690	—	85"
OL693	—	88"
OL696	—	91"

Overlay Filler for Modified Full Overlay, 5 1/2" Wide

OL630MFO	110
OL633MFO	118
OL636MFO	118
OL639MFO	127
OL642MFO	139
OL684MFO	232
OL687MFO	247
OL690MFO	247
OL693MFO	263
OL696MFO	263

- Available in full overlay door styles. Height will align with wall and tall doors specified with Modified Full Overlay modification. See page 31 for MFO details.
- 3/4" thick.
- Finished on front and all edges (backs are unfinished).
- Waldron PureStyle™ overlays will be painted hardwood.

Species Availability

Hickory	Maple	Oak	Painted	Rustic Hickory	Laminate
•	•	•	•	•	•

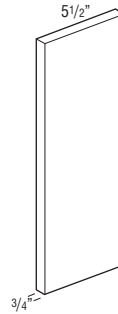

Model	Modified Full Overlay Height
OL630MFO	28 3/4"
OL633MFO	31 3/4"
OL636MFO	34 3/4"
OL639MFO	37 3/4"
OL642MFO	40 3/4"
OL684MFO	78 1/4"
OL687MFO	81 1/4"
OL690MFO	84 1/4"
OL693MFO	87 1/4"
OL696MFO	90 1/4"

Angled Plain 3" Wide Reversible Fillers

BLVDFF30 3" x 30"	164
BLVDFF34.5 3" x 34 1/2"	193

Species Availability

Hickory	Maple	Oak	Painted	Rustic Hickory	Laminate
•	•	•	•	Hickory	Painted

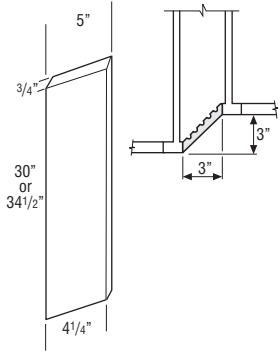

Column Box Fillers, 3" Wide — Wall - 15" Deep

CB33015PL	273
CB33315PL	316
CB33615PL	316
CB33915PL	341
CB34215PL	370

- Not intended for use horizontally as shelving. Use Floating Shelves on page 84.
- Enclosed top and bottom (not finished).
- FPEB construction.

Species Availability

Hickory	Maple	Oak	Painted	Rustic Hickory	Laminate
•	•	•	•	Hickory	Painted

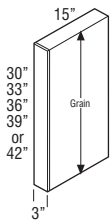

Modifications

ID	RD
•	•

Column Box Fillers, 3" Wide — Base - 27" Deep

CB334.527PL	646
--------------------	-----

- Not intended for use horizontally as shelving. Use Floating Shelves on page 84.
- Enclosed top and bottom (not finished).
- FPEB construction.

Modifications

RD
•

Species Availability

Hickory	Maple	Oak	Painted	Rustic Hickory	Laminate
•	•	•	•	Hickory	Painted

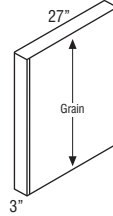

Column Box Fillers, 3" Wide — Tall - 15" or 27" Deep

CB38415PL	591
CB38715PL	633
CB39015PL	633
CB39315PL	677
CB39615PL	726
CB38427PL	817
CB38727PL	875
CB39027PL	875
CB39327PL	935
CB39627PL	1000

- Not intended for use horizontally as shelving. Use Floating Shelves on page 84.
- Enclosed top and bottom (not finished).
- FPEB construction.

Modifications

ID	RD
•*	•

Species Availability

Hickory	Maple	Oak	Painted	Rustic Hickory	Laminate
•	•	•	•	Hickory	Painted

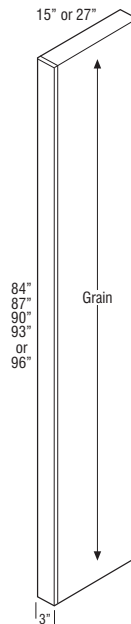

*ID available only on 15" deep.

Dishwasher End Panels

DWEP1.5	132
DWEP3	185
DWEP1.5WD	199
DWEP3WD	252
DWEP1.5FPE	307
DWEP3FPE	360

- DWEP_ constructed of 1/2" thick laminated furniture board.
- DWEP_WD: 1/2" thick veneered plywood.
- DWEP_FPE is 3/4" thick veneered plywood.
- ID27 and ID30 available. RD12, RD15, RD18 and RD21 available.

Modifications

ID	MI	RD
•	•*	•

*MI available only on DWEP_WD and DWEP_FPE.

Species Availability

Hickory	Maple	Oak	Painted	Rustic Hickory	Laminate
•	•	•	•	Hickory	Painted

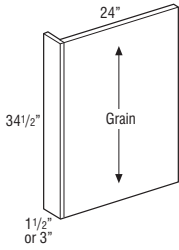

End Panel Skins

WBEP	134
WTEP1284	193
WTEP1296	222
WTEP84	321
WTEP96	370
WTEP108†	556
WWEP30	64
WWEP33	75
WWEP36	75
WWEP39	82
WWEP42	86
WWEP48	101

- Paints will be constructed of MDF.
- 1/4" thick wood veneered, MDF core.
- 12" deep panels - ID15, ID18, ID21, ID24, ID27, and ID30 available. RD9, RD6 available.
- 21" deep panels - ID24, ID27, and ID30 available. RD12, RD15, and RD18 available.
- 24" deep panels - ID27 and ID30 available. RD12, RD15, RD18, and RD21 available.

†WTEP108 only available in Maple and Painted Hardwood. ID not available on 108" panels.

Modifications

ID	RD
•	•

Species Availability

Hickory	Maple	Oak	Painted	Rustic Hickory	Laminate
•	•	•	•	Hickory	Painted

LBEP	54
LTEP1284	70
LTEP1296	114
LTEP84	116
LTEP96	127
LWEP30	25
LWEP33	27
LWEP36	27
LWEP39	30
LWEP42	35
LWEP48	45

- 1/4" thick laminated plywood.
- 12" deep panels - ID15, ID18, ID21, ID24, ID27, and ID30 available. RD9, RD6 available.
- 21" deep panels - ID24, ID27, and ID30 available. RD12, RD15, and RD18 available.
- 24" deep panels - ID27 and ID30 available. RD12, RD15, RD18, and RD21 available.

Modifications

ID	RD
•	•

Species Availability

Hickory	Maple	Oak	Painted	Rustic Hickory	Laminate
•	•	•	•	Hickory	Painted

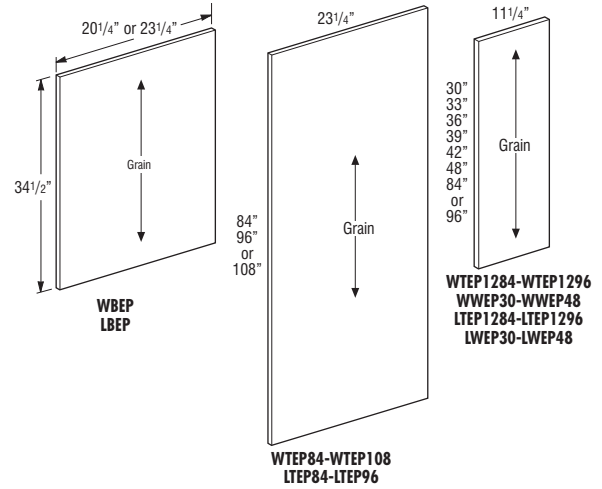

Cross Grain Veneer Back Skin

W9634.5BP	581
W9648BP	645

- 1/4" thick wood veneered, MDF core.
- 93" wide x 34 1/2" or 45" high usable material.

W48X30	284
W48X34.5	315

- Paints will be constructed of MDF.
- 1/4" thick wood veneered, MDF core.

L48X30	104
L48X34.5	116

- 1/4" thick laminated plywood.

Species Availability

Hickory	Maple	Oak	Painted	Rustic Hickory	Laminate
•	•	•	•*	Hickory	Painted

*W96_BP SKUs not available in Painted.

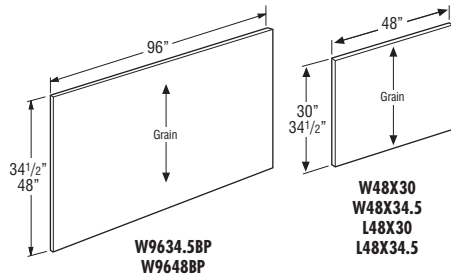

Finished Back Skins

W4896	583
--------------	-----

- Paints will be constructed entirely of MDF.
- 1/4" thick wood veneered, MDF core.

L4896	192
--------------	-----

- 1/4" thick laminated plywood.

Species Availability

Hickory	Maple	Oak	Painted	Rustic Hickory	Laminate
•	•	•	•	Hickory	Painted

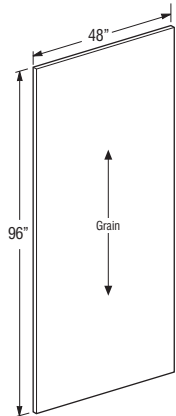

Wood V-grooved Beaded Skin

W4834.5BB	371
W4896BB	852

- 1/4" veneer on MDF core.
- V-groove on 3" centers.

Species Availability

Hickory	Maple	Oak	Painted	Rustic Hickory	Laminate
•	•	•	•	Hickory	Painted

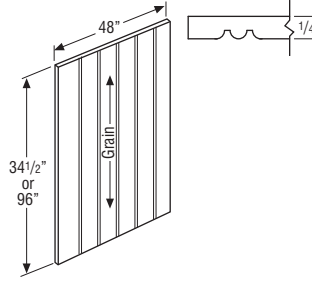

End Panels

SE24 61

- SE24 1/2" thick laminated furniture board.
- Edges are not finished.
- Matching laminate one side and Natural Maple laminate on the other side.
- ID27 and ID30 available. RD12, RD15, RD18, and RD21 available.

Modifications

ID	RD
•	•

Species Availability

Hickory	Maple	Oak	Painted	Rustic Hickory	Laminate
•	•	•	•	•	Painted

SE24WD 111

- SE24WD 1/2" thick veneered plywood.
- Edges are not finished.
- Finished one side and Natural Maple laminate on the other side.
- ID27 and ID30 available. RD12, RD15, RD18, and RD21 available.

Modifications

ID	RD
•	•

Species Availability

Hickory	Maple	Oak	Painted	Rustic Hickory	Laminate
•	•	•	•	•	Painted

SP1230	169
SP1248	188
SP1296	371
SP12108[†]	575
SP2434.5	211
SP2484	547
SP2487	567
SP2490	587
SP2493	607
SP2496	627
SP24108[†]	970
SP3084	682
SP3096	785

- 3/4" thick veneered furniture board finished on both sides and front edge.
- 12" deep panels - ID15, ID18, ID21, ID24, ID27, and ID30 available. RD9, RD6 available.
- 24" deep panels - ID27 and ID30 available. RD12, RD15, RD18, and RD21 available.
- 30" deep panels - RD27 available.

Modifications

APU	ID	RD
•	•	•

[†]SP12108 and SP24108 only available in Maple and Painted Hardwood. ID not available on 108" panels. 3/4" thick veneered plywood.

Species Availability

Hickory	Maple	Oak	Painted	Rustic Hickory	Laminate
•	•	•	•	Hickory	Painted

LSP1230	84
LSP1248	105
LSP1296	203
LSP2434.5	141
LSP2484	315
LSP2487	335
LSP2490	354
LSP2493	373
LSP2496	392
LSP3084	360
LSP3096	450

- 3/4" thick laminated furniture board.
- LSP panels are only available in Alpine.
- 12" deep panels - ID15, ID18, ID21, ID24, ID27, and ID30 available. RD9, RD6 available.
- 24" deep panels - ID27 and ID30 available. RD12, RD15, RD18, and RD21 available.
- 30" deep panels - RD27 available.

Modifications

ID	RD
•	•

Species Availability

Hickory	Maple	Oak	Painted	Rustic Hickory	Laminate
•	•	•	•	•	Painted

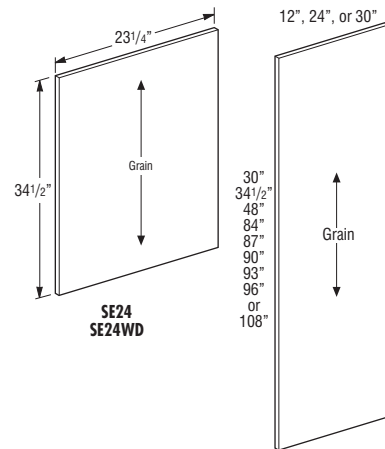

**LSP/SP1230-LSP/SP1296
LSP/SP2434.5-LSP/SP2496
LSP/SP3084-LSP/SP3096
SP12108, SP24108**

Refrigerator Panels with Filler Attached

WREP1.52484	616
WREP1.52487	666
WREP1.52490	666
WREP1.52493	707
WREP1.52496	707
WREP1.524108†	1060
WREP32484	668
WREP32487	712
WREP32490	712
WREP32493	762
WREP32496	762
WREP324108†	1144

- 1/2" thick plywood.
 - 1/4" reveal on filler at panel attachment.
 - Total panel depth includes 3/4" thick filler. Example: WREP1.52484 = panel depth of 24".
 - 24" deep panels - ID27 and ID30 available. RD12, RD15, RD18 and RD21 available.
- †WREP1.524108 and WREP324108 only available in Maple and Painted Hardwood. ID and MI not available on 108" panels.

Modifications

ID	MI	RD
•	•	•

Species Availability

Hickory	Maple	Oak	Painted	Rustic Hickory	Laminate
•	•	•	•	Hickory	Painted

LREP1.52484	236
LREP1.52487	256
LREP1.52490	256
LREP1.52493	275
LREP1.52496	275
LREP32484	261
LREP32487	283
LREP32490	283
LREP32493	299
LREP32496	299

- 1/2" thick laminated furniture board.
- 1/4" reveal on filler at panel attachment.
- Total panel depth includes 3/4" thick filler. Example: LREP1.52484 = panel depth of 24".
- 24" deep panels - ID27 and ID30 available. RD12, RD15, RD18 and RD21 available.

Modifications

ID	RD
•	•

Species Availability

Hickory	Maple	Oak	Painted	Rustic Hickory	Laminate
•	•	•	•	Hickory	Painted

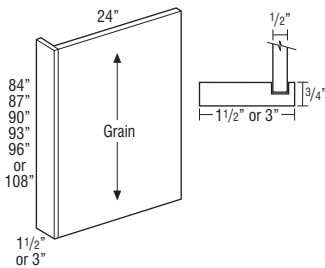

Refrigerator Panels with Filler Attached and Furniture Ends

WREP1.52484FPE	727
WREP1.52487FPE	786
WREP1.52490FPE	786
WREP1.52493FPE	834
WREP1.52496FPE	834
WREP1.524108FPE†	1251
WREP32484FPE	788
WREP32487FPE	840
WREP32490FPE	840
WREP32493FPE	899
WREP32496FPE	899
WREP324108FPE†	1350

- 3/4" thick plywood.
 - Total panel depth includes 3/4" thick filler. Example: WREP1.52484FPE = panel depth of 24".
 - 24" deep panels - ID27 and ID30 available. RD12, RD15, RD18 and RD21 available.
- †WREP1.524108FPE and WREP324108FPE only available in Maple and Painted Hardwood with MI standard. ID not available on 108" panels.

Modifications

FPEB	ID	MI	RD
STD	•	•	•

Species Availability

Hickory	Maple	Oak	Painted	Rustic Hickory	Laminate
•	•	•	•	Hickory	Painted

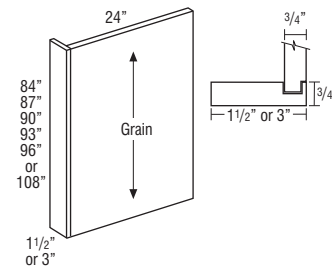

Decorative Door Panel Kit — Wall End

WDOP30	210
WDOP33	247
WDOP36	247
WDOP39	269
WDOP42	293

- Door panel kits include 1/4" thick veneer wood panels and door with attachment screws for field installation.
- Door and panel shipped unattached for full/modified full overlay styles.

Modifications

FULL/MFO
•

Species Availability

Hickory	Maple	Oak	Painted	Rustic Hickory	Laminate
•	•	•	•	•	•

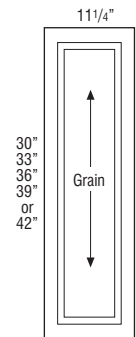

Decorative Door Panel Kit — Base End

BDOP

403

- Door panel kits include 1/4" thick veneer wood panels and door with attachment screws for field installation.
- Door and panel shipped unattached for full/modified full overlay styles.

Species Availability

Hickory	Maple	Oak	Painted	Rustic Hickory	Laminate
•	•	•	•	•	•

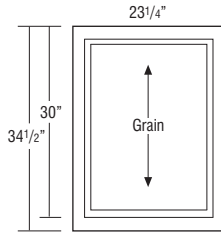

Decorative Door Panel Kit — Tall End

TDOP2484

1016

TDOP2487

1060

TDOP2490

1060

TDOP2493

1123

TDOP2496

1123

- Door panel kits include 1/4" thick veneer wood panels and door with attachment screws for field installation.
- Door and panel shipped unattached for full/modified full overlay styles.
- TDOP configuration will match the front of the cabinet.

Modifications

FULL/MFO
•

Species Availability

Hickory	Maple	Oak	Painted	Rustic Hickory	Laminate
•	•	•	•	•	•

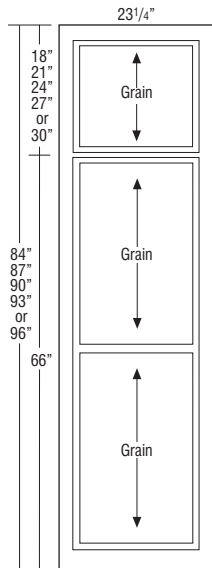

Vanity Desk Legs

DL

233

VDL

237

- All panels are finished 2 sides and front edge.
- 3/4" thick veneered furniture board.

Species Availability

Hickory	Maple	Oak	Painted	Rustic Hickory	Laminate
•	•	•	•	Hickory	Painted

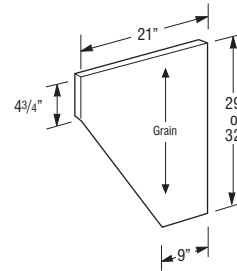

Toekick Overlay

WT04.5 (4 7/16" x 96" x 1/4")

60

- Points will be constructed entirely of MDF.
- 1/4" thick plywood finished veneer.
- One 8' section.

LTO4.5 (4 7/16" x 96" x 1/4" Laminate)

38

- 1/4" thick laminated furniture board.
- One 8' section.

Species Availability

Hickory	Maple	Oak	Painted	Rustic Hickory	Laminate
•	•	•	•	Hickory	Painted

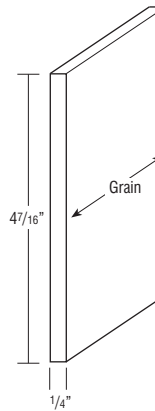

Crown Moulding — Classic Tall Crown

CLTCROWN8

348

- One 8' section.
- Cleat shipped unattached, can be used for top mount or face frame applications. For top mount applications on stained finishes, it is not recommended to pull the moulding forward with the cleat visible due to possible color variation with the face frame and moulding.

Species Availability

Hickory	Maple	Oak	Painted	Rustic Hickory	Laminate
•	•	•	•	Hickory	Painted

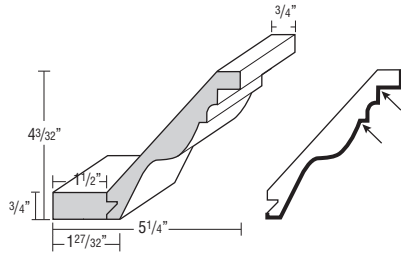

NEW Crown Moulding — Cornice Tall Crown

COTCROWN8

348

- One 8' section.
- Cleat shipped unattached, can be used for top mount or face frame applications. For top mount applications on stained finishes, it is not recommended to pull the moulding forward with the cleat visible due to possible color variation with the face frame and moulding.

Species Availability

Hickory	Maple	Oak	Painted	Rustic Hickory	Laminate
•	•	•	•	•	Painted

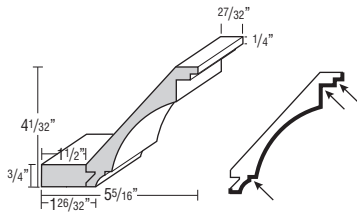

Crown Moulding — Cove Crown

COVECROWN8

348

- One 8' section.
- Cleat shipped unattached, can be used for top mount or face frame applications. For top mount applications on stained finishes, it is not recommended to pull the moulding forward with the cleat visible due to possible color variation with the face frame and moulding.

Species Availability

Hickory	Maple	Oak	Painted	Rustic Hickory	Laminate
•	•	•	•	Hickory	Painted

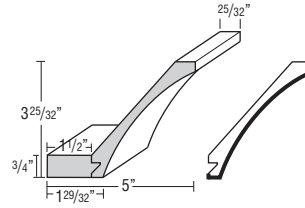

Crown Moulding — Insert Crown

INSCROWN

390

- One 8' section.

Species Availability

Hickory	Maple	Oak	Painted	Rustic Hickory	Laminate
	•	•	•		Painted

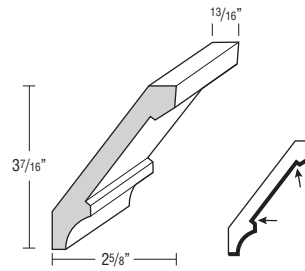

Crown Moulding — Large Crown

LCROWN8

317

- One 8' section.

Species Availability

Hickory	Maple	Oak	Painted	Rustic Hickory	Laminate
•	•	•	•	Hickory	Painted

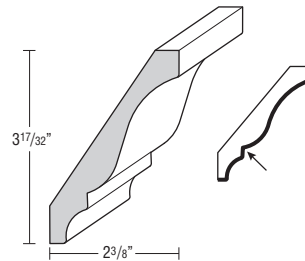

Mouldings specified as 8' nominal length have a usable length range of 93" up to 99". Be sure to order the correct amount of moulding length to work around required cuts with minimal butt joints.

Finished edges indicated by bold lines on side view drawings.
Glazed edges indicated by arrows on side view drawings.

Crown Moulding — Large Straight Angle Crown

LSACROWN8

390

- One 8' section.
- Cleat shipped unattached, can be used for top mount or face frame applications. For top mount applications on stained finishes, it is not recommended to pull the moulding forward with the cleat visible due to possible color variation with the face frame and moulding.

Species Availability

Hickory	Maple	Oak	Painted	Rustic Hickory	Laminate
•	•	•	•	Hickory	Painted

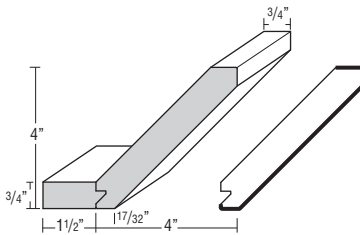

Crown Moulding — Medium Straight Angle Crown

MSACROWN8

271

- One 8' section.
- Cleat shipped unattached, can be used for top mount or face frame applications. For top mount applications on stained finishes, it is not recommended to pull the moulding forward with the cleat visible due to possible color variation with the face frame and moulding.

Species Availability

Hickory	Maple	Oak	Painted	Rustic Hickory	Laminate
•	•	•	•	Hickory	Painted

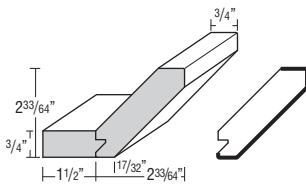

Crown Moulding — Shaker Crown

LSHAKER

192

NSHAKER

186

- One 8' section.
- NSHAKER is a top mount moulding.

Species Availability

Hickory	Maple	Oak	Painted	Rustic Hickory	Laminate
•	•	•	•	Hickory	Painted

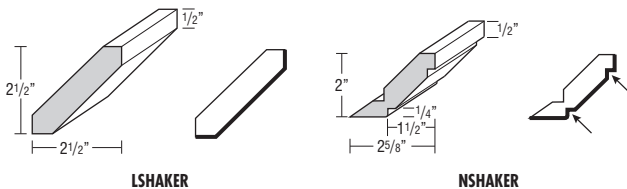

Mouldings specified as 8' nominal length have a usable length range of 93" up to 99". Be sure to order the correct amount of moulding length to work around required cuts with minimal butt joints.

Finished edges indicated by bold lines on side view drawings.
Glazed edges indicated by arrows on side view drawings.

Crown Moulding — Small Cove Crown

SMCOVECROWN8

271

- One 8' section.

Species Availability

Hickory	Maple	Oak	Painted	Rustic Hickory	Laminate
•	•	•	•	Hickory	Painted

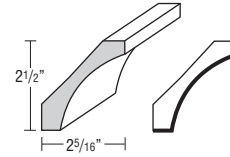

Crown Moulding — Small Crown

SCM8

135

- One 8' section.

Species Availability

Hickory	Maple	Oak	Painted	Rustic Hickory	Laminate
•	•	•	•	•	Painted

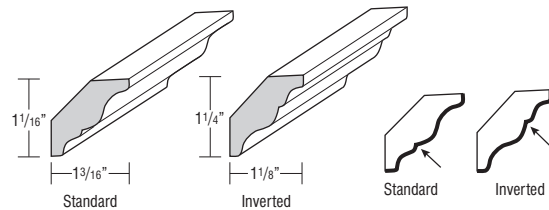

Crown Moulding — Solid-wood Small Crown

SCROWN8

142

- One 8' section.

Species Availability

Hickory	Maple	Oak	Painted	Rustic Hickory	Laminate
•	•	•	•	Hickory	Painted

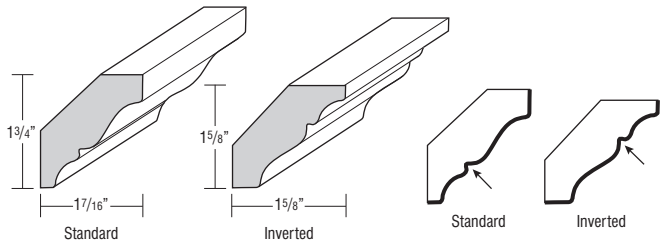

Crown Moulding — Solid-wood Large Crown

SWLCRM8

261

- One 8' section.

Species Availability

Hickory	Maple	Oak	Painted	Rustic Hickory	Laminate
•	•	•	•	Hickory	Painted

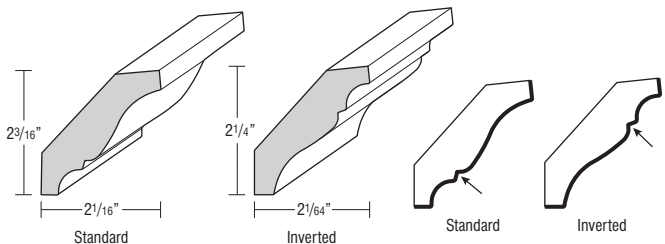

Crown Moulding — Solid-wood Victorian Crown

SWVCRM8

317

- One 8' section.

Species Availability

Hickory	Maple	Oak	Painted	Rustic Hickory	Laminate
•	•	•	•	Hickory	Painted

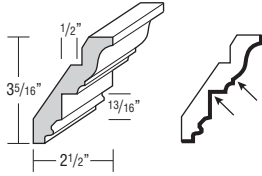

Crown Moulding — Straight Angle Crown

SACROWN8

235

- One 8' section.
- Cleat shipped unattached, can be used for top mount or face frame applications. For top mount applications on stained finishes, it is not recommended to pull the moulding forward with the cleat visible due to possible color variation with the face frame and moulding.

Species Availability

Hickory	Maple	Oak	Painted	Rustic Hickory	Laminate
•	•	•	•	Hickory	Painted

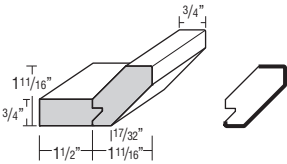

Crown Moulding — Tall Crown

SWTCRM8

236

- One 8' section.

Species Availability

Hickory	Maple	Oak	Painted	Rustic Hickory	Laminate
•	•	•	•	Hickory	Painted

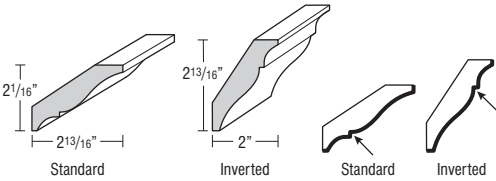

Mouldings specified as 8' nominal length have a usable length range of 93" up to 99". Be sure to order the correct amount of moulding length to work around required cuts with minimal butt joints.

Finished edges indicated by bold lines on side view drawings.
Glazed edges indicated by arrows on side view drawings.

Starter Moulding — Soffit Filler Moulding

SFM8

378

- One 8' section.
- Cleat shipped unattached, can be used for top mount or face frame applications. For top mount applications on stained finishes, it is not recommended to pull the moulding forward with the cleat visible due to possible color variation with the face frame and moulding.

Species Availability

Hickory	Maple	Oak	Painted	Rustic Hickory	Laminate
•	•	•	•	Hickory	Painted

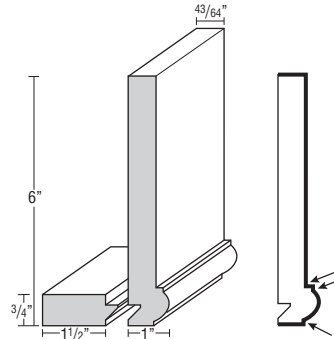

Starter Moulding — Starter Moulding

STR8

323

- One 8' section.
- Attached cleat for top-mount application.

Species Availability

Hickory	Maple	Oak	Painted	Rustic Hickory	Laminate
•	•	•	•	Hickory	Painted

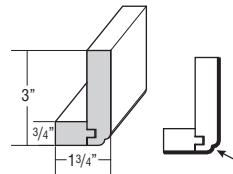

Starter Moulding — Starter Moulding Shaker

STRS8

323

- One 8' section.
- Attached cleat for top-mount application.

Species Availability

Hickory	Maple	Oak	Painted	Rustic Hickory	Laminate
•	•	•	•	Hickory	Painted

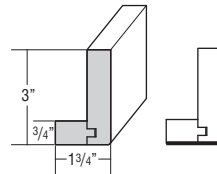

Accent Moulding — Baseboard

BBM8

245

- One 8' section.

Species Availability

Hickory	Maple	Oak	Painted	Rustic Hickory	Laminate
•	•	•	•	Hickory	Painted

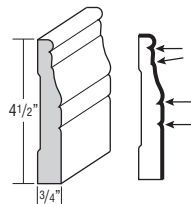

Accent Moulding — Baseboard Shaker

BBMSH8

245

- One 8' section.

Species Availability

Hickory	Maple	Oak	Painted	Rustic Hickory	Laminate
•	•	•	•	Hickory	Painted

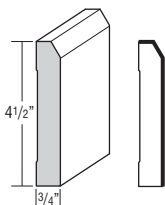

Accent Moulding — Batten

BATTEN8

56

- One 8' section.

Species Availability

Hickory	Maple	Oak	Painted	Rustic Hickory	Laminate
•	•	•	•	Hickory	Painted

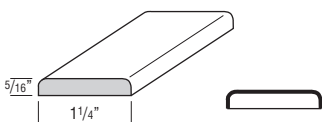

Accent Moulding — Batten Small

SM8

46

- One 8' section.

Species Availability

Hickory	Maple	Oak	Painted	Rustic Hickory	Laminate
•	•	•	•	Hickory	Painted

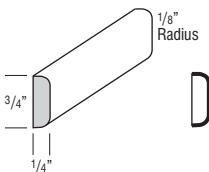

Mouldings specified as 8' nominal length have a usable length range of 93" up to 99". Be sure to order the correct amount of moulding length to work around required cuts with minimal butt joints.

Finished edges indicated by bold lines on side view drawings.
Glazed edges indicated by arrows on side view drawings.

Accent Moulding — Chair Rail

CHAIR

105

- One 8' section.

Species Availability

Hickory	Maple	Oak	Painted	Rustic Hickory	Laminate
•	•	•	•	Hickory	Painted

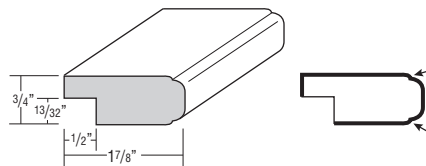

Accent Moulding — Furniture Base

FB8

245

- One 8' section.

Species Availability

Hickory	Maple	Oak	Painted	Rustic Hickory	Laminate
•	•	•	•	Hickory	Painted

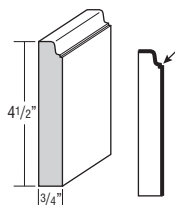

Accent Moulding — Library Moulding

LIBRARY

245

- One 8' section.

Species Availability

Hickory	Maple	Oak	Painted	Rustic Hickory	Laminate
•	•	•	•	Hickory	Painted

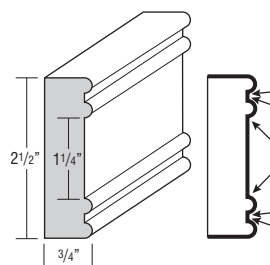

Accent Moulding — Mirror Frame

MRM

112

- Pre-grooved.
- One 8' section.

Species Availability

Hickory	Maple	Oak	Painted	Rustic Hickory	Laminate
•	•	•	•	Hickory	Painted

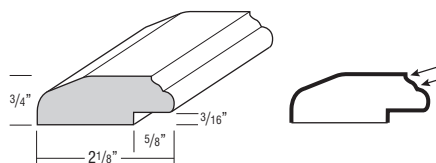

Accent Moulding — Ogee Edge

OJM

86

- One 8' section.

Species Availability

Hickory	Maple	Oak	Painted	Rustic Hickory	Laminate
•	•	•	•	Hickory	Painted

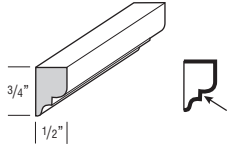

Accent Moulding — Single Bead

SB8

153

- One 8' section.

Species Availability

Hickory	Maple	Oak	Painted	Rustic Hickory	Laminate
•	•	•	•	Hickory	Painted

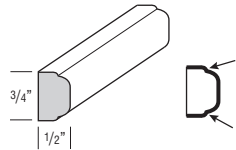

Accent Moulding — Small Scribe

SCRIBE8

50

- One 8' section.

Species Availability

Hickory	Maple	Oak	Painted	Rustic Hickory	Laminate
•	•	•	•	Hickory	Painted

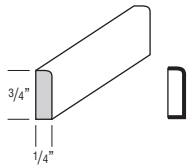

Accent Moulding — Soffit Trim Moulding

TSTM8

157

- One 8' section.

Species Availability

Hickory	Maple	Oak	Painted	Rustic Hickory	Laminate
•	•	•	•	Hickory	Painted

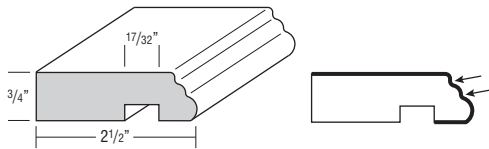

Mouldings specified as 8' nominal length have a usable length range of 93" up to 99". Be sure to order the correct amount of moulding length to work around required cuts with minimal butt joints.

Finished edges indicated by bold lines on side view drawings.
Glazed edges indicated by arrows on side view drawings.

Accent Moulding — Toekick Cap

TKC

32

- Sold in pairs.

Species Availability

Hickory	Maple	Oak	Painted	Rustic Hickory	Laminate
•	•	•	•	Hickory	Painted

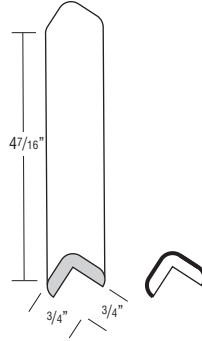

Accent Moulding — Traditional Countertop Edge

TCM8

84

- One 8' section.

Species Availability

Hickory	Maple	Oak	Painted	Rustic Hickory	Laminate
•	•	•	•	Hickory	Painted

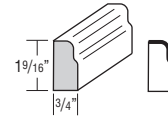

Accent Moulding — Triple Bead Edge

TB

153

- One 8' section.

Species Availability

Hickory	Maple	Oak	Painted	Rustic Hickory	Laminate
•	•	•	•	Hickory	Painted

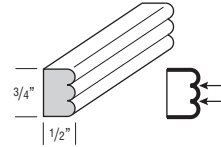

Accent Moulding — Triple Bead Pilaster

TBP8

284

- Finished beaded front and two 4 1/2" sides.
- Can be used vertically between cabinets for an inset look.
- One 8' section.

Species Availability

Hickory	Maple	Oak	Painted	Rustic Hickory	Laminate
•	•	•	•	Hickory	Painted

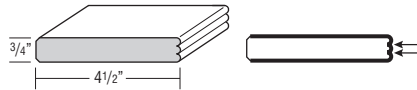

Light Rails — Cap Moulding

CAPM 105

SOFFITA 105

SOFFITE 105

- One 8' section.
- SOFFITA and SOFFITE must be shimmed at the notch or used with an under-cabinet skin if used with full/modified full overlay styles.

Species Availability

Hickory	Maple	Oak	Painted	Rustic Hickory	Laminate
•	•	•	•	Hickory	Painted

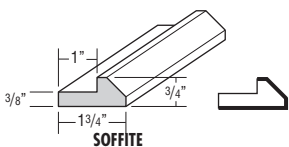
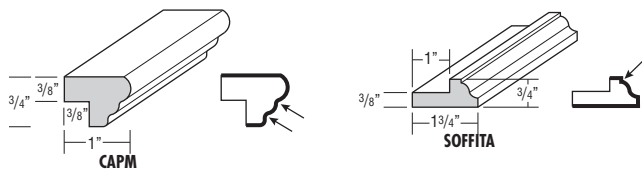

Light Rails — Furniture Base

FB2 86

- One 8' section.

Species Availability

Hickory	Maple	Oak	Painted	Rustic Hickory	Laminate
•	•	•	•	Hickory	Painted

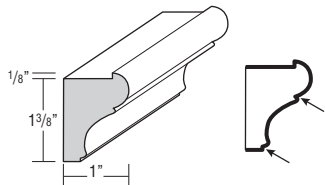

Light Rails — Light Baffle

LB2 105

- One 8' section.

Species Availability

Hickory	Maple	Oak	Painted	Rustic Hickory	Laminate
•	•	•	•	Hickory	Painted

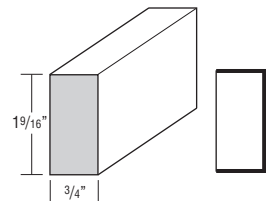

Mouldings specified as 8' nominal length have a usable length range of 93" up to 99". Be sure to order the correct amount of moulding length to work around required cuts with minimal butt joints.

Finished edges indicated by bold lines on side view drawings.
Glazed edges indicated by arrows on side view drawings.

Light Rails — Light Rail Moulding

LRM 346

- One 8' section.

Species Availability

Hickory	Maple	Oak	Painted	Rustic Hickory	Laminate
•	•	•	•	Hickory	Painted

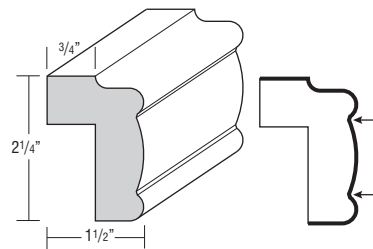

Light Rails — Small Light Rail Moulding

SMLR 311

- One 8' section.

Species Availability

Hickory	Maple	Oak	Painted	Rustic Hickory	Laminate
•	•	•	•	Hickory	Painted

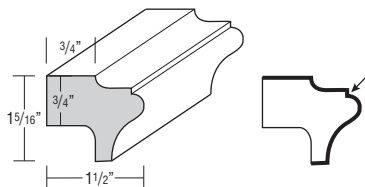

Light Rails — Valley Forge

VFR8 105

- One 8' section.
- Must be shimmed at the notch or used with an under-cabinet skin if used with full/modified full overlay styles.

Species Availability

Hickory	Maple	Oak	Painted	Rustic Hickory	Laminate
•	•	•	•	Hickory	Painted

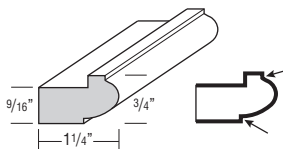

Corner Mouldings — Inside Corner

ISC8

67

- One 8' section.

Species Availability

Hickory	Maple	Oak	Painted	Rustic Hickory	Laminate
•	•	•	•	Hickory	Painted

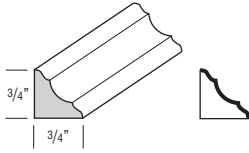

Corner Mouldings — Outside Corner

OCM8

67

- One 8' section.

Species Availability

Hickory	Maple	Oak	Painted	Rustic Hickory	Laminate
•	•	•	•	Hickory	Painted

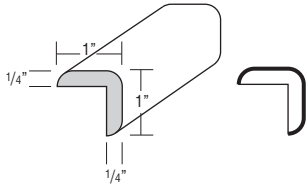

Corner Mouldings — Outside Corner Small

SOCM8

60

- One 8' section.

Species Availability

Hickory	Maple	Oak	Painted	Rustic Hickory	Laminate
•	•	•	•	Hickory	Painted

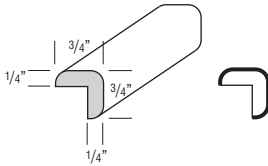

Corner Mouldings — Outside Corner 135°

OSC135

211

- One 8' section.

Species Availability

Hickory	Maple	Oak	Painted	Rustic Hickory	Laminate
•	•	•	•	Hickory	Painted

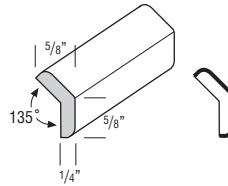

Corner Mouldings — Quarter Round

QRM

67

- One 8' section.

Species Availability

Hickory	Maple	Oak	Painted	Rustic Hickory	Laminate
•	•	•	•	Hickory	Painted

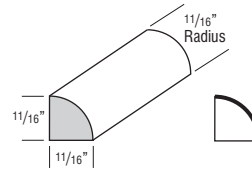

Corner Mouldings — Shoe - Convex Inside Corner

SHM8

86

- One 8' section.

Species Availability

Hickory	Maple	Oak	Painted	Rustic Hickory	Laminate
•	•	•	•	Hickory	Painted

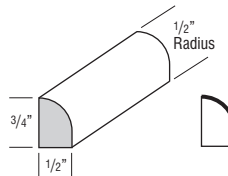

Mouldings specified as 8' nominal length have a usable length range of 93" up to 99". Be sure to order the correct amount of moulding length to work around required cuts with minimal butt joints.

Finished edges indicated by bold lines on side view drawings.
Glazed edges indicated by arrows on side view drawings.

Arched Valance

AV36	116
AV48	138
AV60	159
AV72	193

- Side shoulders are 8" wide (6" trimmable each end).
- Bottom edge has 3/16" radius.
- 3/4" thick.

Species Availability

Hickory	Maple	Oak	Painted	Rustic Hickory	Laminate
•	•	•	•	Hickory	Painted

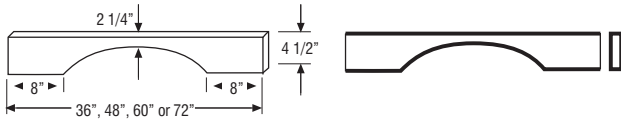

Decorative Arch Valance

DAV36	1168
DAV42	1226

- Trimmable up to 1 3/4" per side and top and bottom.
- Center height 8".

Species Availability

Hickory	Maple	Oak	Painted	Rustic Hickory	Laminate
•	•	•	•	Hickory	Painted

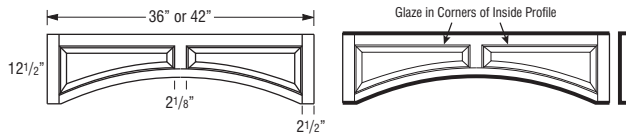

Finished edges indicated by bold lines on side view drawings.
Glazed edges indicated by arrows on side view drawings.

Furniture Valance

FV36	113
FV48	137
FV60	156
FV72	166

- Side shoulders are 8" wide (6" trimmable each end).
- Bottom edge has 3/16" radius profile on face.
- 3/4" thick.

Species Availability

Hickory	Maple	Oak	Painted	Rustic Hickory	Laminate
•	•	•	•	Hickory	Painted

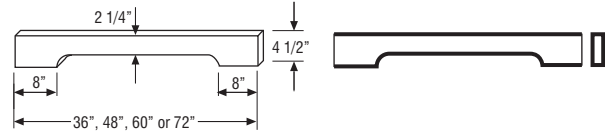

Straight Valance

SV48	115
SV96	228

- Trimmable.
- Profiled bottom edge.
- 3/4" thick.

Species Availability

Hickory	Maple	Oak	Painted	Rustic Hickory	Laminate
•	•	•	•	Hickory	Painted

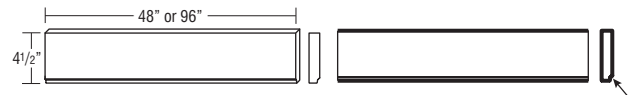

Decorative Supports — English Bar Column

ENGBARCOLUMN 913

- Trimtable.

Species Availability

Hickory	Maple	Oak	Painted	Rustic Hickory	Laminate
•	•	•	•	Hickory	Painted

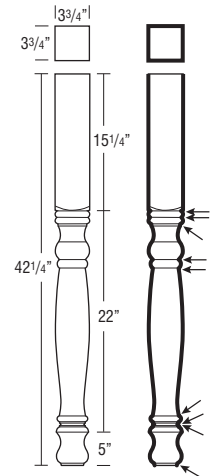

Decorative Supports — English Country Leg

JENGCNTYLEG 724

- Trimtable.

Species Availability

Hickory	Maple	Oak	Painted	Rustic Hickory	Laminate
•	•	•	•		Painted

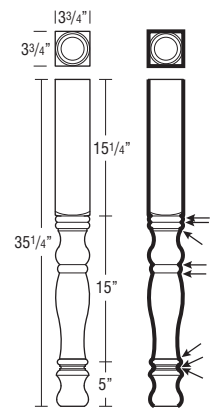

Finished edges indicated by bold lines on side view drawings.
Glazed edges indicated by arrows on side view drawings.

Decorative Supports — English Island Column

ENGISLCOLUMN 994

- Trimtable.

Species Availability

Hickory	Maple	Oak	Painted	Rustic Hickory	Laminate
•	•	•	•	Hickory	Painted

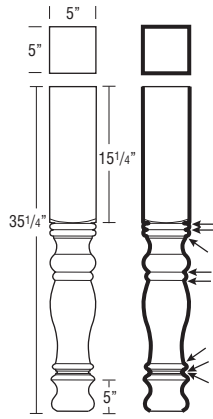

Decorative Supports — Estate Leg

JESTATELEGS 708

- Trimtable.

Species Availability

Hickory	Maple	Oak	Painted	Rustic Hickory	Laminate
•	•	•	•		Painted

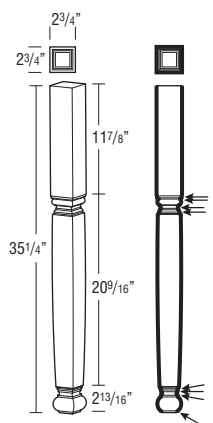

Decorative Supports — Island Leg, 2-Sided or 4-Sided

2SISLLEG 930

4SISLLEG 1045

- Trimable.

Species Availability

Hickory	Maple	Oak	Painted	Rustic Hickory	Laminate
•	•	•	•	Hickory	Painted

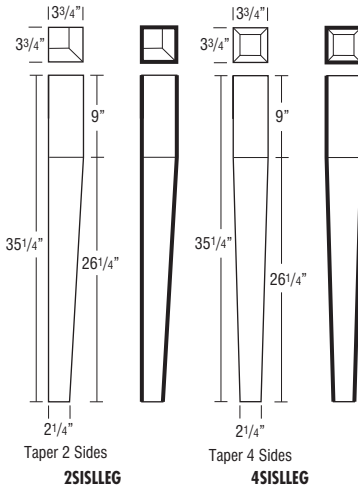

Decorative Supports — Island Leg Tapered

ISLEGTPRD 914

- Trimable.

Species Availability

Hickory	Maple	Oak	Painted	Rustic Hickory	Laminate
	•		•		Painted

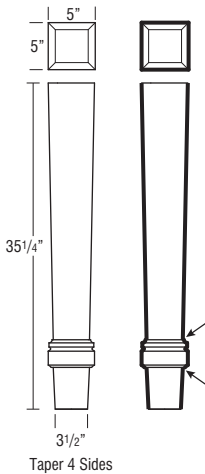

Finished edges indicated by bold lines on side view drawings.
Glazed edges indicated by arrows on side view drawings.

Decorative Supports — Metro Column

METISLCOLUMN

1003

- Trimable.
- Leg is designed with three pieces joined together.

Species Availability

Hickory	Maple	Oak	Painted	Rustic Hickory	Laminate
	•	•	•		Painted

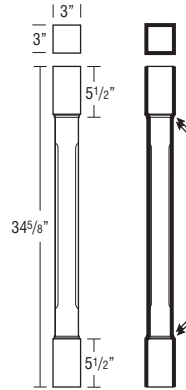

Decorative Supports — Mission Leg

DLEGMSSION

914

- Trimable.

Species Availability

Hickory	Maple	Oak	Painted	Rustic Hickory	Laminate
•	•	•	•	Hickory	Painted

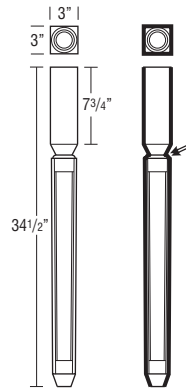

Decorative Supports — Spool Leg

SPLEG 708

- Trimable.

Species Availability

Hickory	Maple	Oak	Painted	Rustic Hickory	Laminate
•	•	•	•		Painted

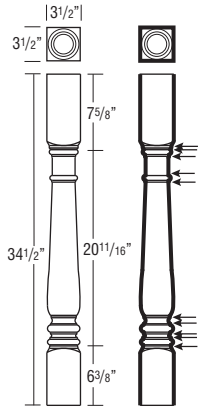

Decorative Supports — Square Island Leg

SQISLLEG3 658

SQISLLEG4 759

SQISLLEG5 874

- Trimable.

Species Availability

Hickory	Maple	Oak	Painted	Rustic Hickory	Laminate
•	•	•	•	Hickory	Painted

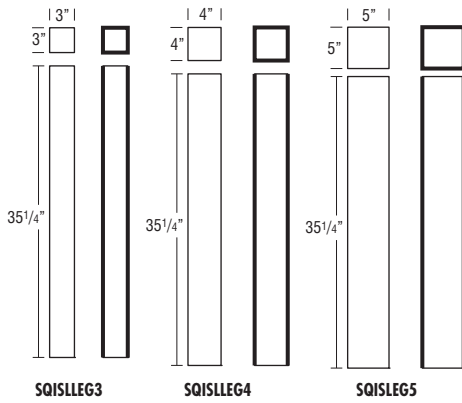

Finished edges indicated by bold lines on side view drawings.
 Glazed edges indicated by arrows on side view drawings.

Decorative Supports — Turned Post

TURNEDPOST 762

Species Availability

Hickory	Maple	Oak	Painted	Rustic Hickory	Laminate
•	•	•	•	Hickory	Painted

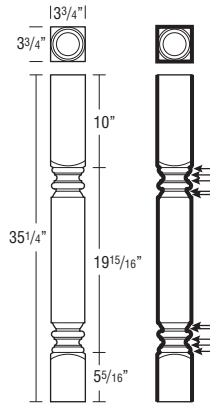

Decorative Supports — Craftsman Foot

JCRAFTFOOT

167

Species Availability

Hickory	Maple	Oak	Painted	Rustic Hickory	Laminate
	•	•	•		Painted

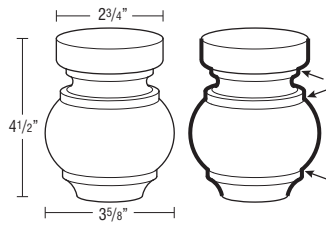

Decorative Supports — Kensington Bun Foot

JCRBUNFOOT

208

Species Availability

Hickory	Maple	Oak	Painted	Rustic Hickory	Laminate
	•	•	•		Painted

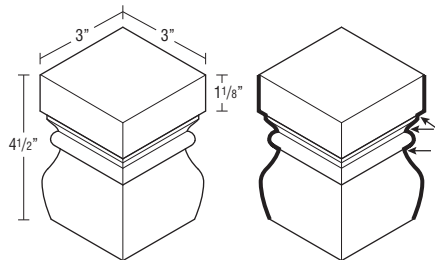

Decorative Supports — Lille Foot

LIFOOT

376

Species Availability

Hickory	Maple	Oak	Painted	Rustic Hickory	Laminate
	•	•	•		Painted

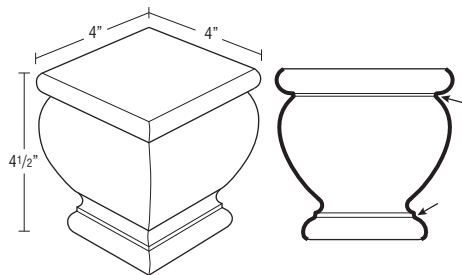

Finished edges indicated by bold lines on side view drawings.
Glazed edges indicated by arrows on side view drawings.

Decorative Supports — Tapered Leg

TAPLG

172

- Trimtable.

Species Availability

Hickory	Maple	Oak	Painted	Rustic Hickory	Laminate
	•		•		Painted

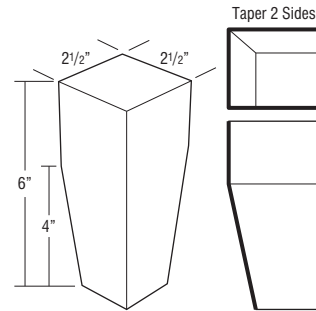

Decorative Supports — Toekick Tulip Foot

TKTLFOOT

208

- Trimtable.

Species Availability

Hickory	Maple	Oak	Painted	Rustic Hickory	Laminate
	•	•	•		Painted

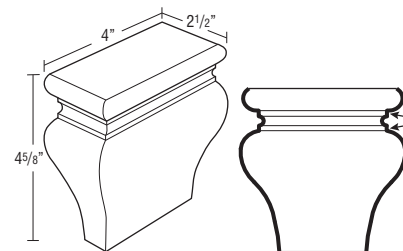

Decorative Supports — Tulip Foot

TLFOOT

321

- Trimtable.

Species Availability

Hickory	Maple	Oak	Painted	Rustic Hickory	Laminate
	•	•	•		Painted

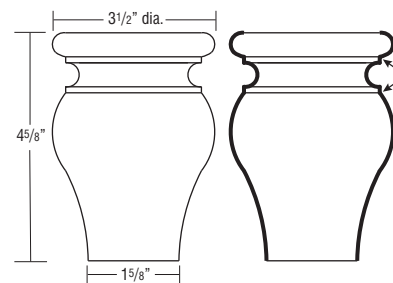

9" Art Corbel

CORBELART9

747

- In order to support substantial weight, corbel must be properly installed with the attachment screws driven in a wall stud.

Species Availability

Hickory	Maple	Oak	Painted	Rustic Hickory	Laminate
	•	•	•		Painted

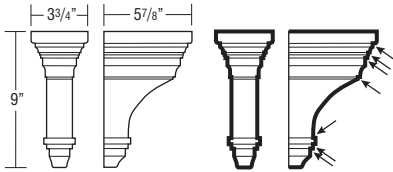

11 1/2" Arts & Crafts Bracket

JBRACKETART

422

- In order to support substantial weight, corbel must be properly installed with the attachment screws driven in a wall stud.

Species Availability

Hickory	Maple	Oak	Painted	Rustic Hickory	Laminate
	•	•	•		Painted

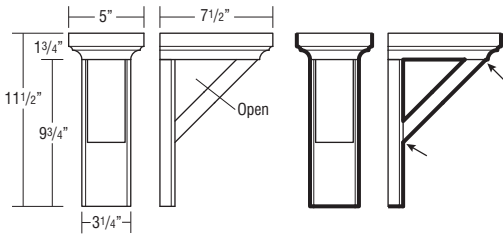

9" Classic Revival Corbel

CORBELCR9

687

- In order to support substantial weight, corbel must be properly installed with the attachment screws driven in a wall stud.

Species Availability

Hickory	Maple	Oak	Painted	Rustic Hickory	Laminate
	•	•	•		Painted

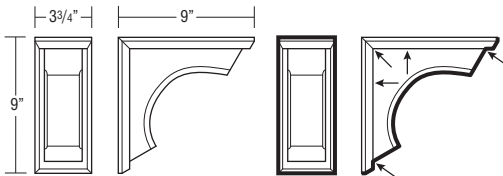

9" Mission Corbel

CORBELMIS9

643

- In order to support substantial weight, corbel must be properly installed with the attachment screws driven in a wall stud.

Species Availability

Hickory	Maple	Oak	Painted	Rustic Hickory	Laminate
	•	•	•		Painted

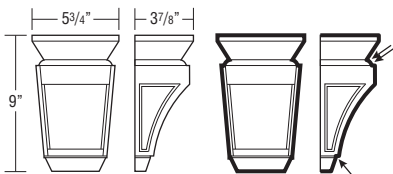

Finished edges indicated by bold lines on side view drawings.
Glazed edges indicated by arrows on side view drawings.

5" Old World Corbel

CORBELOWD5

386

- In order to support substantial weight, corbel must be properly installed with the attachment screws driven in a wall stud.

Species Availability

Hickory	Maple	Oak	Painted	Rustic Hickory	Laminate
	•	•	•		Painted

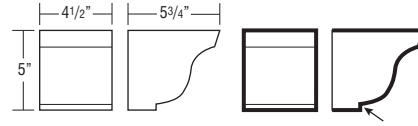

13" Large Scroll Corbel

LGCORBEL

818

- In order to support substantial weight, corbel must be properly installed with the attachment screws driven in a wall stud.

Species Availability

Hickory	Maple	Oak	Painted	Rustic Hickory	Laminate
	•	•	•		Painted

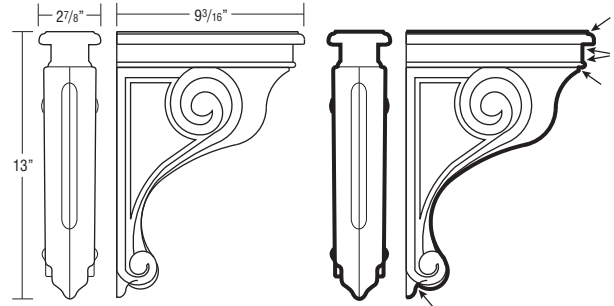

11 1/4" Snack Bar Support

SBS

135

Species Availability

Hickory	Maple	Oak	Painted	Rustic Hickory	Laminate
•	•	•	•	Hickory	Painted

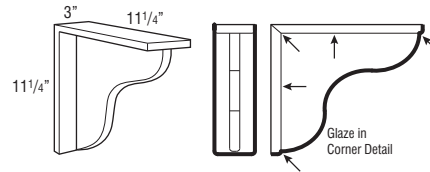

DESCRIPTION	MODEL	PRICE
-------------	-------	-------

Decorative Hardware — Knobs and Pulls

ANTIQUE PEWTER



KNOBM148 16
 L: 2 5/8"
 W: 5/8"
 P: 1 1/4"



KNOBM206 16
 D: 1 1/4"
 P: 1 1/16"



PULLM364 20
 C/C: 3"
 L: 4 5/8"
 W: 1 7/16"
 P: 15/16"



PULLM475 15
 C/C: 3 3/4"
 L: 5"
 W: 9/16"
 P: 1"

BLACK



KNOBT1017 31
 C/C: 1 1/4"
 L: 2"
 W: 1 1/16"
 P: 1 1/4"
 Pairs best with PULLT1015



PULLT1015 44
 C/C: 7"
 L: 8"
 W: 1 1/16"
 P: 1 1/2"
 Pairs best with KNOBT1017



KNOB1912 37
 D: 1 1/4"
 P: 1 3/16"

D = Diameter
P = Projection (Hardware Depth)
L = Length
W = Width
B = Base
C/C = Center to Center

Installation screws included with each hardware piece.
 Breakoff screws available for purchase separately as BRKOFFSCREW, see page 177.
 Larger pulls may not be compatible with 5-piece drawer fronts on face frame openings of 9" wide or less.
 See page 26 for 5-piece drawer front dimensions when specifying decorative hardware.

DESCRIPTION	MODEL	PRICE
-------------	-------	-------

BLACK (cont'd)



KNOBH951 14
 L: 1 3/4"
 W: 1"
 P: 1"
 B: 1 1/16" x 1/2"



PULLH952 27
 C/C: 3"
 L: 4 1/4"
 W: 1 1/2"
 P: 11/16"



PULLM383 27
 C/C: 5 1/16"
 L: 6"
 W: 1/2"
 P: 1 1/16"



KNOBH136 12
 L: 1 3/4"
 W: 1/2"
 P: 1 1/8"
 B: 1/2"



PULLH130 14
 C/C: 128mm
 L: 6 3/8"
 W: 7/16"
 P: 1 1/8"



PULLH132 22
 C/C: 224mm
 L: 10"
 W: 1/2"
 P: 1 3/8"



BLACK IRON





KNOB1901 25
 L: 1 7/16"
 W: 1 1/4"
 P: 1 1/8"
 B: 15/16"



PULL1902 37
 C/C: 128mm
 L: 6 1/3"
 W: 1 1/10"
 P: 1 1/16"



DESCRIPTION	MODEL	PRICE
BLACK MIST		
	KNOBH116 L: 1 5/16" W: 1 1/4" P: 1 1/8" B: 3/8"	13
	PULLH115 C/C: 128mm L: 6 3/8" W: 1 1/2" P: 1"	28





BRONZE HIGHLIGHT		
	KNOBRH20 L: 1 7/16" W: 1 7/16" P: 1 3/32"	34
	PULLRH21 C/C: 3" L: 4 39/64" W: 25/32" P: 1 3/16"	17



CAST IRON		
	KNOBM1820 L: 1 5/16" W: 1 5/16" P: 1"	34
	PULLM1823 C/C: 5 1/16" L: 7 3/8" W: 1" P: 1 1/4"	39



D = Diameter
P = Projection (Hardware Depth)
L = Length
W = Width
B = Base
C/C = Center to Center

Installation screws included with each hardware piece.
 Breakoff screws available for purchase separately as BRKOFFSCREW, see page 177.
 Larger pulls may not be compatible with 5-piece drawer fronts on face frame openings of 9" wide or less.
 See page 26 for 5-piece drawer front dimensions when specifying decorative hardware.

DESCRIPTION	MODEL	PRICE
CHROME		
	KNOB1906 L: 1 1/16" W: 1 1/16" P: 1 1/8" B: 3/8"	37
	PULL1905 C/C: 128mm L: 6 3/8" W: 9/16" P: 1"	51
	PULL1904 C/C: 3 3/4" L: 5 1/4" W: 1" P: 1"	52







GOLD		
	KNOB1908 L: 1 1/4" W: 1 1/4" P: 1" B: 3/8" Pairs best with PULL1907	28
	PULL1907 C/C: 160mm L: 6 7/10" W: 2/5" P: 1 1/5" Pairs best with KNOB1908	46
	KNOB1909 L: 1 1/4" W: 1 1/4" P: 1 1/8" B: 3/4" Pairs best with PULL1910 or PULL1911	27
	PULL1910 C/C: 224mm L: 9 9/16" W: 3/4" P: 1 5/16" Pairs best with KNOB1909 or PULL1911	57
	PULL1911 C/C: 192mm L: 8 3/8" W: 3/4" P: 1 1/4" Pairs best with KNOB1909 or PULL1910	51

DESCRIPTION	MODEL	PRICE
HAMMERED BRONZE		
	KNOBH913 L: 1 3/8" W: 1 3/8"	33
	PULLH911 C/C: 3" L: 5 5/8" W: 1" P: 1 1/4"	35

ICE TEA		
	KNOBH108 L: 1 7/16" W: 1 1/16" P: 1" B: 1/2"	9
	PULLH144 C/C: 160mm L: 6 5/16" W: 9/16" P: 1 1/16"	20

D = Diameter
P = Projection (Hardware Depth)
L = Length
W = Width
B = Base
C/C = Center to Center



Installation screws included with each hardware piece.
Breakoff screws available for purchase separately as BRKOFFSCREW, see page 177.
Larger pulls may not be compatible with 5-piece drawer fronts on face frame openings of 9" wide or less.
See page 26 for 5-piece drawer front dimensions when specifying decorative hardware.

DESCRIPTION	MODEL	PRICE
SATIN NICKEL		
	KNOBT002 C/C: 1 1/4" L: 2" W: 3/8" P: 1 1/2" Pairs best with PULLT001	37
	PULLT001 C/C: 7" L: 8" W: 3/8" P: 1 1/2" Pairs best with KNOBT002	25
	PULLH120 C/C: 160mm L: 7 1/8" W: 3/4" P: 1" Pairs best with PULLH122	23
	PULLH122 C/C: 12" L: 12 3/4" W: 7/8" P: 1 3/16" Pairs best with PULLH120	44
	PULLH105 C/C: 1" L: 1 3/4" W: 1" P: 1 3/4" Pairs best with PULLH106 or PULLH107	29
	PULLH106 C/C: 160mm L: 7" W: 1" P: 1 3/4" Pairs best with PULLH105 or PULLH107	41
	PULLH107 C/C: 12" L: 13" W: 1" P: 1 13/16" Pairs best with PULLH105 or PULLH106	66



DESCRIPTION	MODEL	PRICE
SATIN NICKEL (cont'd)		
	KNOB1420 D: 1 1/4" P: 1 1/8"	16
	KNOBH100 D: 1 3/8" P: 1 3/8" B: 3/4"	16
	KNOBH118 L: 1 5/16" W: 1 5/16" P: 1 3/16" B: 7/8"	14
	KNOBM549 D: 7/8" P: 1"	15
	PULLH50 C/C: 5" L: 5" W: 5/16" P: 1 1/4"	41
	PULLH63 C/C: 96mm L: 4 1/8" W: 1/2" P: 1 1/16"	33
	PULLH957 C/C: 3" L: 4 1/4" W: 1 1/2" P: 11/16"	24







D = Diameter
P = Projection (Hardware Depth)
L = Length
W = Width
B = Base
C/C = Center to Center

Installation screws included with each hardware piece.
 Breakoff screws available for purchase separately as BRKOFFSCREW, see page 177.
 Larger pulls may not be compatible with 5-piece drawer fronts on face frame openings of 9" wide or less.
 See page 26 for 5-piece drawer front dimensions when specifying decorative hardware.

DESCRIPTION	MODEL	PRICE
SATIN NICKEL (cont'd)		
	PULLM381 C/C: 5 1/16" L: 6" W: 1/2" P: 1 1/16"	20
	PULLM430 C/C: 5 1/16" L: 7" W: 15/32" P: 1 7/16"	23
	PULLM570 C/C: 5 1/16" L: 5 7/8" W: 1/2" P: 1 3/16"	19

SILVER STONE

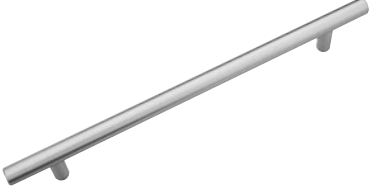
	KNOBH127 D: 1 1/2" P: 1" B: 7/8"	16
	PULLH128 C/C: 160mm L: 7 1/2" W: 3/4" P: 1 1/16"	25

DESCRIPTION	MODEL	PRICE
STAINLESS STEEL		
	KNOBH135 L: 1 3/4" W: 1/2" P: 1 1/8" B: 1/2" Pairs best with PULLH129 or PULLH131	12
	PULLH129 C/C: 128mm L: 6 3/8" W: 7/16" P: 1 1/8" Pairs best with KNOBH135 or PULLH131	14
	PULLH131 C/C: 224mm L: 10" W: 1/2" P: 1 3/8" Pairs best with KNOBH135 or PULLH129	22
	PULLH141 C/C: 128mm L: 7 3/8" W: 1/2" P: 1 1/4" Pairs best with PULLH142 or PULLH143	13
	PULLH142 C/C: 192mm L: 9 15/16" W: 1/2" P: 1 1/4" Pairs best with PULLH141 or PULLH143	15
	PULLH143 C/C: 384mm L: 17 1/2" W: 1/2" P: 1 1/4" Pairs best with PULLH141 or PULLH142	22

D = Diameter
P = Projection (Hardware Depth)
L = Length
W = Width
B = Base
C/C = Center to Center

Installation screws included with each hardware piece.
 Breakoff screws available for purchase separately as BRKOFFSCREW, see page 177.
 Larger pulls may not be compatible with 5-piece drawer fronts on face frame openings of 9" wide or less.
 See page 26 for 5-piece drawer front dimensions when specifying decorative hardware.

DESCRIPTION	MODEL	PRICE
TUSCAN BRONZE		
	KNOBH117 L: 1 5/16" W: 1 5/16" P: 1 3/16" B: 7/8" Pairs best with PULLH119	14
	PULLH119 C/C: 160mm L: 7 1/8" W: 3/4" P: 1" Pairs best with KNOBH117	35
	KNOBTO13 D: 1 1/4" P: 1 1/16"	29
	PULLM1674 C/C: 3" L: 4 5/8" W: 1 7/16" P: 15/16"	40
	PULLT1018 C/C: 5 1/16" L: 6" W: 1/2" P: 1 1/16"	27

Touch Latch 31

- Nylon gray mechanism with bumper tip.
- Face frame will need to be field drilled for insertion of the TOUCHLATCH, requires 25/64" (10mm) drill bit.
- Can be field adjusted for door gap depth, no tools required.
- For use on full/modified full overlay door styles only.
- Requires a soft touch to open the door, and door must be pushed closed to reset the TOUCHLATCH mechanism.
- Only for use on hinged doors, and can be used without decorative hardware. Not compatible with non-hinged doors. For drawers, pull-outs, and other non-compatible cabinets, PULLH105, PULLH106, and PULLH107 are recommended (see page 169).

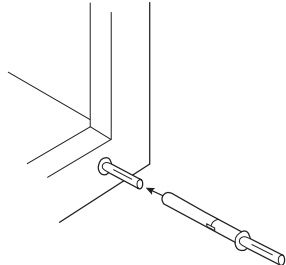

CabMat™

CABMAT30	208
CABMAT33	208
CABMAT36	208

- CabMat™ is designed to capture spills and is removable for cleaning.
- Not trimmable. Can also be used in wider cabinets but will create a small void of unprotected area along the end panels.

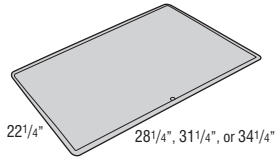

CabMat™ Vanity

CABMATV24	208
CABMATV30	208
CABMATV36	208

- CabMat™ is designed to capture spills and is removable for cleaning.
- Not trimmable. Can also be used in wider cabinets but will create a small void of unprotected area along the end panels.

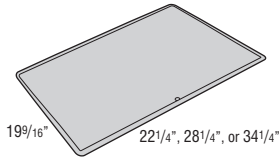

Cooking Utensil Divider

CUDD24	240
CUDD30	268
CUDD36	295

- Pre-assembled natural wood drawer insert.
- Only compatible with SoftTouch wood drawers.

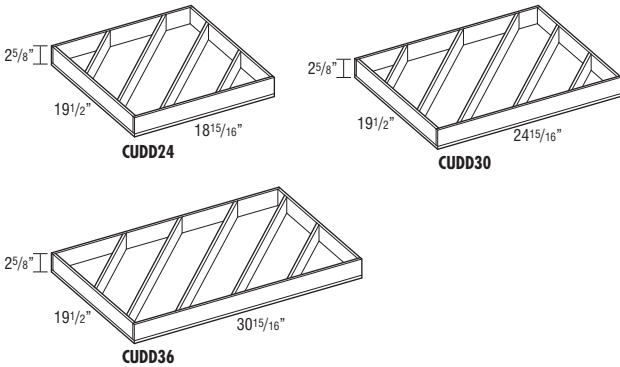

Cutlery Divider Wood Tiered Drawer

WTCD15	463
WTCD18	478
WTCD21	498
WTCD24	515

- Replaces standard drawer. Uses existing cabinet member drawer hardware.
- Only compatible with PG SoftTouch guide.
- Requires field installation of drawer front.
- For use with 24" deep cabinets only.
- Exterior WTCD drawer box height is 3 3/4", interior height of top tier is 1 5/8", and interior height of bottom tier is 1 3/8".
- Top divider slides front-to-back.

Model	Application
WTCD15	15" Base
WTCD18	18" Base
WTCD21	21" Base
WTCD24	24" Base

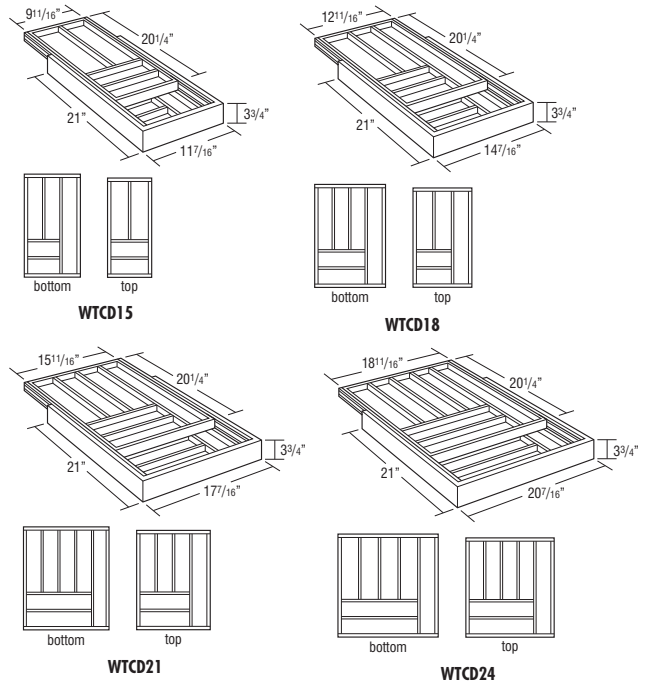

Cutlery Insert Wood Organizer

CIW15	173
CIW18	184
CIW21	239
CIW24	258

- Pre-assembled natural wood drawer insert.

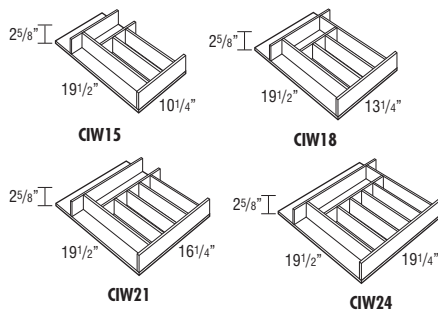

Model	Application
CIW15	15" Base
CIW18	18" Base
CIW21	21" Base
CIW24	24" Base

Exterior Shelves, 12" Deep

ES1218	143
ES1224	156
ES1230	170
ES1236	183
ES1248	216
ES1296	315

- 3/4" thick veneered furniture board finished both sides, and front and side edges (back edge is not finished).

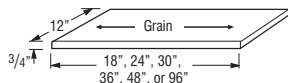

Modifications

APU	ID	RD
•	•	•

Glass Shelf Kit, 12" Deep

GSK1212	224
GSK1512	227
GSK1812	233
GSK2112	256
GSK2412	264
GSK2712	271
GSK3012	275
GSK3312	286
GSK3612	295

Glass Shelf Kit, Diagonal:

GSKWD24 (Fits WD2430-WD2442)	380
GSKWD27 (Fits WD2730-WD2742)	380

- GSK cannot be trimmed.
- Example: GSK1512 = 13 9/32" wide x 10 3/16" deep fits in W1530x12 cabinet.
- Kit includes two 1/4" glass shelves.
- Direct ship from manufacturer.
- The use of glass for base cabinet applications or for placement near interior or exterior doors is not recommended.

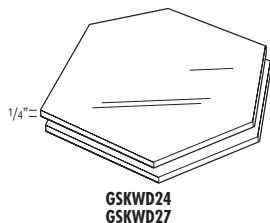
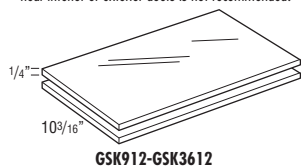

Full Depth Interior Shelves

SK912	65
SK1212	65
SK1512	65
SK1812	79
SK2112	79
SK2412	79
SK2712	92
SK3012	92
SK3312	92
SK3612	104
SK3912	104
SK4212	104
SK4812	119

SK924	83
SK1224	83
SK1524	83
SK1824	99
SK2124	99
SK2424	99
SK2724	111
SK3024	111
SK3324	111
SK3624	126
SK3924	126
SK4224	126
SK4824	138

- SK_12 includes one 10 1/2" deep shelf, SK_24 includes one 22 1/2" deep shelf.
- Each kit includes 8 shelf pegs.
- Full Depth Shelves will be shipped separate from the cabinet.
- RD not available on SK_12.

Modifications

APU	MI	RD
•	•	•

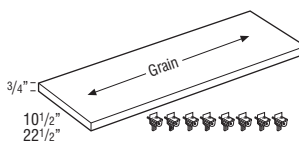

Straight Heat Shields

OHS	100
OHSS	120

- OHS is a pair of 1/16" thick, white metal shields.
- OHSS is a pair of 1/16" thick, stainless steel metal shields.
- Heat Shield is used to deflect heat from self-cleaning ovens away from cabinet doors and drawer fronts.
- For use when additional 1/8" can be added to the oven manufacturer's recommended space requirements.
- Installs on the side of the face frame of each cabinet adjacent to the oven.

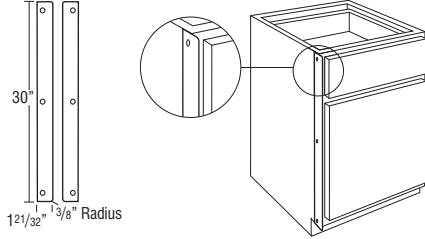

Oven Installation Kit

OVENINSTALLKIT	52
-----------------------	----

- Recommended for supporting built-in appliances such as ovens, microwaves, and warming drawers. Refer to appliance manufacturer specifications for installation requirements.
- Weight limit is 400 lbs. per pair.

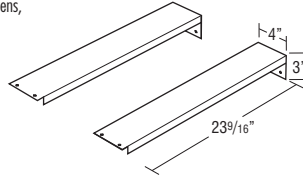

Pegged Dish Organizer

PDO (8 Pegs & Board)	345
PDOPOSTS (4 Pegs)	87

- Recommended for use in 36" wide Two Drawer Base (2BD) and Three Drawer Base (3BD) cabinets, trimmable for cabinets less than 36" wide. Not recommended for use in roll trays.
- Pegged Board is 3/8" thick.
- 29 15/16" x 19 1/2"

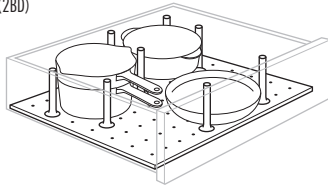

Spice Rack — Pull-down

SPD18	209
--------------	-----

- Spice Rack Pull-down dimensions: 8 15/16" high x 14 13/16" wide x 10 5/16" deep.
- Spice Rack Pull-down requires 3 3/4" below the bottom edge of the cabinet and 9 1/4" in front of the cabinet.
- For use in a minimum 15" wide opening (recommended for use in 18" wide cabinets).
- Maximum Weight Capacity: 15 lbs.
- Must be installed on the floor of the cabinet. Cannot be installed on an adjustable shelf.

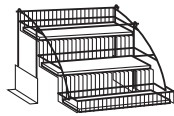

Tilt-out Trays, Plastic

TOT15	94
TOT18	98

- Kit includes 2 white trays and tilt-out hinges.
- SB39-SB48 have 2 fixed panels.
- SB30B-SB36B have 1 long fixed panel.
- SB21-SB27B may only accept one tray.

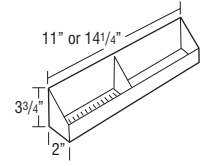

Model	Size	Application
TOT15	11" w x 2" d x 3 3/4" h	SB30B, SB33B
TOT18	14 1/4" w x 2" d x 3 3/4" h	SB21, SB24, SB24B, SB27B, SB36B, SB39, SB42, SB45, SB48

Tray Divider Kit

WTD	46
------------	----

- WTD: Includes 1 divider, 3 clips, and 3 screws.
- Tray divider is chrome.

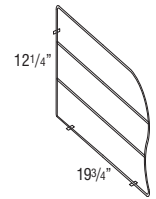

Tray Roll-out Divider

TDR012	291
TDR015	324

- TDR012: 2 removable dividers (3 compartments).
- TDR015: 3 removable dividers (4 compartments).
- Includes guides.
- 3/8" plywood construction.
- TDR012 fits B12.
- TDR015 fits B15.
- Not compatible with roll tray option.

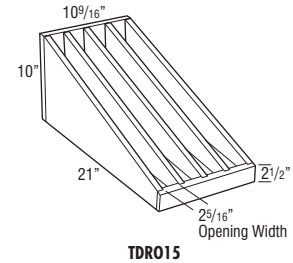
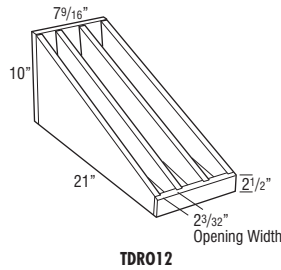

Wine Glass Holders

SWR30 (7 slots)	244
SWR36 (8 slots)	298

- Maximum wine glass base is 3" diameter.
- May be trimmed to fit smaller cabinets.

Species Availability

Hickory	Maple	Oak	Painted	Rustic Hickory	Laminate
•	•	•	•	•	Painted

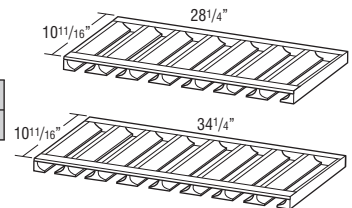

Roll Trays

RTF1224	108
RTF1524	113
RTF1824	123
RTF1924	129
RTF2124	134
RTF2224	139
RTF2424	144
RTF2724	149
RTF3024FW	154
RTF3324FW	159
RTF3624FW	165
• Laminate • RTF trays available in RD18 and RD21.	
RTPG1224	208
RTPG1524	213
RTPG1824	223
RTPG1924	229
RTPG2124	234
RTPG2224	239
RTPG2424	244
RTPG2724	249
RTPG3024FW	254
RTPG3324FW	259
RTPG3624FW	265

- Wood
- Includes cabinet and drawer members.
- RTPG trays have SoftTouch guides.
- RTPG trays available in RD12, RD15, RD18, and RD21.

Modifications

RD
•

Model	RTF Width	RTPG Width	Application
RT_1224	7 9/16"	7 3/4"	B12, U12
RT_1524	10 9/16"	10 3/4"	B15, B15RT, U15
RT_1824	13 9/16"	13 3/4"	B18, B18RT, U18
RT_1924	15 1/16"	15 1/4"	B39
RT_2124	16 9/16"	16 3/4"	B21, B21RT, U21, B42
RT_2224	18 1/16"	18 1/4"	B45
RT_2424	19 9/16"	19 3/4"	B24, B24RT, U24, B48
RT_2724	22 9/16"	22 3/4"	B27B, B27BRT, U27
RT_3024	25 9/16"	25 3/4"	B30B, B30BRT, U30
RT_3324	28 9/16"	28 3/4"	B33B, B33BRT, U33
RT_3624	31 9/16"	31 3/4"	B36B, B36BRT, U36

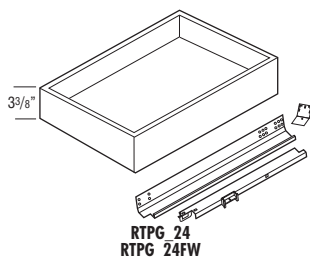
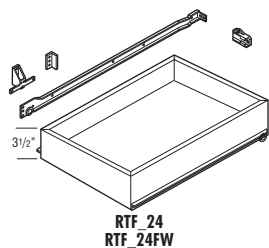

PURE&SIMPLE™ Cabinet Care Kit

CABCLEANKIT

47

- PURE&SIMPLE™ Cabinet Care Kit includes one 16 ounce spray bottle of cleaning solution and a small microfiber cloth.
- Safe for use on wood cabinet surfaces.



Stain, Paint, and Touch-up Tools

STAINQUART	97
PAINTQUART	150
SPRAYPAINT	68
SSCCLEAR	55
TK	49
MTUK	29
GLAZEPEN 	68

- SPRAYPAINT and SSCCLEAR are 384 mL aerosol cans available in Paints and PureStyle™ colors and clear.
- Touch-up Kit includes a full size touch-up marker and a full size fill stick. No glaze pen included with glaze finishes.
- Mini Touch-up Kit includes a small touch-up marker and a small fill stick. No glaze pen included with glaze finishes.
- GLAZEPEN available in glaze colors only.
- GLAZEPEN works on finished doors and does not require a separate top coat.

Guide Kits and Parts

DGKIT21DDFD	248
--------------------	-----

DGKIT24DDFD	248
--------------------	-----

- Side-mount progressive full extension guide utilized on all drawers of DDFD_ _ cabinets.
- 125 lb. weight capacity per pair.
- Kit includes guide hardware for one drawer box (cabinets and drawer members, mounting rails, and screws).
- Dimension refers to cabinet depth.

DGKIT12PG	224
------------------	-----

DGKIT15PG	224
------------------	-----

DGKIT18PG	224
------------------	-----

DGKIT21PG	224
------------------	-----

DGKIT24PG	224
------------------	-----

- Undermount full extension Softouch Premium Guide.
- 75 lb. weight capacity per pair.
- Kit includes guide hardware for one drawer box (cabinets and drawer members, sockets and screws).
- Dimension refers to cabinet depth.

DGKIT18FDRW	35
--------------------	----

DGKIT21FDRW	35
--------------------	----

DGKIT24FDRW	35
--------------------	----

- Furniture board drawer side-mount guide used on drawers with FDRW modification.
- 75 lb. weight capacity per pair.
- Kit includes guide hardware for one drawer box (cabinets and drawer members, sockets and screws).
- Dimension refers to cabinet depth.

DGKIT12RTPG	224
--------------------	-----

DGKIT15RTPG	224
--------------------	-----

DGKIT18RTPG	224
--------------------	-----

DGKIT21RTPG	224
--------------------	-----

DGKIT24RTPG	224
--------------------	-----

- Undermount full extension Softouch Premium Guide.
- 75 lb. weight capacity per pair.
- Kit includes guide hardware for one drawer box (cabinets and drawer members, sockets and screws).
- Dimension refers to cabinet depth.

DGKIT18RTF	35
-------------------	----

DGKIT21RTF	35
-------------------	----

DGKIT24RTF	35
-------------------	----

- Side-mount guide used on roll trays with FDRW modification.
- 3/4 extension.
- 75 lb. weight capacity per pair.
- Kit includes guide hardware for one drawer box (cabinets and drawer members, sockets and screws).
- Dimension refers to cabinet depth.

Drawer Guide Back Sockets

BKSOCKETPG12	43
---------------------	----

BKSOCKETPG	43
-------------------	----

BKSOCKETRTPG	43
---------------------	----

BKSOCKETFDRW	43
---------------------	----

- BKSOCKETPG12 used with Softouch drawer guides and roll tray guides (12" deep).
- BKSOCKETPG used with Softouch drawer guides (15"-24" deep).
- BKSOCKETRTPG used with Softouch roll tray guides (15"-24" deep).
- BKSOCKETFDRW used with side-mount drawer guides (FDRW modification).
- Sold in pairs.

Drawer Guide Box Locking Clips

PG12LOCKCLIP	36
---------------------	----

PG12LOCKCLPNRW	36
-----------------------	----

PGLOCKCLIP	36
-------------------	----

PGLOCKCLIPNRW	36
----------------------	----

- PG12LOCKCLIP used with Softouch drawer guides (12" deep).
- PG12LOCKCLPNRW used with Softouch drawer guides on cabinets with drawers with a face frame opening of 7 1/2" or less (12" deep).
- PGLOCKCLIP used with Softouch drawer guides (15"-24" deep).
- PGLOCKCLIPNRW used with Softouch drawer guides on cabinets with drawers with a face frame opening of 7 1/2" or less (15"-24" deep).
- Sold in pairs.

False Panel Clips

FIXEDFRTCLIP5	8
----------------------	---

PFIXEDFRTCLIP5	8
-----------------------	---

- Clips come in pairs of two.
- Use to secure false front on sink base.

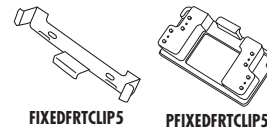
**Roll Tray Plug In Brackets**

RTFSPACER	44
------------------	----

RTPGSPACER	42
-------------------	----

- For use with roll tray hardware to prevent interference with door hinges. Also included in roll tray hardware kit.
- RTFSPACER for use with roll trays with FDRW modification.
- RTPGSPACER for use with standard roll trays.
- Includes four end panel brackets, two vertical stile brackets, and screws.

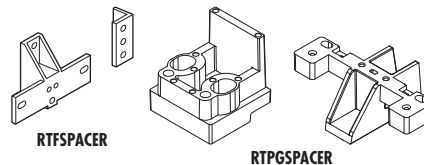

Hinges

INTGHPHINGE

27

- Integrated SoftTouch.
- 6-way adjustable.
- 1/2" Traditional overlay 107° hinge.
- For use on all Traditional overlay cabinets not specified by other hinges.
- For use on full overlay styles: Angle Base Cabinets, Diagonal Wall and Base Cabinets, and 36" Corner Sink Bases and Fronts.
- Sold in pairs.

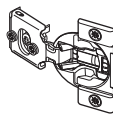

INTGHFOHINGE

27

- Integrated SoftTouch.
- 6-way adjustable.
- Full overlay 107° hinge.
- For use on all full overlay cabinets not specified by other hinges.
- Sold in pairs.

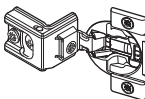

INTGHSRFMTHG

27

- Integrated SoftTouch.
- 4-way adjustable.
- Full overlay face-mount 107° hinge.
- For use on OSB, OD and OMC, and 36"-42" high WBMW cabinets.
- Sold in pairs.

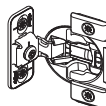

PO.5HINGE

20

- 6-way adjustable.
- 1/2" Traditional overlay 107° hinge.
- For use on full overlay styles with NSCH modification: Angle Base Cabinets, Diagonal Wall and Base Cabinets, and 36" Corner Sink Bases and Fronts.
- Sold in pairs.

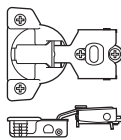

FO1.25HINGE

20

- 6-way adjustable.
- Full overlay 107° hinge.
- For use on all full overlay cabinets with NSCH modification and not specified by other hinges.
- Sold in pairs.

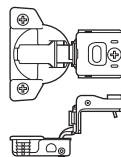

SURFMTHINGE

11

- 4-way adjustable.
- Full overlay face-mount 107° hinge.
- For use on OSB, OD and OMC, and 36"-42" high WBMW cabinets with NSCH modification.
- Sold in pairs.



BERDR-DRHINGE

70

- 90° Corner Self-closing Center Hinge.
- For use as center hinge on BLS, BC, BER, and WCER cabinets.
- Sold in pairs.

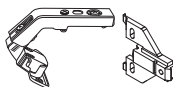

BERDR-FRMHINGE

60

- 170° Hinge.
- For use on BSC, BLS, BC, BER, and WCER cabinets.
- Sold in pairs.



MIRRORHINGE

11

- Mirror hinge.
- For use on TV and MC cabinets.
- Sold in pairs.



Hinge Angle Restriction Clip

INTGHRSTRCLIP

11

- For use in applications with cabinets installed at varying depths to prevent the door damage caused by opening into an adjacent cabinet.
- Restricts hinges to 86° opening capability.
- Works only with the INTGHPHINGE and INTGHFOHINGE.
- Not recommended for cabinets with roll trays specified in Traditional overlay styles.
- Sold in pairs.



Hinge Shim

HINGESPACER

16

- Install between the face frame and hinge to allow additional adjustment of doors. Can be used to reduce gap between butt doors.
- Each shim is 1/32" thick and can be stacked to achieve desired overlay reduction.
- Pack of 5 metal shims.
- Compatible with all hinges except face-mount.



Miscellaneous Parts

BRKOFFSCREW (pkg. 25)	6
DOORBUMPER25 (pkg. 25)	7
GLASSRETCLIP	17
INSTLSCREW4 (pkg. 4)	5
INSTLSCREW100 (pkg. 100)	18
SHELFCLIP24 (pkg. 24)	11

- BRKOFFSCREW is a pack of 25 breakaway screws for use with decorative hardware pulls and knobs.
- GLASSRETCLIP: 6 retainer clips for use with glass inserts in mullion and cut-for-glass doors.
- INSTLSCREW4 and INSTLSCREW100 are screws for cabinet installation through the cabinet back to the wall studs (includes a pack of 4 or 100).
- SHELFCLIP24 are 3mm steel pins with clear plastic shoulders.

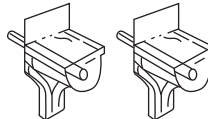

SHELFCLIP24

Doors and Drawer Fronts

Door For Any Cabinet Less Than 18" High	252
Door For Any Cabinet 18" To 30" High	316
Door For Any Cabinet Over 30" High	444
Any Drawer Front Only*	117

*Drawer front option upcharge applied where applicable.

Drawers

Furniture Board Drawer With Drawer Front*	154
Furniture Board Drawer Box Only*	134
Wood Drawer With Drawer Front*	186
Wood Drawer Box Only*	166

- All applicable modification and premium finish upcharges will apply.
- *Drawer assemblies include the Drawer box, Drawer front, and Drawer guides. Order cabinet member guides separately. WDRW box has fixing clips attached, guides and parts must be ordered separately.

DADOOR

\$150/sq ft

- Includes a 3/4" thick door made to a custom size.
- All doors will be specified "NO HINGE ROUTE". Backs may have identification marks, be unfinished, and have 3/16" diameter holes used during finish processing. For these reasons, these doors are not suitable for use as cabinet doors.
- Custom Doors not available in Chalet, Fyfer, or Piper. Limitations exist on all styles.
- Custom sizes available in 1/32" increments.
- CG modification available.
- Custom dimensions are required when placing the order.
- Custom doors are not available for cabinets not manufactured by Homecrest.

178

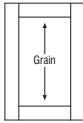
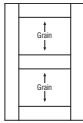
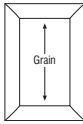
	Model	Door Style Type	Available Width Range*	Available Height Range*
	DADOOR	Non-Miter Styles	7 1/2" to 25 7/8" (<3" wide rails/stiles) 8 1/2" to 25 7/8" (3" wide rails/stiles)	7 1/2" to 47 15/32" (<3" wide rails/stiles) 8 1/2" to 47 15/32" (3" wide rails/stiles)
	DADOOR (Dover)	Non-Miter Styles	8 1/2" to 24" (3" wide rails/stiles)	8 1/2" to 42" (3" wide rails/stiles)
	DADOOR (Welzin & Wexford)	Non-Miter Styles	7 1/2" to 23" (<3" wide rails/stiles)	7 1/2" to 42" (<3" wide rails/stiles)
	DADOOR	Non-Miter Styles	7 1/2" to 25 7/8" (<3" wide rails/stiles) 8 1/2" to 25 7/8" (3" wide rails/stiles)	47 1/2" to 70" (<3" wide rails/stiles) 47 1/2" to 70" (3" wide rails/stiles)
	DADOOR (Dover)	Non-Miter Styles	8 1/2" to 24" (3" wide rails/stiles)	47 1/2" to 70" (3" wide rails/stiles)
	DADOOR (Welzin & Wexford)	Non-Miter Styles	7 1/2" to 23" (<3" wide rails/stiles)	47 1/2" to 70" (<3" wide rails/stiles)
	DADOOR	Miter Styles	8" to 25 7/8"	8" to 70"

*Any door with a minimum width or height dimension less than 10" will receive a flat center panel.

Custom Doors with Hinge Routing

DOORHNG

\$150/sq ft

- Hinges must be ordered separately and specified full or traditional overlay.
- Custom Doors not available in Châlet, Fyfer, or Piper. Limitations exist on all styles.
- Doors are finished on both sides and routed for hinges. Plastic mollies are pressed in 8mm holes to accept screws to anchor the hinges to the back of these doors.
- CG modification available.
- Custom dimensions are required when placing the order.
- Custom doors are not available for cabinets not manufactured by Homecrest.

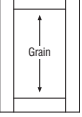
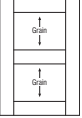
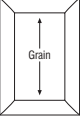
	Model	Door Style Type	Available Width Range*	Available Height Range
	DOORHNG	Non-Miter Styles	7 1/2" to 24" (<3" wide rails/stiles)	10" to 47 15/32" (<3" wide rails/stiles)
	DOORHNG (Dover)	Non-Miter Styles	8 1/2" to 24" (3" wide rails/stiles)	10" to 47 15/32" (3" wide rails/stiles)
	DOORHNG (Welzin & Wexford)	Non-Miter Styles	7 1/2" to 23" (<3" wide rails/stiles)	10" to 42" (<3" wide rails/stiles)
	DOORHNG	Non-Miter Styles	7 1/2" to 24" (<3" wide rails/stiles)	47 1/2" to 70" (<3" wide rails/stiles)
	DOORHNG (Welzin & Wexford)	Non-Miter Styles	8 1/2" to 24" (3" wide rails/stiles)	47 1/2" to 70" (3" wide rails/stiles)
	DOORHNG	Miter Styles	8" to 24"	10" to 70"

*Any door with a minimum width dimension less than 10" will receive a flat center panel.

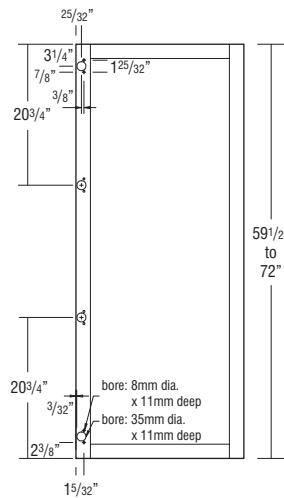
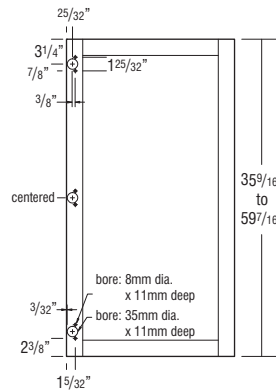
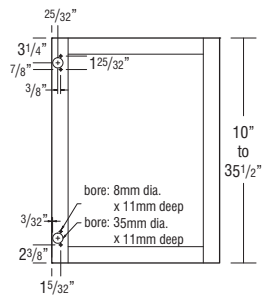

PAINT FINISH AWARENESS AGREEMENT



Thank you for choosing a paint finish from Homecrest Cabinetry. Because your satisfaction is important to us, we want you to be aware of the unique characteristics of painted finishes that may be quite different from other cabinetry finishes.

Characteristics of Paint Finishes

Paint finishes are different from standard wood finishes. On all wood products, expansion and contraction are typical due to changes in climate conditions. Due to this normal movement, paint finishes may develop slight separation lines, finish breaks and seam lines. These will be most notable at stile, rail and panel joints. Joint separations may become more noticeable over time and through season changes.

All paint finishes first receive a primer coat designed to provide optimum fill and leveling of the surface. This provides an even base for the color and finish coats.

Seam lines and finish breaks are normal characteristics of paint finishes and should not be considered a reason for product replacement. Over time, there may be a slight color shift in the finish, due to exposure to natural and artificial light.



Example of door front joint separation



Example of door front joint separation



Example of door end joint separation

I have read and understand the statements above and agree that the characteristics of paint finishes from Homecrest Cabinetry are acceptable. I understand that neither Homecrest Cabinetry or the Homecrest Cabinetry Dealer listed below is responsible in the event that these characteristics are later found to be less desirable than expected.

Customer Signature

Dealer Signature

Customer Name (please print)

Dealer Name (please print)

Dealer Purchase Order Number

**This completed form must accompany your product order.
Orders for Paint finishes will not be confirmed without a signed agreement.**

RUSTIC HICKORY DESCRIPTION AGREEMENT



Congratulations on your selection of Homecrest cabinetry in Rustic Hickory. Because of its unique characteristics Rustic Hickory is quite different from other wood types you may be familiar with. Your satisfaction is important to us, and we want you to fully understand the characteristics that make Rustic Hickory so distinctive.

It is important to realize that the beauty of wood cabinetry comes from the natural qualities of wood itself. Rustic Hickory is characterized by its nearly white to dark brown dramatic color variations with wild flowing green patterns and may contain a variety of pin holes, open and closed knots of various sizes and colors, small cracks, bird pecks, mineral streaks, and grain variation. Some knots may have small holes through the panel. In addition, the wood will contain color difference caused by variations in minerals found in the soil, creating visible mineral tracks. However, those characteristics that might compromise the structural integrity of the door will not be included.

Sound Closed Knot (not moveable) – Expected in Rustic Hickory up to approximately 3” diameter.

Sound Knot with Cracks – Expect sound knots with open cracks up to approximately 1” in length.

Open Knot (through door) – Expected in Rustic Hickory with open area up to approximately 3/4” diameter.

Note: 3/4” diameter is about the size of a penny. Holes created by open knots pass completely through the door and are desirable for this rustic look.

Unsound Knot (moveable core) – Not to be expected.

Knot Cluster (cluster of tight sound knots) – To be expected in Rustic Hickory.

Worm Holes/Pin Holes (can go through door) – Can be expected on Rustic Hickory up to approximately 1/4” diameter.

Worm Tracks – Can be expected on Rustic Hickory in sizes up to approximately 1/8” wide by 8” long.

Rustic Hickory as described is featured for doors and drawer fronts. Other areas of the product will utilize standard Hickory. Customers should expect a much lower occurrence of rustic characteristics in these other areas. Also, the natural characteristics mentioned occur randomly in Rustic Hickory. All doors and drawer fronts will contain some combination of the common Rustic Hickory markings; however, it will be uncommon to find all markings on any single piece.

The natural characteristics of wood described above and variations in grain patterns and color are not considered reasons for product replacement. We mention these characteristics because neither Homecrest nor your Homecrest dealer can be responsible for these conditions and variations.

Accordingly, we ask that the following agreement be signed for Rustic Hickory orders.

I have read the foregoing and find the characteristic variations of wood with Rustic Hickory are desirable.

As such, I agree not to hold Homecrest and/or the Homecrest dealer listed below responsible in the event that these characteristics are later found by me to be less desirable than I had expected.

Customer Signature

Dealer Signature

Customer Name (please print)

Dealer Name (please print)

Dealer Purchase Order Number

NOTES

NOTES



Homecrest® Express Response™ Program

Our commitment to Channel Partners, Designers and Customers

Purpose: The Homecrest® Express Response program is used to expedite orders when customers need product faster than normal lead time to correct issues with an existing order. Below is an overview of the Express Response program and what you can expect from the Homecrest commitment to superior service.

Express Response Guidelines

- Eligible orders must be associated with a previous order number.
- Lead time calculation is based on receipt of a clean order. Clean orders are orders in which all information is provided and accurate.
- There is no additional upcharge for Express Response.
- There are no cancellations or returns once an Express Response order is received.
- Due to the nature of special orders and appliance panels, they are excluded from Express Response and will be processed as a standard lead time order.
- Express Response is available within the continental United States. Should Alaska, Hawaii or international shipments be required, customer service representatives are ready to assist by providing shipping information and determining lead times.

Lead Times

15 business days or less from order to delivery (channel partner):

- Items shipped via LTL, Parcel ground or truckload

Questions? If you have questions that aren't answered here, contact your Customer Service team.

Discontinued Product Policy

60 days minimum notice to customers announcing the discontinuation of a product line.

Product will no longer be available for order after the discontinuation date. Only warranty orders will be considered. Even with warranty orders we will have the option to replace customer's defective product with the same discontinued product they originally purchased, or replace all doors originally ordered with a current product that is similar in appearance.

HOMECREST® DOOR STYLE PRICING REFERENCE

Price Point Order

Style	Specie	Price Column
Arbor	Hickory	1
Arbor	Oak	1
Kenosha	Hickory	1
Kenosha	Oak	1
Arbor	Maple	2
Arbor	Painted Hardwood	2
Arbor	Rustic Hickory	2
Arbor	PureStyle	2
Joplin	Oak	2
Kenosha	Maple	2
Kenosha	Painted Hardwood	2
Lautner	Hickory	2
Fyfer	Hickory	3
Fyfer	Oak	3
Joplin	Maple	3
Joplin	Painted Hardwood	3
Kendrick	Hickory	3
Kendrick	Oak	3
Lautner	Maple	3
Lautner	Painted Hardwood	3
Bishop	Oak	4
Wexford	Hickory	5
Wexford	Oak	5
Bexley	Hickory	6
Bishop	Maple	6
Bishop	Painted Hardwood	6
Chalet	Maple	6
Chalet	Painted Hardwood	6
Chalet	PureStyle	6
Darwyn	Hickory	6
Darwyn	Oak	6
Fyfer	Maple	6
Fyfer	Painted Hardwood	6
Kendrick	Maple	6
Kendrick	Painted Hardwood	6
Piper	Hickory	6
Piper	Oak	6
Sedona	Hickory	6
Sedona	Oak	6
Waldron	Hickory	6
Waldron	Oak	6
Bexley	Maple	7
Bexley	Painted Hardwood	7
Darwyn	Maple	7
Darwyn	Painted Hardwood	7
Darwyn	Rustic Hickory	7
Darwyn	PureStyle	7
Dover	Hickory	7
Dover	Oak	7
Piper	Maple	7
Piper	Painted Hardwood	7
Rosedale	Maple	7
Rosedale	Painted Hardwood	7
Sedona	Painted Hardwood	7
Sedona	Maple	7
Sedona	Painted Hardwood	7
Sedona	Rustic Hickory	7
Sedona	PureStyle	7
Waldron	Maple	7
Waldron	Painted Hardwood	7
Waldron	PureStyle	7
Welzin	Hickory	7
Welzin	Oak	7
Wexford	Maple	7
Wexford	Painted Hardwood	7
Wexford	Rustic Hickory	7
Dover	Maple	8
Dover	Painted Hardwood	8
Dover	Rustic Hickory	8
Highland	Maple	8
Highland	Painted Hardwood	8
Welzin	Maple	8
Welzin	Painted Hardwood	8

Alphabetical Order

Style	Specie	Price Column
Arbor	Hickory	1
Arbor	Maple	2
Arbor	Oak	1
Arbor	Painted Hardwood	2
Arbor	Rustic Hickory	2
Arbor	PureStyle	2
Bexley	Hickory	6
Bexley	Maple	7
Bexley	Painted Hardwood	7
Bishop	Maple	6
Bishop	Oak	4
Bishop	Painted Hardwood	6
Chalet	Maple	6
Chalet	Painted Hardwood	6
Chalet	Laminate	6
Darwyn	Hickory	6
Darwyn	Maple	7
Darwyn	Oak	6
Darwyn	Painted Hardwood	7
Darwyn	Rustic Hickory	7
Darwyn	PureStyle	7
Dover	Hickory	7
Dover	Maple	8
Dover	Oak	7
Dover	Painted Hardwood	8
Dover	Rustic Hickory	8
Fyfer	Hickory	3
Fyfer	Maple	6
Fyfer	Oak	3
Fyfer	Painted Hardwood	6
Highland	Maple	8
Highland	Painted Hardwood	8
Joplin	Maple	3
Joplin	Oak	2
Joplin	Painted Hardwood	3
Kendrick	Hickory	3
Kendrick	Maple	6
Kendrick	Oak	3
Kendrick	Painted Hardwood	6
Kenosha	Hickory	1
Kenosha	Maple	2
Kenosha	Oak	1
Kenosha	Painted Hardwood	2
Lautner	Hickory	2
Lautner	Maple	3
Lautner	Painted Hardwood	3
Piper	Hickory	6
Piper	Maple	7
Piper	Oak	6
Piper	Painted Hardwood	7
Rosedale	Maple	7
Rosedale	Painted Hardwood	7
Sedona	Hickory	6
Sedona	Maple	7
Sedona	Oak	6
Sedona	Painted Hardwood	7
Sedona	Rustic Hickory	7
Sedona	PureStyle	7
Waldron	Hickory	6
Waldron	Maple	7
Waldron	Oak	6
Waldron	Painted Hardwood	7
Waldron	PureStyle	7
Welzin	Hickory	7
Welzin	Maple	8
Welzin	Oak	7
Welzin	Painted Hardwood	8
Wexford	Hickory	5
Wexford	Maple	7
Wexford	Oak	5
Wexford	Painted Hardwood	7
Wexford	Rustic Hickory	7

LIMITED
LIFETIME
WARRANTY



VISIT US AT: [HOMECRESTCABINETRY.COM](https://www.homecrestcabinetry.com)

All orders taken are subject to approval by Homecrest and, after acceptance, are not subject to change without our consent. Homecrest carefully inspects and packages all merchandise and will ship via the best transportation facility available as it determines.

Any claim for transportation damage must be handled with the carrier.

No merchandise returns to Homecrest Cabinetry without prior written approval.

Styles, product availability and construction may vary slightly from those shown in this book due to material availability and/or design evolution. Specifications are subject to change without notice. Customer service is available if your design requires verification of product availability and specifications.

When Hardwood is painted, cabinet components, doors and/or drawer fronts may be constructed of various hardwood materials and/or composite materials such as Medium Density Fiberboard (MDF) and/or High Density Fiberboard (HDF).

Homecrest® has a Limited Lifetime Warranty.

For terms and conditions, please visit <https://www.homecrestcabinetry.com/warranty>

Prices effective 8.21.2023

Front Cover: Rosedale Painted Alpine
Island: Rosedale Maple Derby

MasterBrand Customer Service Operating Hours:
Mon-Fri, 8:00AM - 6:00PM EST
MasterBrand Customer Service Phone: 1.855.722.2148
MasterBrand Customer Service Fax: 1.800.737.1500

Designer ID#: _____

Customer Account #: _____

Sales Rep: _____

HOMECREST
C A B I N E T R Y



[homecrestcabinetry.com](https://www.homecrestcabinetry.com)
#homecrestcabinetry
©2023 MasterBrand Cabinets LLC
All rights reserved.

HCPRSPEC0823 2023-07/WDS/6.9M